



5SDD 24F2800

Old part no. DV 818-2480-28

Rectifier Diode

Properties

- Industry standard housing
- Suitable for parallel operation
- High operating temperature
- Low forward voltage drop

Key Parameters

V_{RRM}	=	2 800	V
I_{FAVm}	=	2 596	A
I_{FSM}	=	30 000	A
V_{TO}	=	0.906	V
r_T	=	0.135	mΩ

Types

	V_{RRM}
5SDD 24F2800	2 800 V
Conditions:	$T_j = -40 \div 160 \text{ }^\circ\text{C}$, half sine waveform, $f = 50 \text{ Hz}$

Mechanical Data

F_m	Mounting force	$22 \pm 2 \text{ kN}$
m	Weight	0.49 kg
D_s	Surface creepage distance	33 mm
D_a	Air st ike distance	20 mm

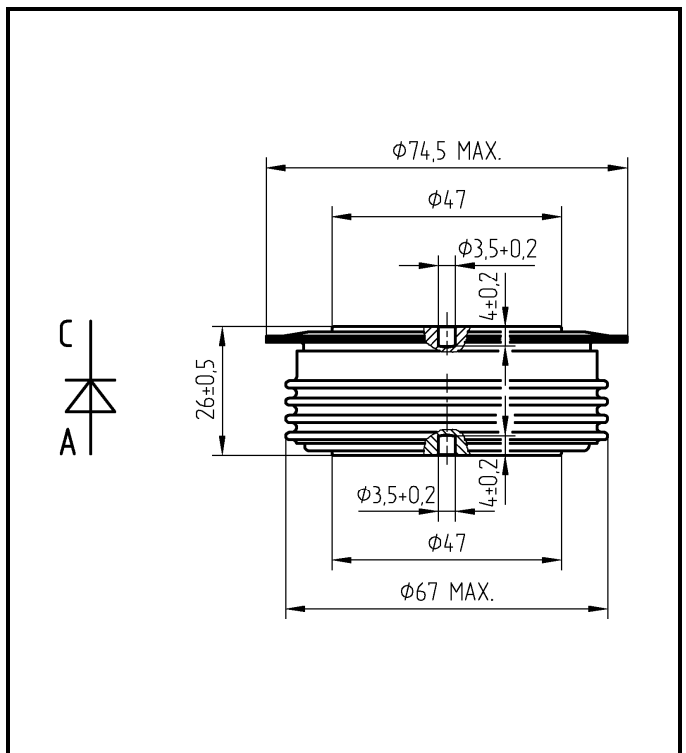

Fig. 1 Case



ABB s.r.o.

Novodvorska 1768/138a, 142 21 Praha 4, Czech Republic

tel.: +420 261 306 250, <http://www.abb.com/semiconductors>

Maximum Ratings		Maximum Limits	Unit	
V_{RRM}	Repetitive peak reverse voltage $T_j = -40 \div 160 \text{ }^\circ\text{C}$	2 800	V	
I_{FAVm}	Average forward current $T_c = 85 \text{ }^\circ\text{C}$	2 596	A	
I_{FRMS}	RMS forward current $T_c = 85 \text{ }^\circ\text{C}$	4 078	A	
I_{RRM}	Repetitive reverse current $V_R = V_{RRM}$	50	mA	
I_{FSM}	Non repetitive peak surge current $V_R = 0 \text{ V, half sine pulse, } T_j = 25 \text{ }^\circ\text{C}$	$t_p = 8.3 \text{ ms}$	38 500	A
		$t_p = 10 \text{ ms}$	36 000	A
	Non repetitive peak surge current $V_R = 0 \text{ V, half sine pulse}$	$t_p = 8.3 \text{ ms}$	32 000	A
		$t_p = 10 \text{ ms}$	30 000	A
$\int i^2 t$	Limiting load integral $V_R = 0 \text{ V, half sine pulse, } T_j = 25 \text{ }^\circ\text{C}$	$t_p = 8.3 \text{ ms}$	6 137 540	A²s
		$t_p = 10 \text{ ms}$	6 480 000	A²s
	Limiting load integral $V_R = 0 \text{ V, half sine pulse}$	$t_p = 8.3 \text{ ms}$	4 262 180	A²s
		$t_p = 10 \text{ ms}$	4 500 000	A²s
$T_{jmin} - T_{jmax}$	Operating temperature range	-40 \div 160	°C	
T_{STG}	Storage temperature range	-40 \div 160	°C	

Unless otherwise specified $T_j = 160 \text{ }^\circ\text{C}$

Characteristics		Value			Unit
		<i>min</i>	<i>typ</i>	<i>max</i>	
V_{T0}	Threshold voltage			0.906	V
r_T	Forward slope resistance $I_{F1} = 3\,140 \text{ A, } I_{F2} = 9\,420 \text{ A}$			0.135	mΩ
V_{FM}	Maximum forward voltage $I_{FM} = 4\,000 \text{ A}$			1.46	V
Q_{rr}	Recovered charge $V_R = 100 \text{ V, } I_{FM} = 1000 \text{ A, } di/dt = -30 \text{ A}/\mu\text{s}$		3000	3500	μC

Unless otherwise specified $T_j = 160 \text{ }^\circ\text{C}$

ABB s.r.o., Novodvorska 1768/138a, 142 21 Praha 4, Czech Republic

Thermal Parameters			Value	Unit
R_{thjc}	Thermal resistance junction to case	double side cooling	15	K/kW
		anode side cooling	24	
		cathode side cooling	40	
R_{thch}	Thermal resistance case to heatsink	double side cooling	4	K/kW
		single side cooling	8	

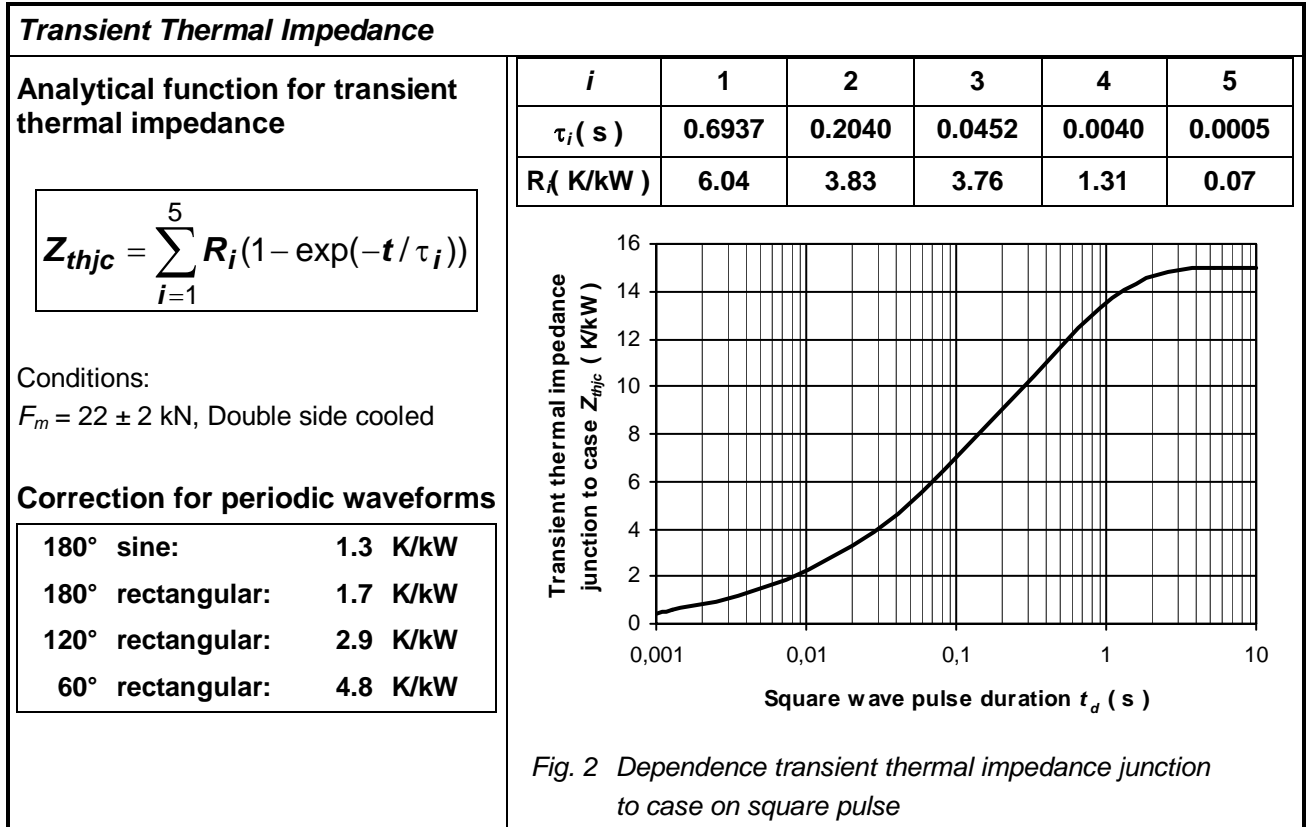

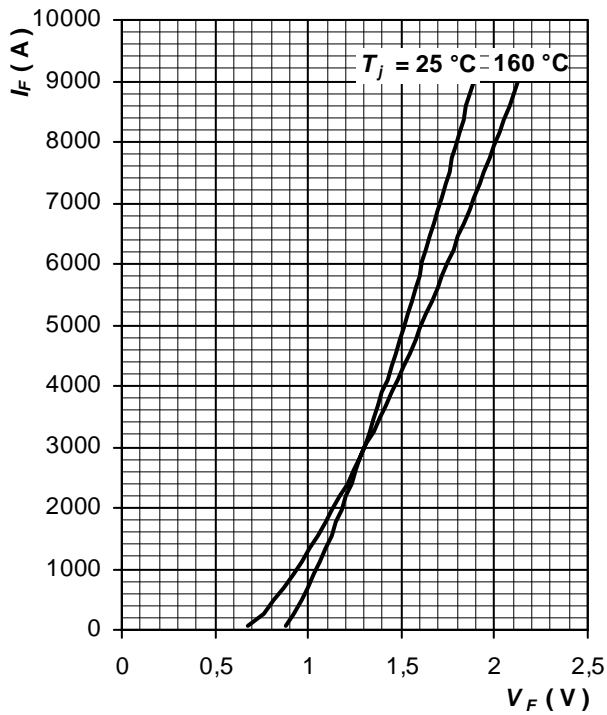

Fig. 3 Maximum forward voltage drop characteristics

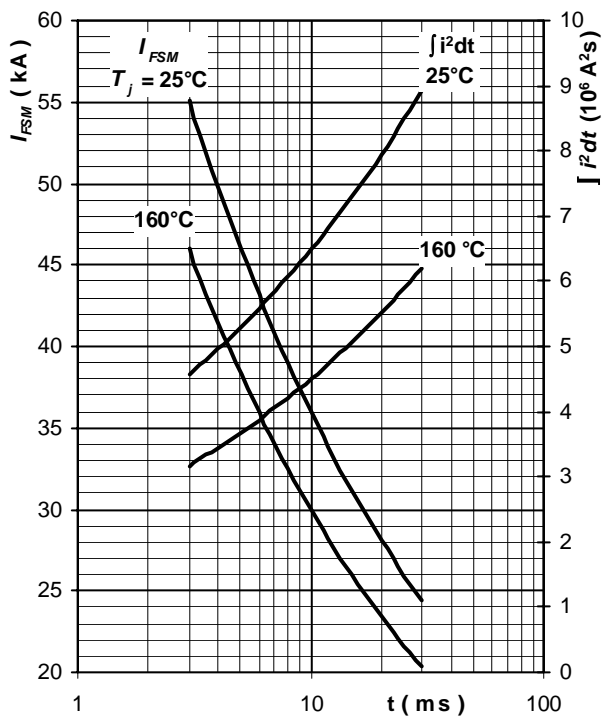

Fig. 4 Surge forward current vs. pulse length, half sine wave, single pulse, $V_R = 0 \text{ V}$, $T_j = T_{jmax}$

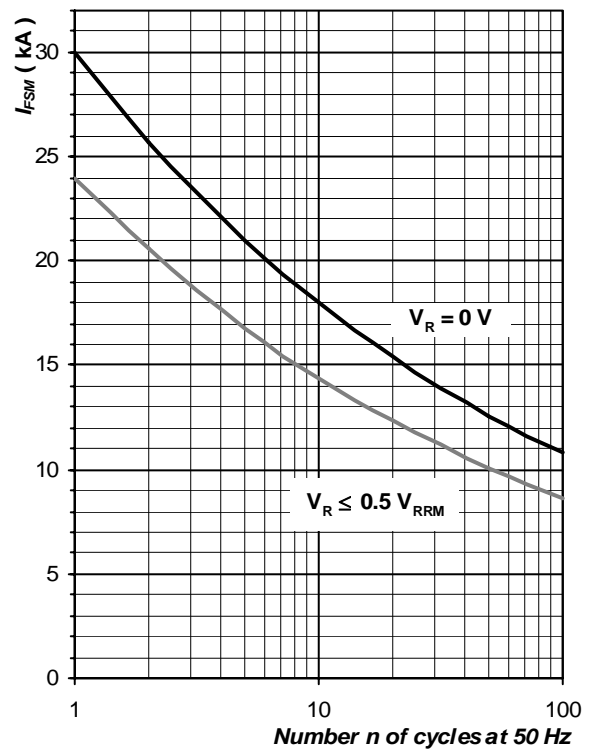

Fig. 5 Surge forward current vs. number of pulses, half sine wave, $T_j = T_{jmax}$

ABB s.r.o., Novodvorska 1768/138a, 142 21 Praha 4, Czech Republic

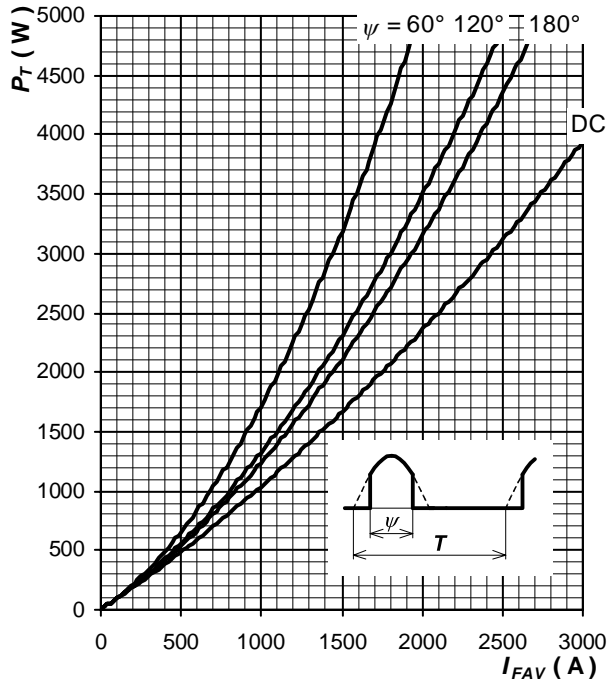

Fig. 6 Forward power loss vs. average forward current, sine waveform, $f = 50 \text{ Hz}$, $T = 1/f$

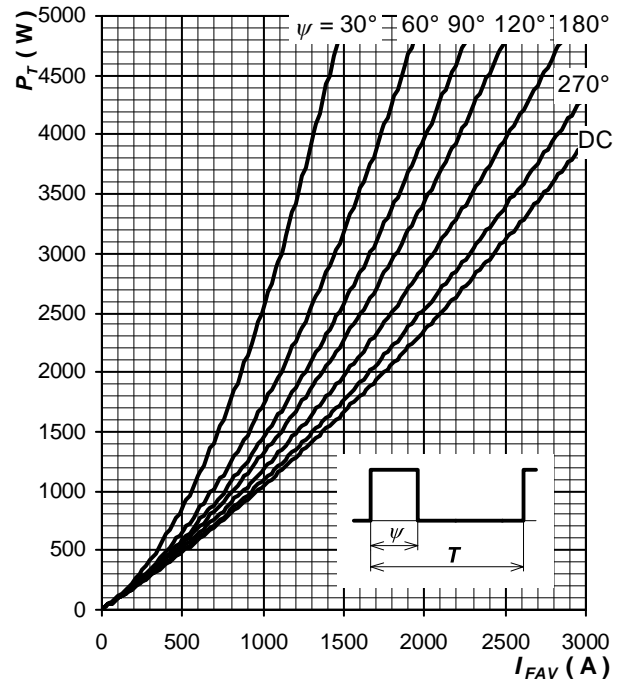

Fig. 7 Forward power loss vs. average forward current, square waveform, $f = 50 \text{ Hz}$, $T = 1/f$

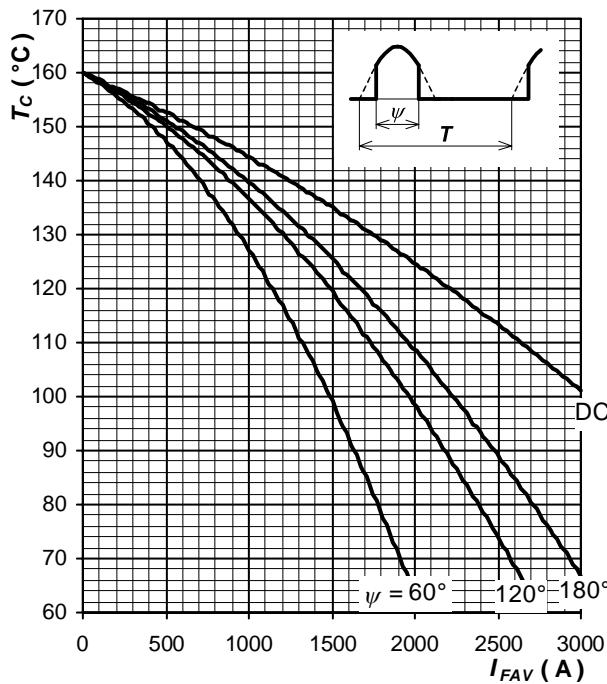

Fig. 8 Max. case temperature vs. aver. forward current, sine waveform, $f = 50 \text{ Hz}$, $T = 1/f$

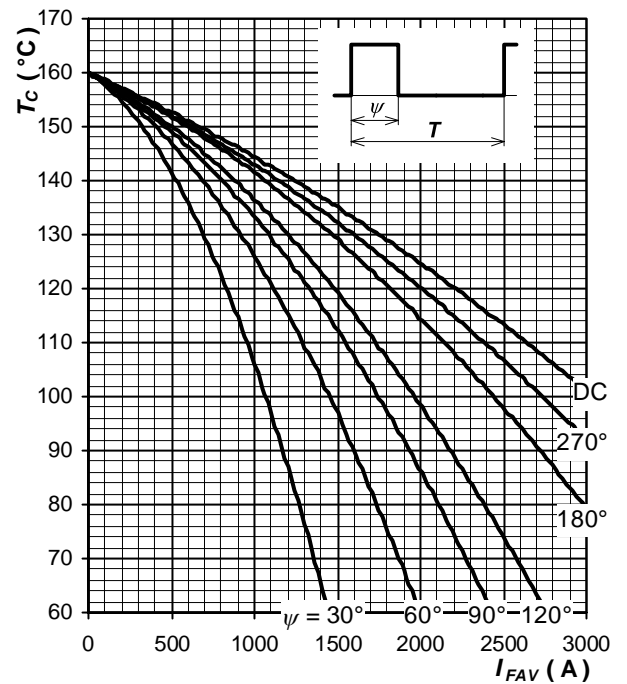

Fig. 9 Max. case temperature vs. aver. forward current, square waveform, $f = 50 \text{ Hz}$, $T = 1/f$

ABB s.r.o., Novodvorska 1768/138a, 142 21 Praha 4, Czech Republic

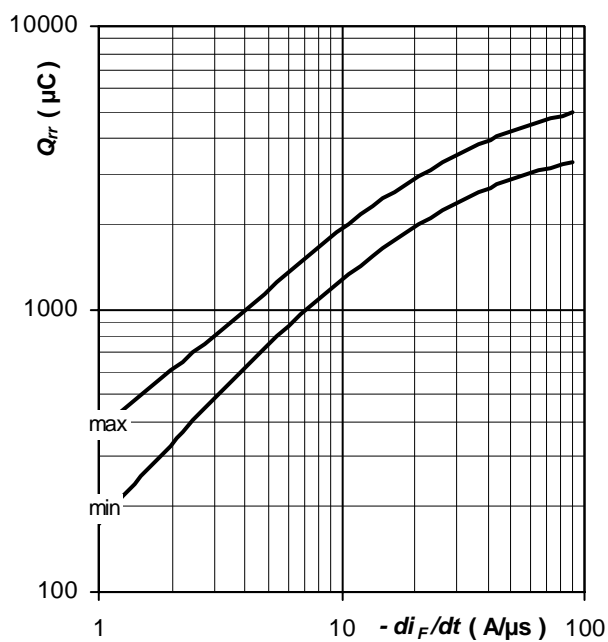

Fig. 10 Recovered charge Q_{rr}
vs. rate of fall forward current di_F/dt ,
trapezoid pulse, $I_{FM} = 1\,000\text{ A}$,
 $V_R = 100\text{ V}$, $T_j = T_{jmax}$

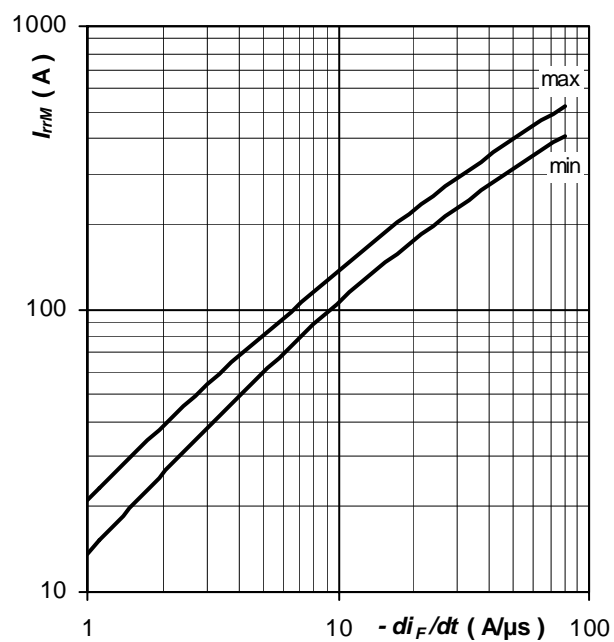

Fig. 11 Reverse recovery maximum current I_{rrM}
vs. rate of fall forward current di_F/dt ,
trapezoid pulse, $I_{FM} = 1\,000\text{ A}$,
 $V_R = 100\text{ V}$, $T_j = T_{jmax}$

Notes: