

V_{RRM}	=	4500 V
I_{FAVM}	=	900 A
I_{FSM}	=	16 kA
V_{F0}	=	1.8 V
r_F	=	0.9 m Ω
V_{DClink}	=	2400 V

Fast Recovery Diode

5SDF 07H4501

Doc. No. 5SYA 1111-02 Aug. 2000

- Patented free-floating silicon technology
- Low switching losses
- Optimized for use as large-area snubber diode in GTO converters
- Industry standard press-pack ceramic housing, hermetically plasma-welded
- Cosmic radiation withstand rating

Blocking

V_{RRM}	Repetitive peak reverse voltage	4500 V	Half sine wave, $t_p = 10$ ms, $f = 50$ Hz
I_{RRM}	Repetitive peak reverse current	≤ 200 mA	$V_R = V_{RRM}$, $T_j = 125^\circ\text{C}$
V_{DClink}	Permanent DC voltage for 100 FIT failure rate	2400 V	100% Duty
		2800 V	5% Duty
Ambient cosmic radiation at sea level in open air.			

Mechanical data (see Fig. 7)

F_m	Mounting force	min.	36 kN
		max.	44 kN
a	Acceleration:		
	Device unclamped		50 m/s ²
	Device clamped		200 m/s ²
m	Weight		0.83 kg
D_s	Surface creepage distance	\geq	30 mm
D_a	Air strike distance	\geq	20 mm

On-state (see Fig. 1, 2)

I_{FAVM}	Max. average on-state current	900 A	Half sine wave, $T_c = 85^\circ\text{C}$	
I_{FRMS}	Max. RMS on-state current	1400 A		
I_{FSM}	Max. peak non-repetitive surge current	16 kA	$t_p = 10 \text{ ms}$	Before surge: $T_c = T_j = 125^\circ\text{C}$
		40 kA	$t_p = 1 \text{ ms}$	
$\int I^2 dt$	Max. surge current integral	$1.28 \cdot 10^6 \text{ A}^2\text{s}$	$t_p = 10 \text{ ms}$	After surge: $V_R \approx 0 \text{ V}$
		$0.8 \cdot 10^6 \text{ A}^2\text{s}$	$t_p = 1 \text{ ms}$	
V_F	Forward voltage drop	$\leq 4.5 \text{ V}$	$I_F = 3000 \text{ A}$	$T_j = 125^\circ\text{C}$
V_{F0}	Threshold voltage	1.8 V	Approximation for	
r_F	Slope resistance	0.9 m Ω	$I_F = 500 \dots 5000 \text{ A}$	

Turn-on (see Fig. 3, 4)

V_{fr}	Peak forward recovery voltage	$\leq 55 \text{ V}$	$di/dt = 500 \text{ A}/\mu\text{s}$, $T_j = 125^\circ\text{C}$
----------	-------------------------------	---------------------	---

Turn-off

I_{rr}	Reverse recovery current	$\leq 260 \text{ A}$	
Q_{rr}	Reverse recovery charge	$\leq 1700 \mu\text{C}$	
E_{rr}	Turn-off energy	$\leq \text{J}$	

Thermal (see Fig. 8)

T_j	Operating junction temperature range	-40...125 $^\circ\text{C}$		
T_{stg}	Storage temperature range	-40...125 $^\circ\text{C}$		
R_{thJC}	Thermal resistance junction to case	$\leq 24 \text{ K/kW}$	Anode side cooled	$F_M = 36 \dots 44 \text{ kN}$
		$\leq 24 \text{ K/kW}$	Cathode side cooled	
		$\leq 12 \text{ K/kW}$	Double side cooled	
R_{thCH}	Thermal resistance case to heatsink	$\leq 6 \text{ K/kW}$	Single side cooled	
		$\leq 3 \text{ K/kW}$	Double side cooled	

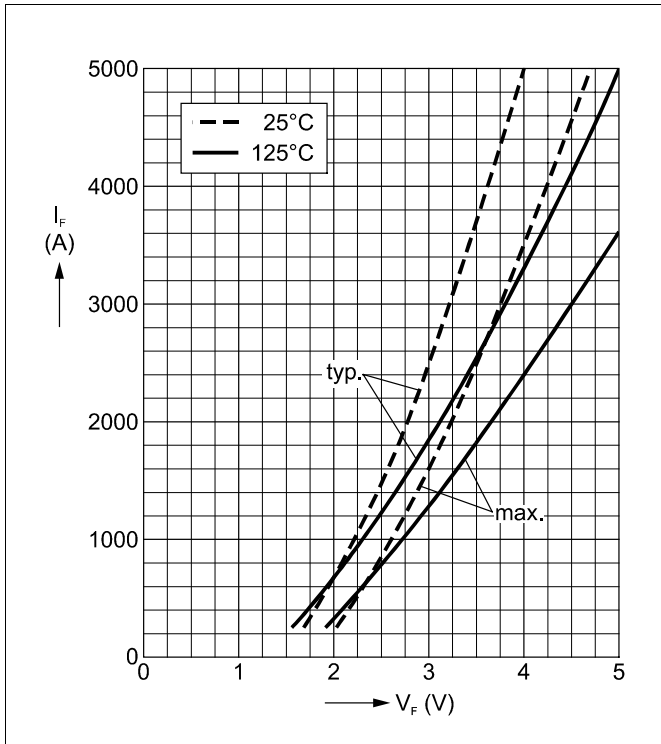

Fig. 1 Forward current vs. forward voltage (typ. and max. values) and linear approximation of max. curve at 125°C.

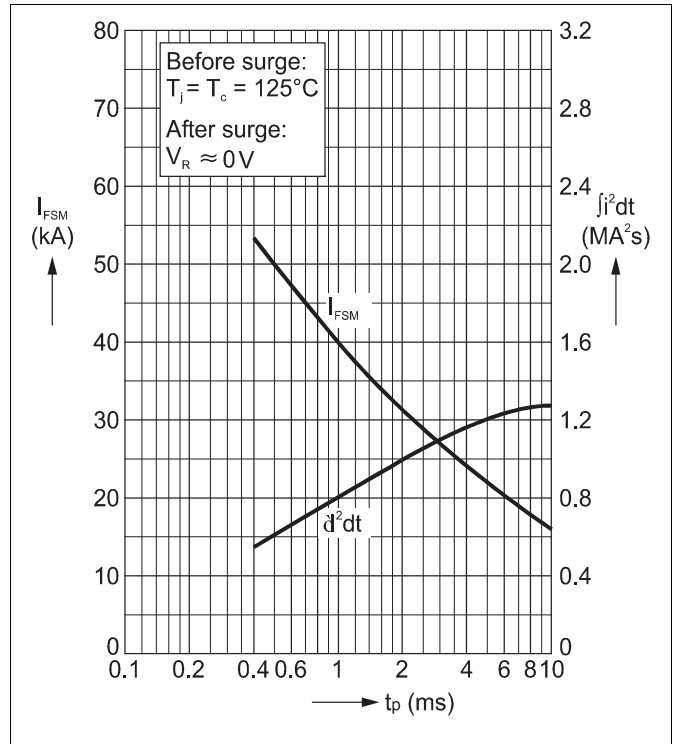

Fig. 2 Surge current and fusing integral vs. pulse width (max. values) for non-repetitive, half-sinusoidal surge current pulses.

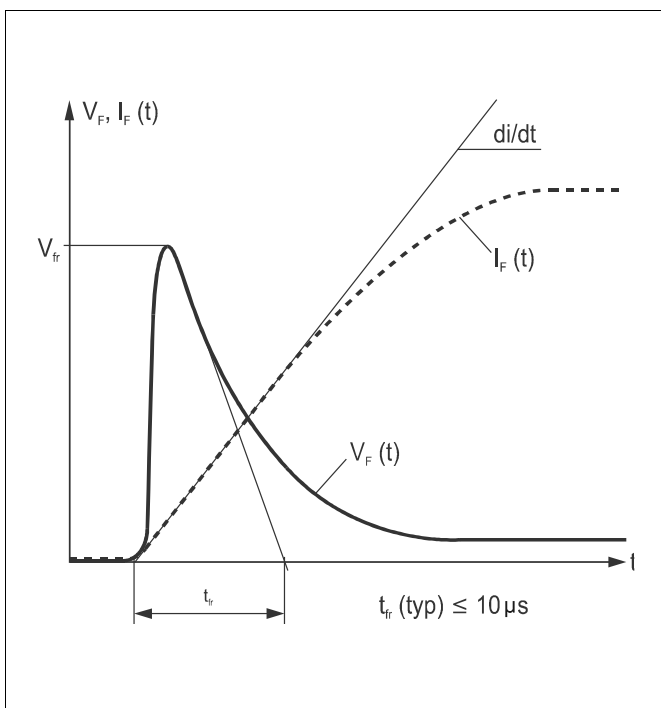

Fig. 3 Typical forward voltage waveform when the diode is turned on with a high di/dt .

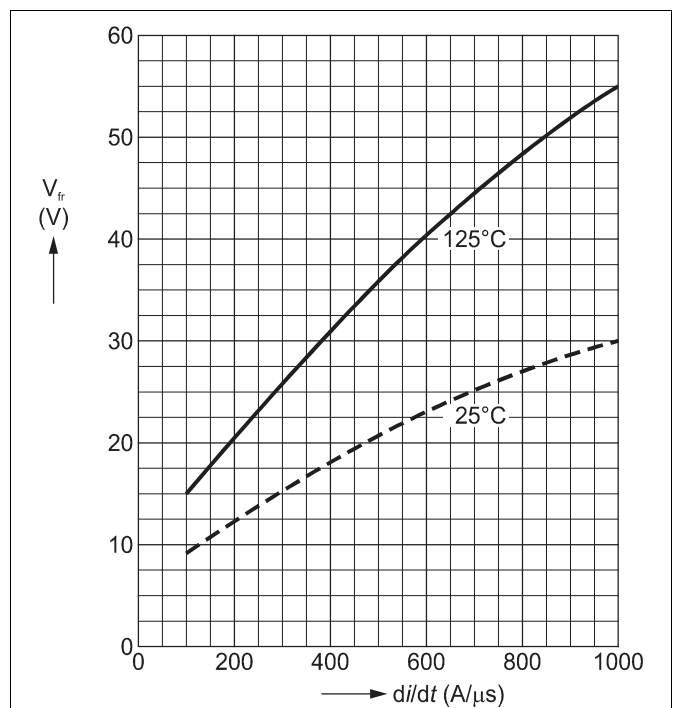

Fig. 4 Forward recovery voltage vs. turn-on di/dt (max. values).

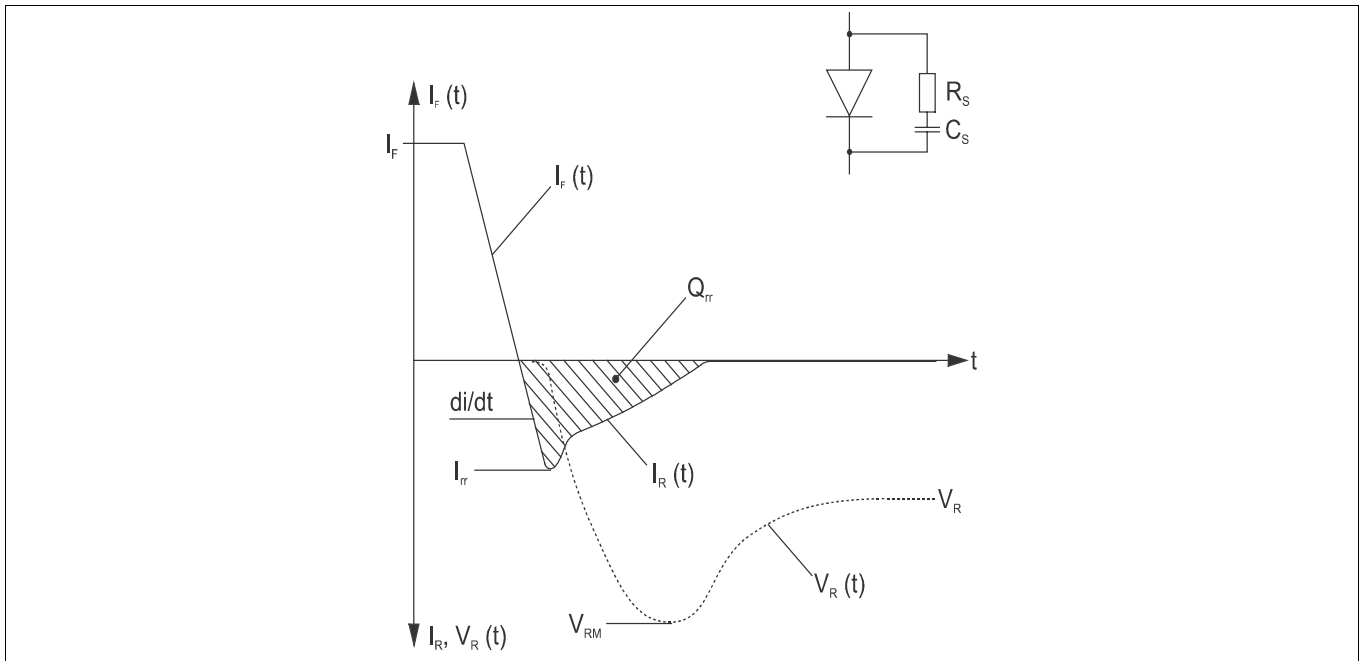

Fig. 5 Typical current and voltage waveforms at turn-off when the diode is connected to an RCD snubber, as often used in GTO circuits.

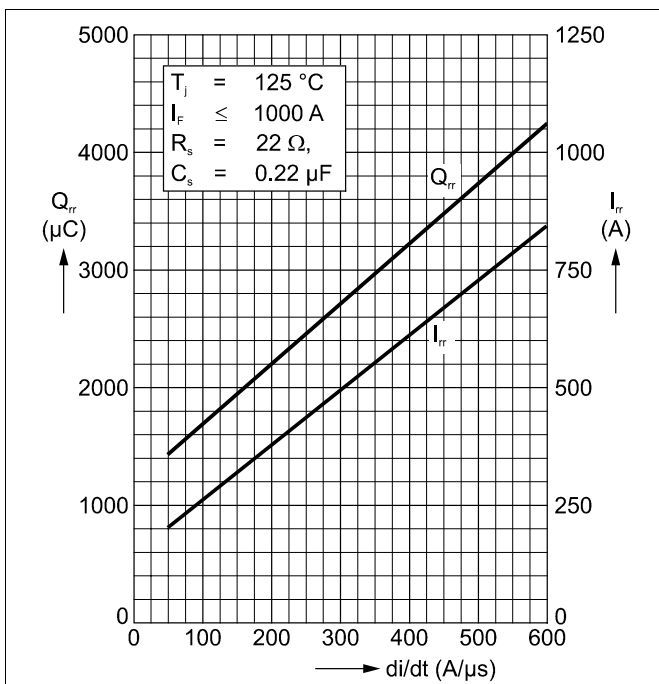

Fig. 6 Reverse recovery current vs. turn off di/dt (max. values).

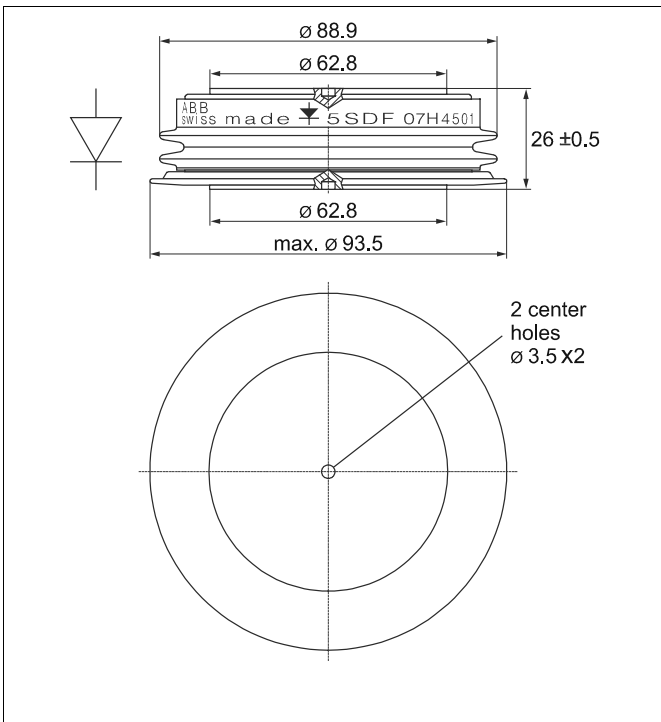

Fig. 7 Outline drawing. All dimensions are in millimeters and represent nominal values unless stated otherwise.

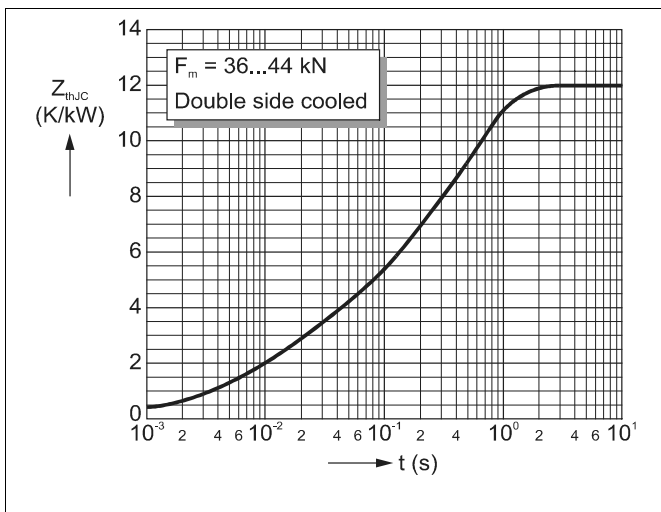

Fig. 8 Transient thermal impedance (junction-to-case) vs. time in analytical and graphical form (max. values).

$$Z_{thJC}(t) = \sum_{i=1}^4 R_i (1 - e^{-t/\tau_i})$$

i	1	2	3	4
R _i (K/kW)	7.44	2.00	1.84	0.71
τ _i (s)	0.47	0.091	0.011	0.0047

F_m = 36... 44 kN
 Double side cooled

ABB Semiconductors AG reserves the right to change specifications without notice.



ABB Semiconductors AG
 Fabrikstrasse 2
 CH-5600 Lenzburg, Switzerland

Doc. No. 5SYA 1111-02 Aug. 2000

Tel: +41 (0)62 888 6419
 Fax: +41 (0)62 888 6306
 E-mail: info@ch.abb.com
 Internet: www.abbsem.com