

V_{DRM}	=	5500 V
I_{TGQM}	=	900 A
I_{TSM}	=	7.5×10^3 A
$V_{\text{(T0)}}$	=	1.65 V
r_{T}	=	2 mW
$V_{\text{DC-link}}$	=	3300 V

Reverse Conducting Integrated Gate-Commutated Thyristor

5SHX 10H6010

PRELIMINARY

Doc. No. 5SYA1226-05 Aug 07

- High snubberless turn-off rating
- Optimized for medium frequency (<1 kHz) and low turn-off losses
- High reliability
- High electromagnetic immunity
- Simple control interface with status feedback
- AC or DC supply voltage
- Suitable for series connection (contact factory)

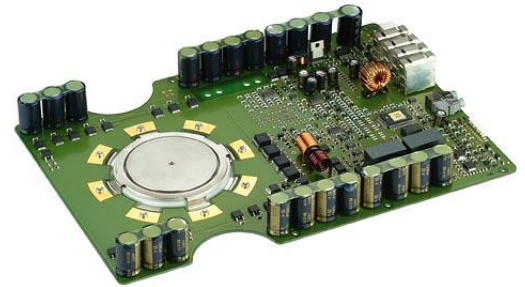

Blocking

Maximum rated values ^{Note 1}

Parameter	Symbol	Conditions	min	typ	max	Unit
Repetitive peak off-state voltage	V_{DRM}	Gate Unit energized			5500	V
Permanent DC voltage for 100 FIT failure rate of RC-GCT	$V_{\text{DC-link}}$	Ambient cosmic radiation at sea level in open air. Gate Unit energized			3300	V

Characteristic values

Parameter	Symbol	Conditions	min	typ	max	Unit
Repetitive peak off-state current	I_{DRM}	$V_{\text{D}} = V_{\text{DRM}}$, Gate Unit energized			20	mA

Mechanical data (see Fig. 20, 21)

Maximum rated values ^{Note 1}

Parameter	Symbol	Conditions	min	typ	max	Unit
Mounting force	F_{m}		18	20	22	kN

Characteristic values

Parameter	Symbol	Conditions	min	typ	max	Unit
Pole-piece diameter	D_{p}	± 0.1 mm		63		mm
Housing thickness	H		26.0		26.5	mm
Weight	m				1.7	kg
Surface creepage distance	D_{s}	Anode to Gate	33			mm
Air strike distance	D_{a}	Anode to Gate	13			mm
Length	l	± 1.0 mm		296		mm
Height	h	± 1.0 mm		48		mm
Width IGCT	w	± 1.0 mm		208		mm

Note 1 Maximum rated values indicate limits beyond which damage to the device may occur

ABB Switzerland Ltd, Semiconductors reserves the right to change specifications without notice.



GCT Data

On-state (see Fig. 3 to 6, 23)

Maximum rated values Note 1

Parameter	Symbol	Conditions	min	typ	max	Unit
Max. average on-state current	$I_{T(AV)M}$	Half sine wave, $T_C = 85\text{ °C}$, Double side cooled			350	A
Max. RMS on-state current	$I_{T(RMS)}$				560	A
Max. peak non-repetitive surge on-state current	I_{TSM}	$t_p = 10\text{ ms}$, $T_j = 115\text{ °C}$, sine wave after surge: $V_D = V_R = 0\text{ V}$			7.5×10^3	A
Limiting load integral	I^2t				281×10^3	A^2s
Max. peak non-repetitive surge on-state current	I_{TSM}	$t_p = 1\text{ ms}$, $T_j = 115\text{ °C}$, sine wave after surge: $V_D = V_R = 0\text{ V}$			15×10^3	A
Limiting load integral	I^2t				112×10^3	A^2s
Critical rate of rise of on-state current	di_T/dt_{cr}	For higher di_T/dt and current lower than 50 A an external retrigger pulse is required.			TBD	A/ μs

Characteristic values

Parameter	Symbol	Conditions	min	typ	max	Unit
On-state voltage	V_T	$I_T = 900\text{ A}$, $T_j = 115\text{ °C}$			3.45	V
Threshold voltage	$V_{(T0)}$	$T_j = 115\text{ °C}$ $I_T = 200 \dots 2000\text{ A}$			1.65	V
Slope resistance	r_T				2	$m\Omega$

Turn-on switching (see Fig. 23, 25)

Maximum rated values Note 1

Parameter	Symbol	Conditions	min	typ	max	Unit
Critical rate of rise of on-state current	di_T/dt_{cr}	$f = 500\text{ Hz}$, $T_j = 115\text{ °C}$, $I_T = 900\text{ A}$, $V_D = 3300\text{ V}$			285	A/ μs

Characteristic values

Parameter	Symbol	Conditions	min	typ	max	Unit
Turn-on delay time	t_{don}	$V_D = 3300\text{ V}$, $T_j = 115\text{ °C}$ $I_T = 900\text{ A}$, $di/dt = V_D / L_i$ $L_i = 11.5\text{ }\mu H$ $C_{CL} = 2\text{ }\mu F$, $L_{CL} = 0.6\text{ }\mu H$			3	μs
Turn-on delay time status feedback	$t_{don SF}$				7	μs
Rise time	t_r				1	μs
Turn-on energy per pulse	E_{on}				0.5	J

Turn-off switching (see Fig. 7, 8, 23, 25)

Maximum rated values Note 1

Parameter	Symbol	Conditions	min	typ	max	Unit
Max. controllable turn-off current	I_{TGQM}	$V_{DM} \leq V_{DRM}$, $T_j = 115\text{ °C}$, $V_D = 3300\text{ V}$, $R_S = 1.25\text{ }\Omega$, $C_{CL} = 2\text{ }\mu F$, $L_{CL} \leq 0.6\text{ }\mu H$			900	A
Max. controllable turn-off current	I_{TGQM}	$V_{DM} \leq V_{DRM}$, $T_j = 115\text{ °C}$, $V_D = 3900\text{ V}$, $R_S = 1.25\text{ }\Omega$, $C_{CL} = 2\text{ }\mu F$, $L_{CL} \leq 0.6\text{ }\mu H$			460	A

Characteristic values

Parameter	Symbol	Conditions	min	typ	max	Unit
Turn-off delay time	t_{doff}	$V_D = 3300\text{ V}$, $T_j = 115\text{ °C}$ $V_{DM} \leq V_{DRM}$, $R_S = 1.25\text{ }\Omega$ $I_{TGQ} = 900\text{ A}$, $L_i = 11.5\text{ }\mu H$ $C_{CL} = 2\text{ }\mu F$, $L_{CL} = 0.6\text{ }\mu H$			6	μs
Turn-off delay time status feedback	$t_{doff SF}$				7	μs
Turn-off energy per pulse	E_{off}				4.8	J

Diode Data

On-state (see Fig. 9 to 12, 24, 25)

Maximum rated values ^{Note 1}

Parameter	Symbol	Conditions	min	typ	max	Unit
Max. average on-state current	$I_{F(AV)M}$	Half sine wave, $T_C = 85\text{ °C}$			170	A
Max. RMS on-state current	$I_{F(RMS)}$				260	A
Max. peak non-repetitive surge current	I_{FSM}	$t_p = 10\text{ ms}$, $T_{vj} = 115\text{ °C}$, $V_R = 0\text{ V}$			7.6×10^3	A
Limiting load integral	I^2t				288.8×10^3	A^2s
Max. peak non-repetitive surge current	I_{FSM}	$t_p = 1\text{ ms}$, $T_{vj} = 115\text{ °C}$, $V_R = 0\text{ V}$			17.5×10^3	A
Limiting load integral	I^2t				153×10^3	A^2s

Characteristic values

Parameter	Symbol	Conditions	min	typ	max	Unit
On-state voltage	V_F	$I_F = 900\text{ A}$, $T_{vj} = 115\text{ °C}$			6.4	V
Threshold voltage	$V_{(F0)}$	$T_{vj} = 115\text{ °C}$			2.53	V
Slope resistance	r_F	$I_F = 200\text{...}2000\text{ A}$			4.3	$m\Omega$

Turn-on (see Fig. 24, 25)

Characteristic values

Parameter	Symbol	Conditions	min	typ	max	Unit
Peak forward recovery voltage	V_{FRM}	$di_F/dt = 350\text{ A}/\mu\text{s}$, $T_{vj} = 115\text{ °C}$			80	V
		$di_F/dt = 1600\text{ A}/\mu\text{s}$, $T_{vj} = 115\text{ °C}$			250	V

Turn-off (see Fig. 13 to 17, 24, 25)

Maximum rated values ^{Note 1}

Parameter	Symbol	Conditions	min	typ	max	Unit
Max. decay rate of on-state current	di/dt_{crit}	$I_{FM} = 900\text{ A}$, $T_{vj} = 115\text{ °C}$ $V_{DClink} = 3900\text{ V}$			285	$A/\mu\text{s}$

Characteristic values

Parameter	Symbol	Conditions	min	typ	max	Unit
Reverse recovery current	I_{RM}	$I_{FM} = 900\text{ A}$, $V_{DC-Link} = 3300\text{ V}$			430	A
Reverse recovery charge	Q_{rr}	$-di_F/dt = 285\text{ A}/\mu\text{s}$, $L_{CL} = 0.6\text{ }\mu\text{H}$ $C_{CL} = 2\text{ }\mu\text{F}$, $R_S = 1.25\text{ }\Omega$,			TBD	μC
Turn-off energy	E_{rr}	$T_{vj} = 115\text{ °C}$, $D_{CL} = 5\text{SDF 02D6004}$			2.6	J

Gate Unit Data

Power supply (see Fig. 18, 19)

Maximum rated values ^{Note 1}

Parameter	Symbol	Conditions	min	typ	max	Unit
Gate Unit voltage (Connector X1)	$V_{GIN,RMS}$	AC square wave amplitude (15 kHz - 100kHz) or DC voltage. No galvanic isolation to power circuit.	28		40	V
Min. current needed to power up the Gate Unit	$I_{GIN Min}$	Rectified average current see application note 5SYA 2031	1.1			A
Gate Unit power consumption	$P_{GIN Max}$				80	W

Characteristic values

Parameter	Symbol	Conditions	min	typ	max	Unit
Internal current limitation	$I_{GIN Max}$	Rectified average current limited by the Gate Unit			7	A

Optical control input/output ²⁾ (see Fig. 23)

Maximum rated values ^{Note 1}

Parameter	Symbol	Conditions	min	typ	max	Unit
Min. on-time	t_{on}		40			μs
Min. off-time	t_{off}		40			μs

Characteristic values

Parameter	Symbol	Conditions	min	typ	max	Unit	
Optical input power	$P_{on CS}$	CS: Command signal SF: Status feedback Valid for 1mm plastic optical fiber (POF)	-15		-1	dBm	
Optical noise power	$P_{off CS}$				-45	dBm	
Optical output power	$P_{on SF}$			-19		-1	dBm
Optical noise power	$P_{off SF}$					-50	dBm
Pulse width threshold	t_{GLITCH}	Max. pulse width without response			400	ns	
External retrigger pulse width	t_{retrig}		600		1100	ns	

2) Do not disconnect or connect fiber optic cables while light is on.

Connectors ²⁾ (see Fig. 20 to 22)

Parameter	Symbol	Description
Gate Unit power connector	X1	AMP: MTA-156, Part Number 641210-5 ³⁾
LWL receiver for command signal	CS	Avago, Type HFBR-2528 ⁴⁾
LWL transmitter for status feedback	SF	Avago, Type HFBR-1528 ⁴⁾

2) Do not disconnect or connect fiber optic cables while light is on.

3) AMP, www.amp.com

4) Avago Technologies, www.avagotech.com

Visual feedback (see Fig. 22)

Parameter	Symbol	Description	Color
Gate OFF	LED1	"Light" when GCT is off	(green)
Gate ON	LED2	"Light" when gate-current is flowing	(yellow)
Fault	LED3	"Light" when not ready / Failure	(red)
Power supply voltage OK	LED4	"Light" when power supply is within specified range	(green)

Thermal

Maximum rated values ^{Note 1}

Parameter	Symbol	Conditions	min	typ	max	Unit
Junction operating temperature	T _{vj}		0		115	°C
Storage temperature range	T _{stg}		-40		60	°C
Ambient operational temperature	T _a		0		60	°C

Characteristic values

Parameter	Symbol	Conditions	min	typ	max	Unit
Thermal resistance junction-to-case of GCT	R _{th(jc)}	Double side cooled			25	K/kW
Thermal resistance case-to-heatsink of GCT	R _{th(ch)}	Diode not dissipating			8	K/kW
Thermal resistance junction-to-case of Diode	R _{th(jc)}	Double side cooled			42	K/kW
Thermal resistance case-to-heatsink of Diode	R _{th(ch)}	GCT not dissipating			8	K/kW

Analytical function for transient thermal impedance:

$$Z_{thJC}(t) = \sum_{i=1}^n R_i(1 - e^{-t/\tau_i})$$

GCT

i	1	2	3	4
R _i (K/kW)	15.295	5.736	2.684	1.289
τ _i (s)	0.4820	0.0758	0.0076	0.0023

Diode

i	1	2	3	4
R _i (K/kW)	25.199	9.964	4.491	2.347
τ _i (s)	0.4963	0.0802	0.0076	0.0023

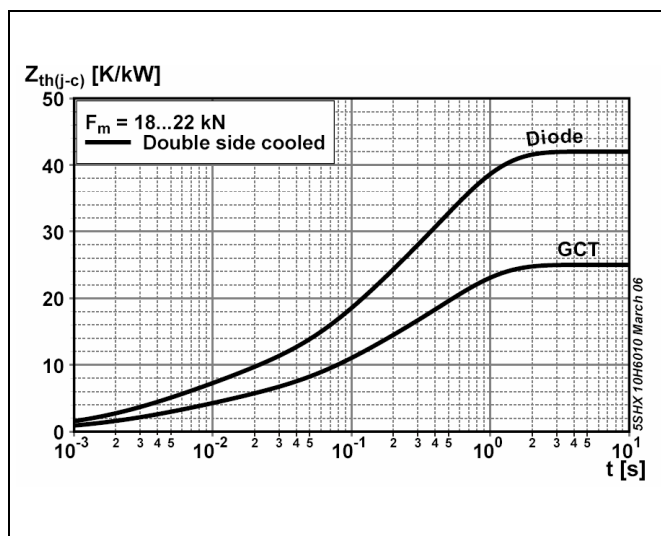

Fig. 1 Transient thermal impedance (junction-to-case) vs. time (max. values)

Max. Turn-off current for Lifetime operation

- calculated lifetime of on-board capacitors 20 years
- with slightly forced air cooling (air velocity > 0.5 m/s)
- strong air cooling allows for increased ambient temperature

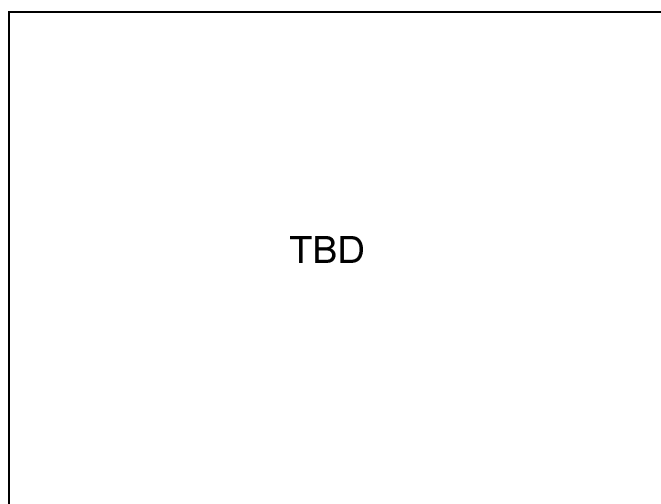

Fig. 2 Max. turn-off current vs. frequency for lifetime operation

GCT Part

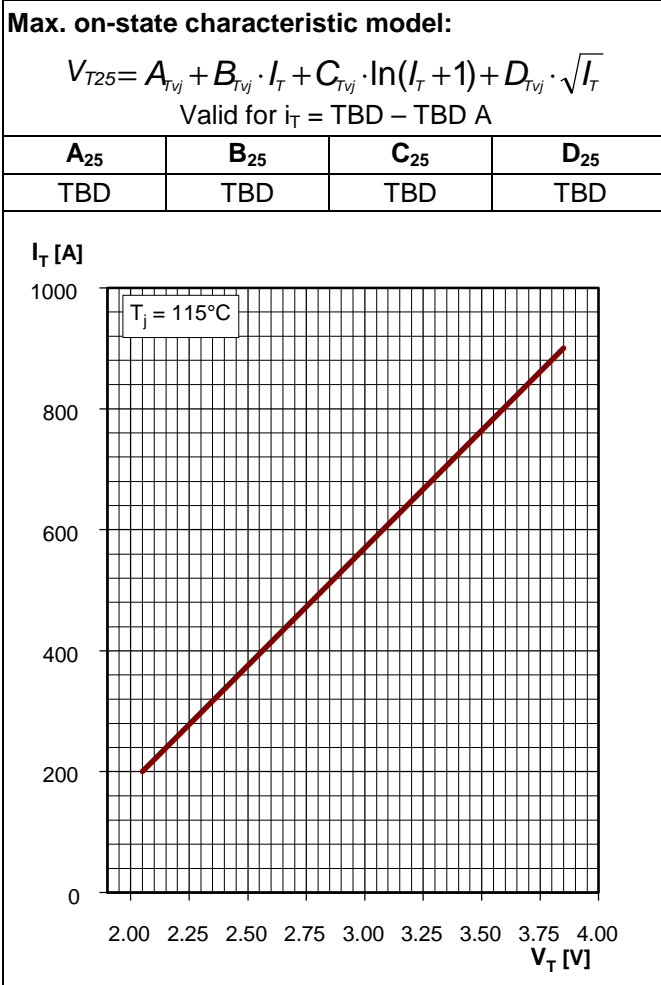

Fig. 3 GCT on-state voltage characteristics

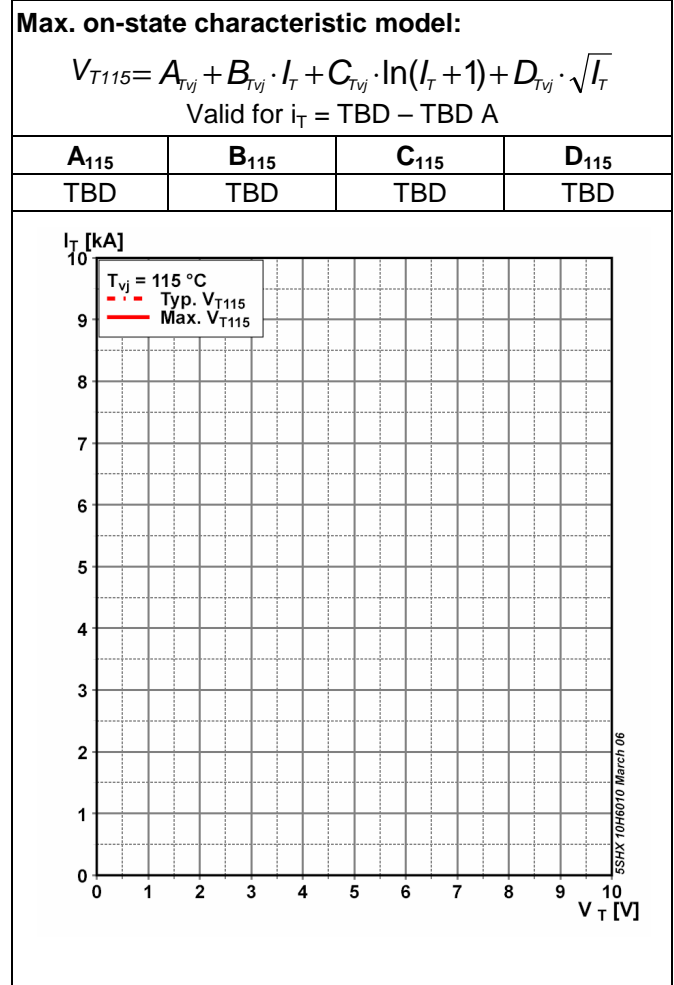

Fig. 4 GCT on-state voltage characteristics

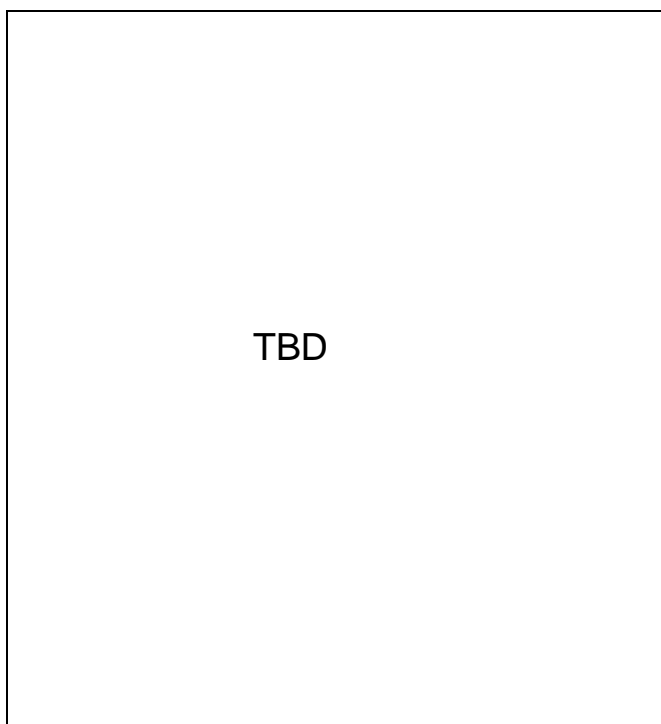

Fig. 5 GCT surge on-state current vs. pulse length, half-sine wave

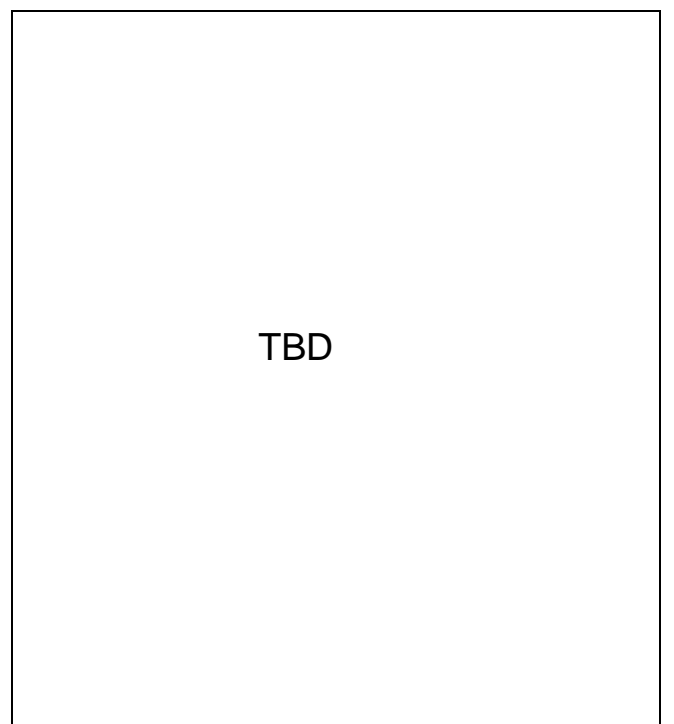

Fig. 6 GCT surge on-state current vs. number of pulses, half-sine wave, 10 ms, 50Hz

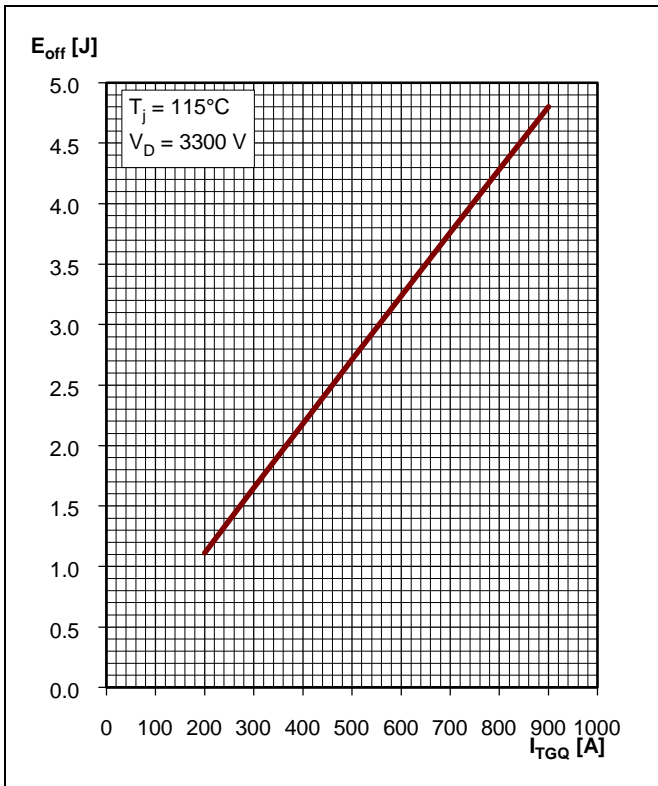

Fig. 7 GCT turn-off energy per pulse vs. turn-off current

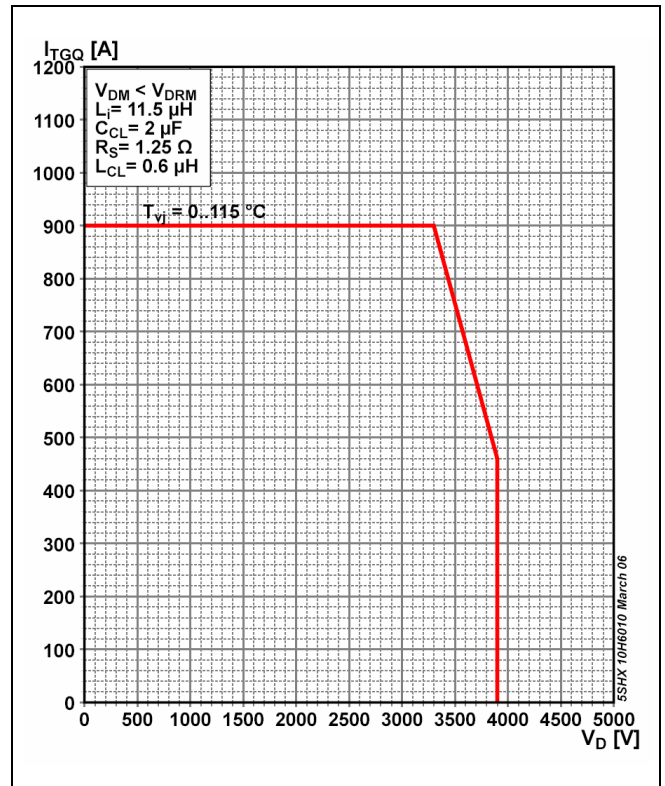

Fig. 8 GCT Safe Operating Area

Diode Part

Max. on-state characteristic model:

$$V_{F25} = A_{Tvj} + B_{Tvj} \cdot I_T + C_{Tvj} \cdot \ln(I_T + 1) + D_{Tvj} \cdot \sqrt{I_T}$$

Valid for $I_F = \text{TBD} - \text{TBD A}$

A ₂₅	B ₂₅	C ₂₅	D ₂₅
TBD	TBD	TBD	TBD

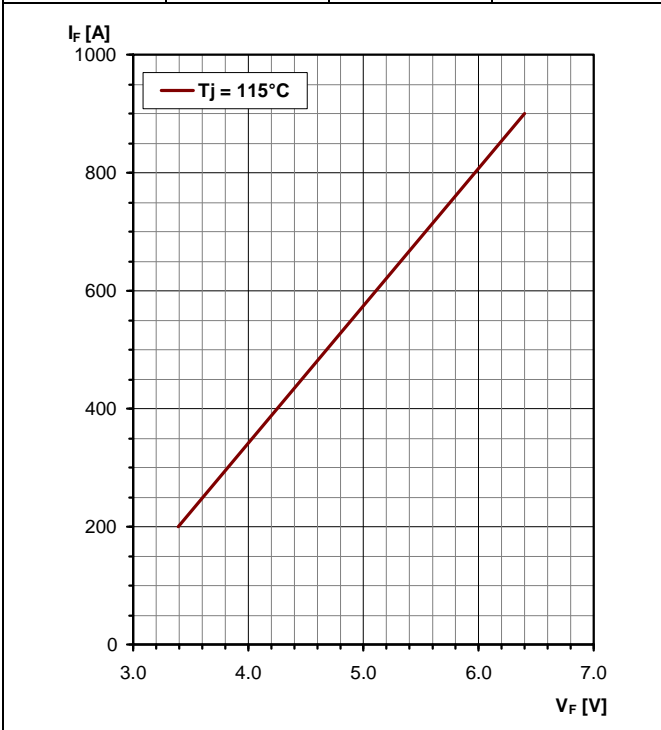

Fig. 9 Diode on-state voltage characteristics

Max. on-state characteristic model:

$$V_{F115} = A_{Tvj} + B_{Tvj} \cdot I_T + C_{Tvj} \cdot \ln(I_T + 1) + D_{Tvj} \cdot \sqrt{I_T}$$

Valid for $I_T = \text{TBD} - \text{TBD A}$

A ₁₁₅	B ₁₁₅	C ₁₁₅	D ₁₁₅
TBD	TBD	TBD	TBD

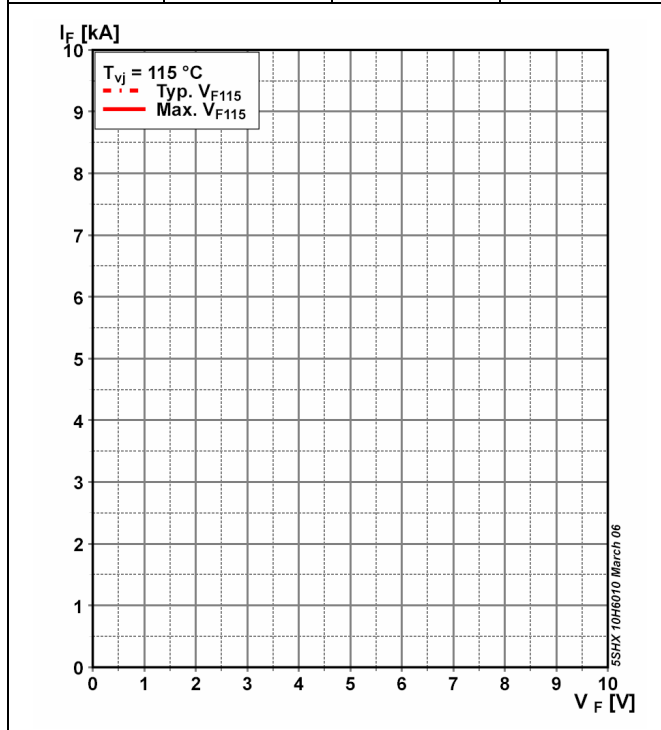

Fig. 10 Diode on-state voltage characteristics

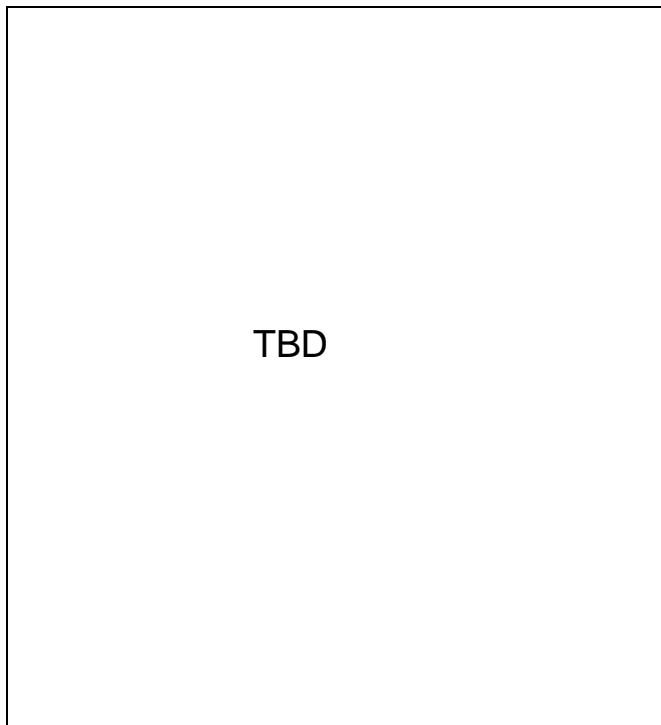

Fig. 11 Diode surge on-state current vs. pulse length, half-sine wave

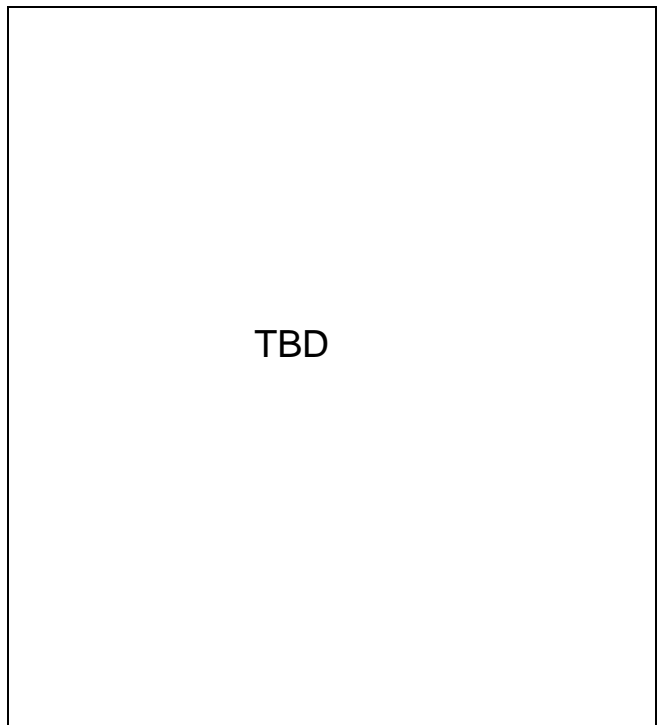

Fig. 12 Diode surge on-state current vs. number of pulses, half-sine wave, 10 ms, 50Hz

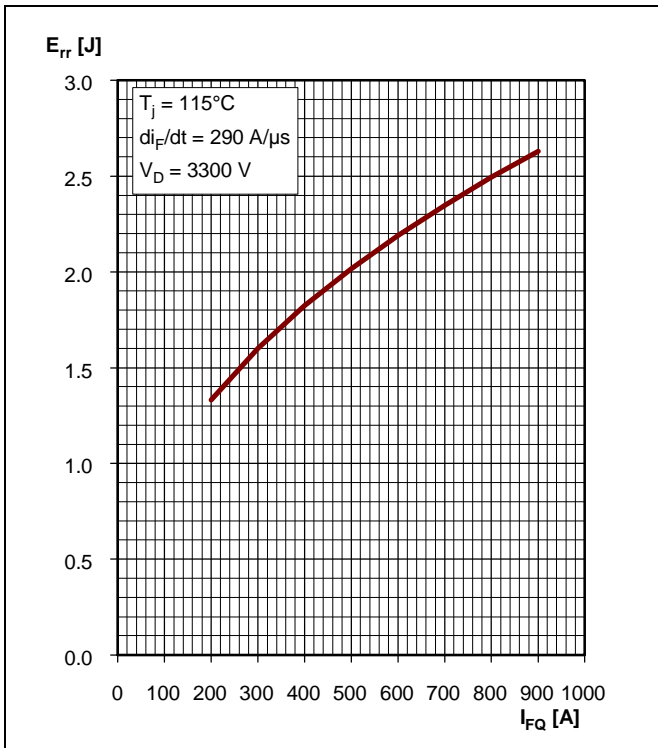

Fig. 13 Upper scatter range of diode turn-off energy per pulse vs. turn-off current

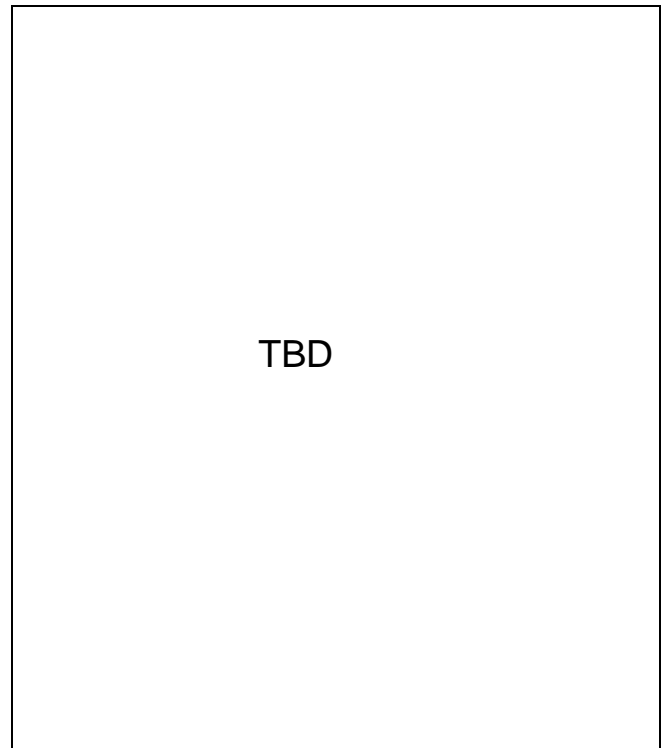

Fig. 14 Upper scatter range of diode turn-off energy per pulse vs decay rate of on-state current

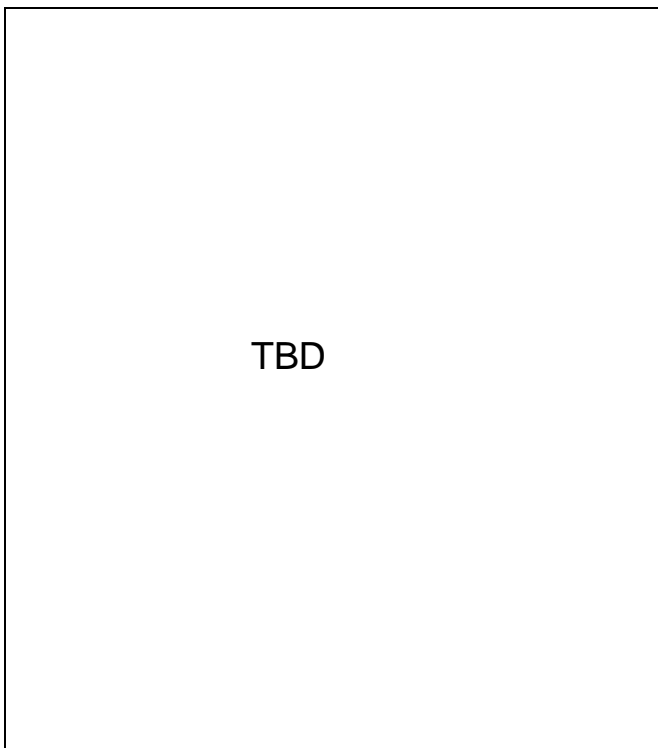

Fig. 15 Upper scatter range of diode reverse recovery charge vs decay rate of on-state current

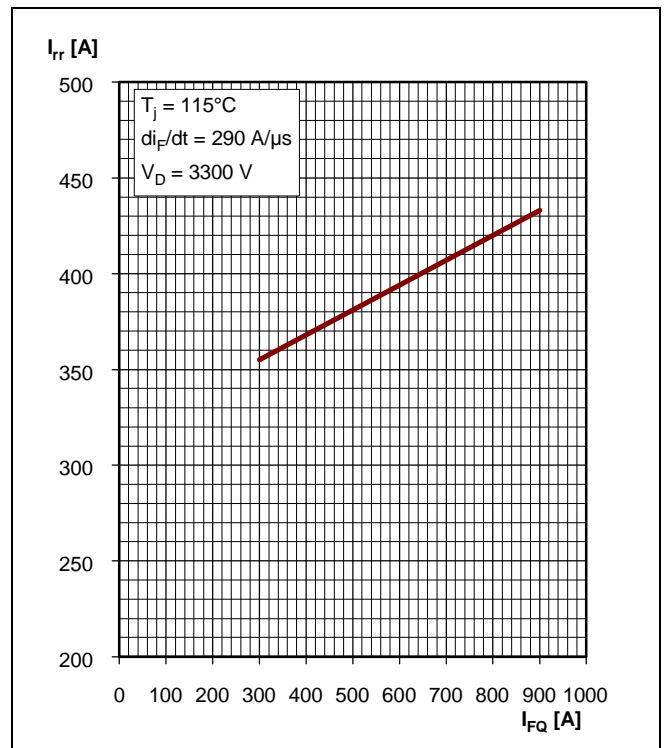

Fig. 16 Upper scatter range of diode reverse recovery current vs decay rate of on-state current

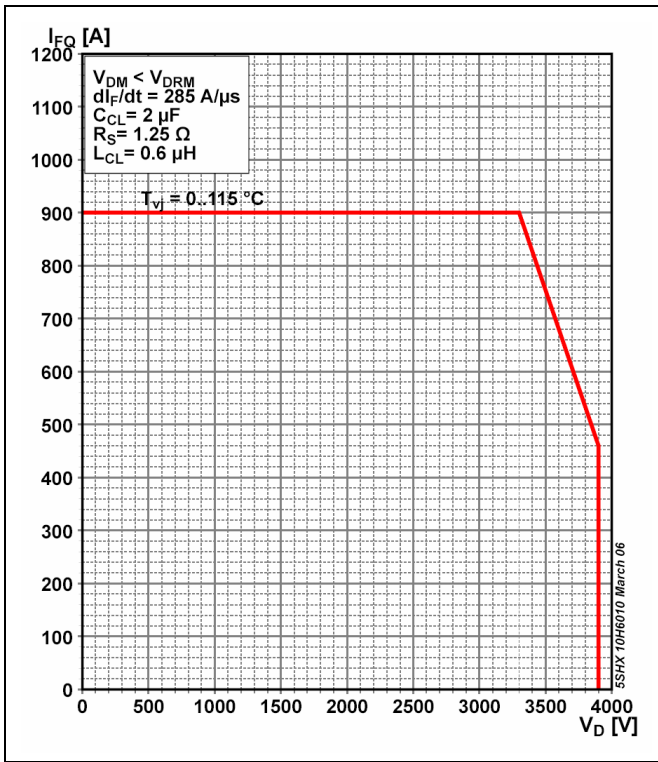

Fig. 17 Diode Safe Operating Area

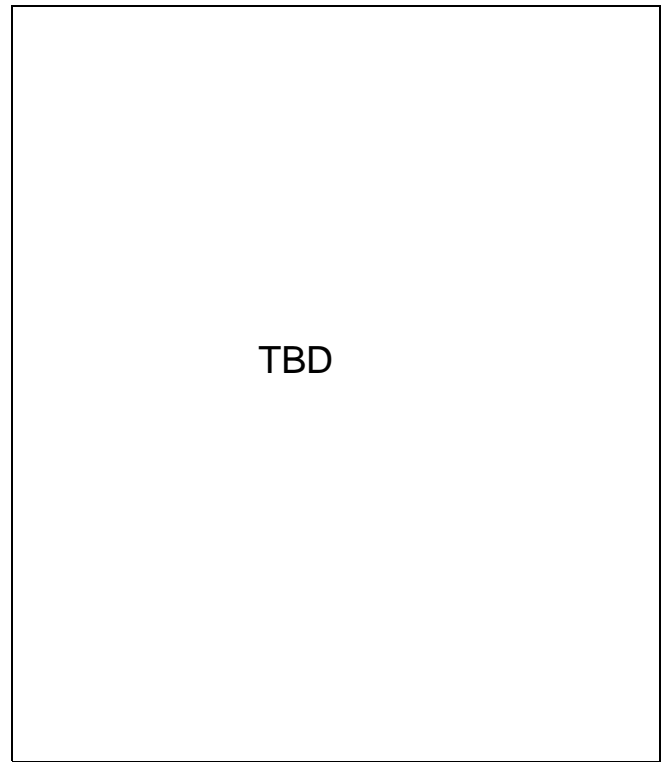

Fig. 18 Max. Gate Unit input power in chopper mode

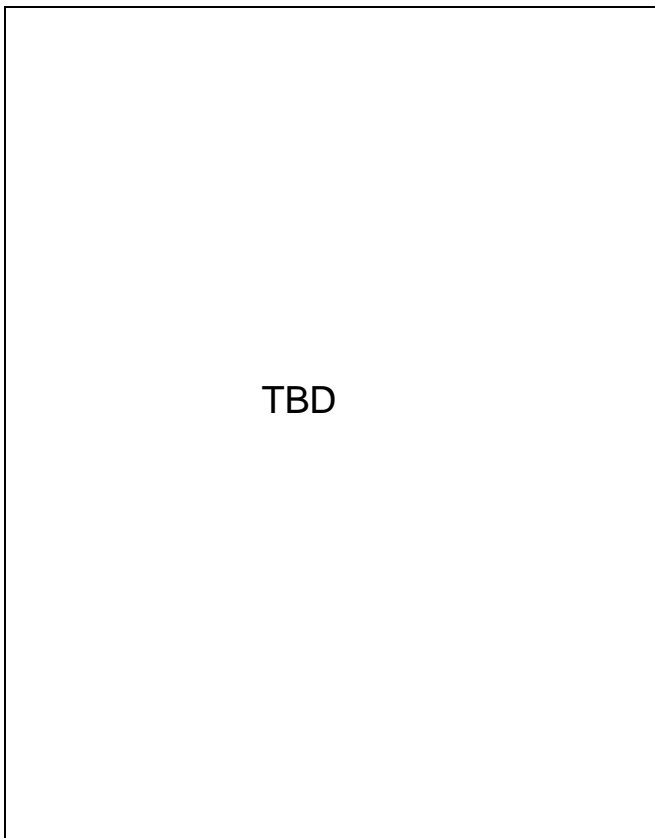

Fig. 19 Burst capability of Gate Unit

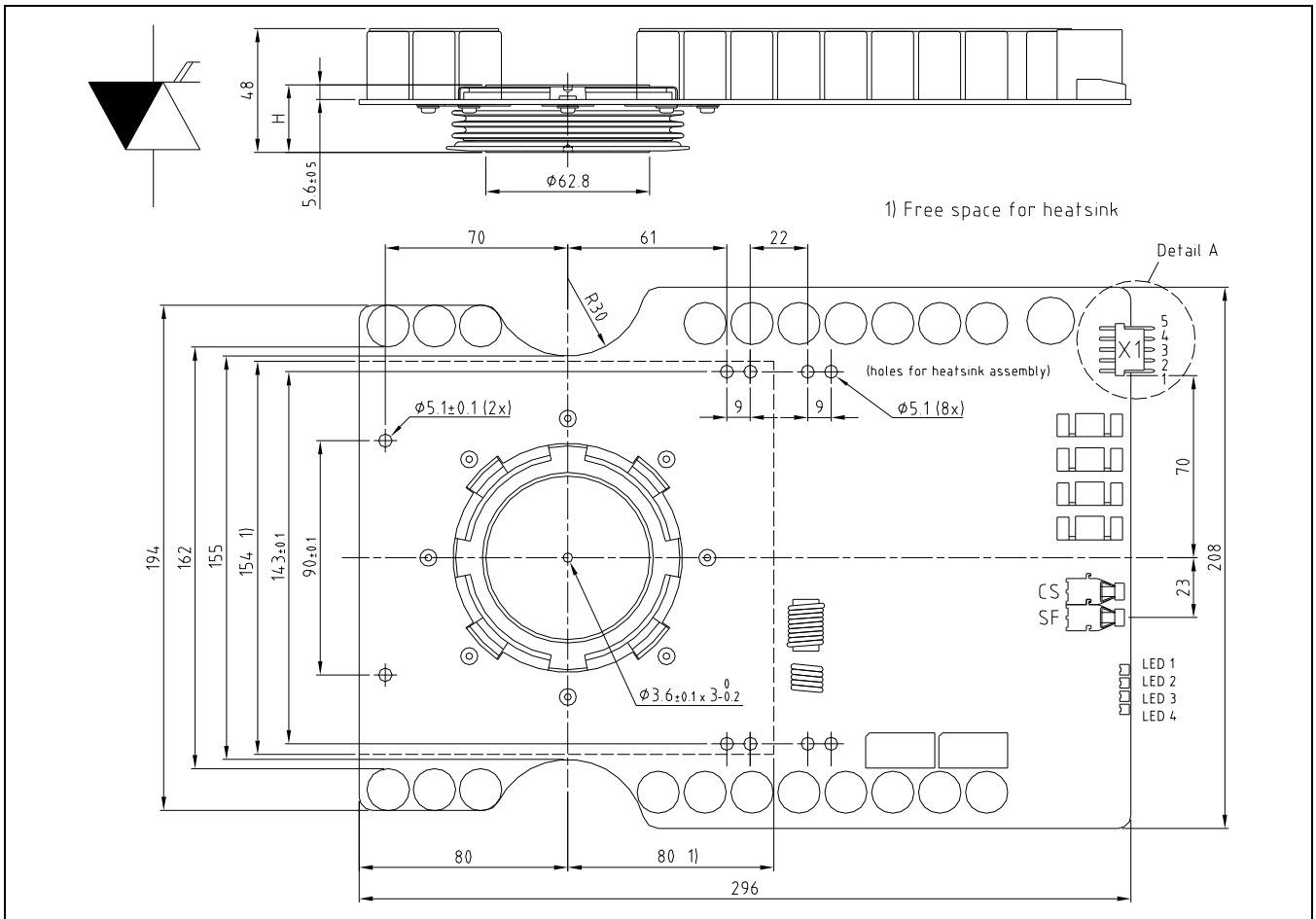

Fig. 20 Outline drawing; all dimensions are in millimeters and represent nominal values unless stated otherwise

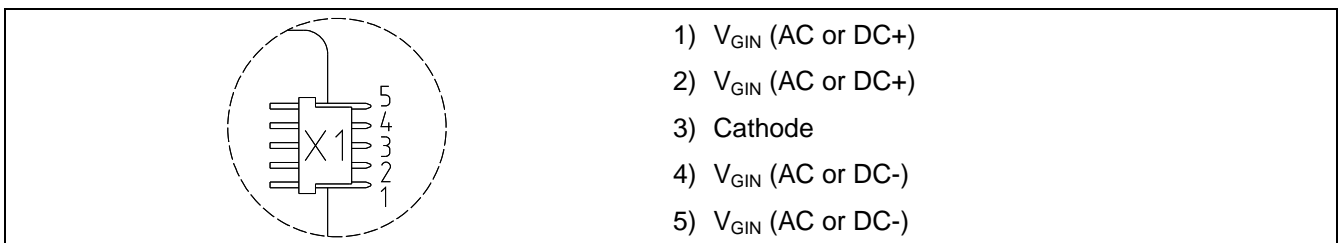

Fig. 21 Detail A: pin out of supply connector X1.

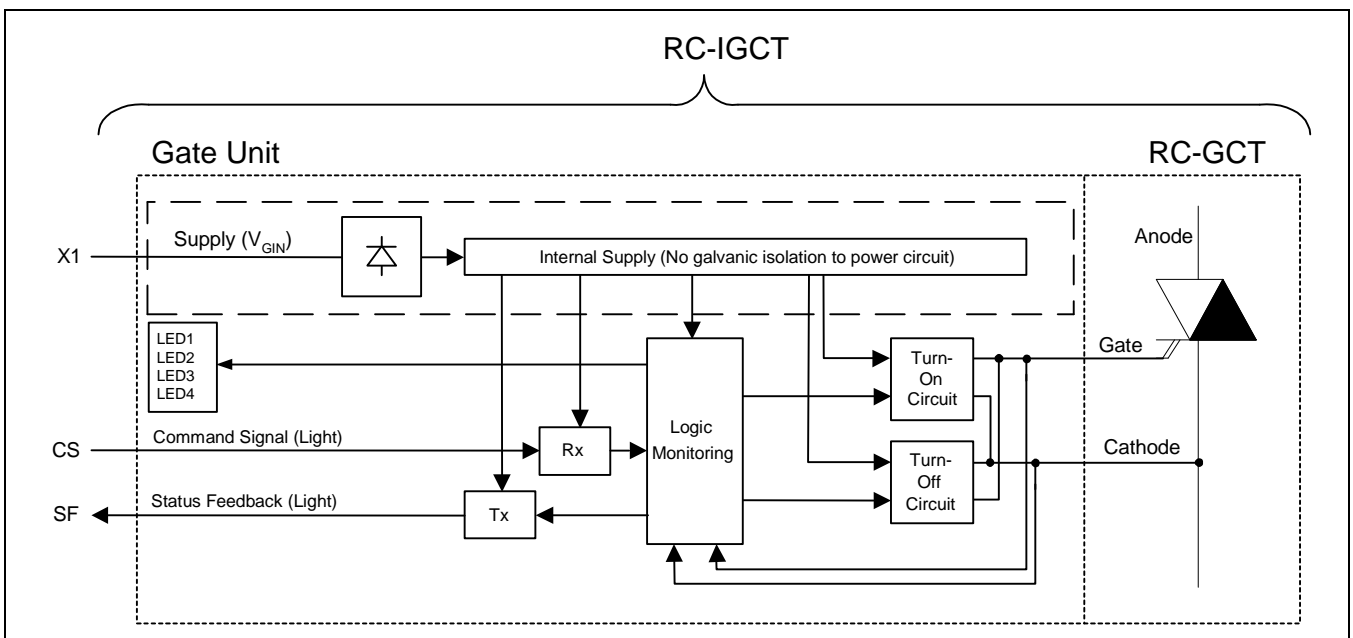

Fig. 22 Block diagram

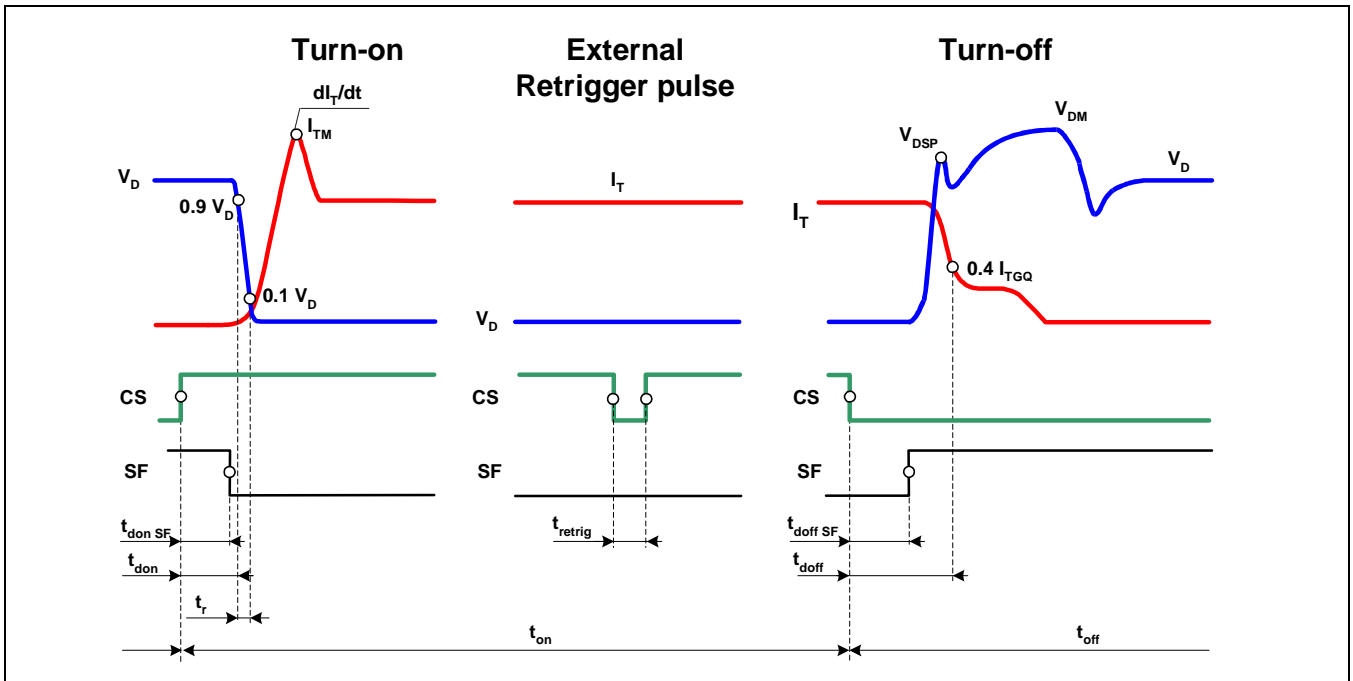

Fig. 23 General current and voltage waveforms with IGCT-specific symbols

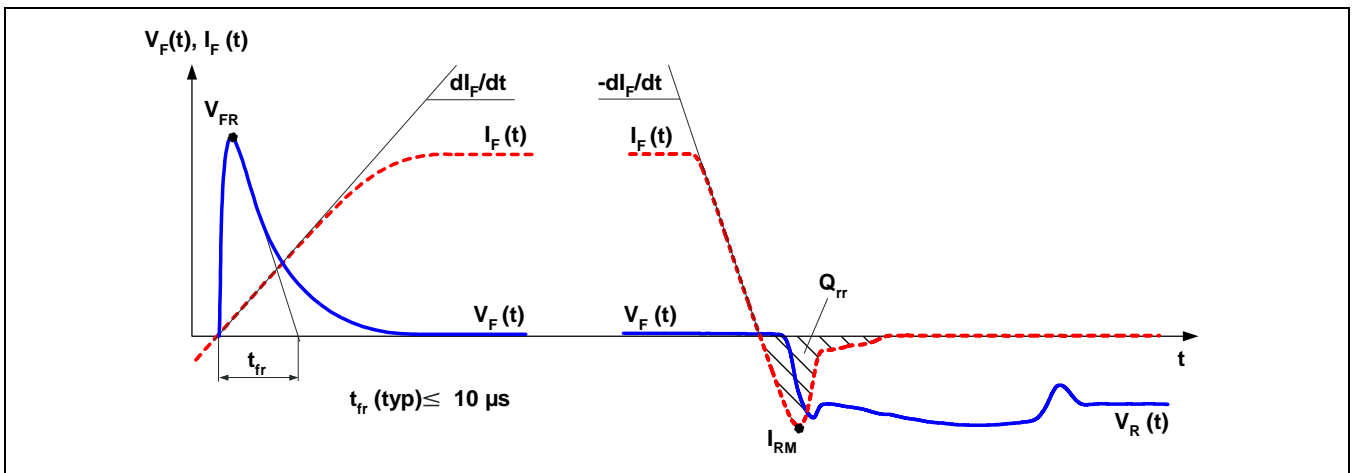

Fig. 24 General current and voltage waveforms with Diode-specific symbols

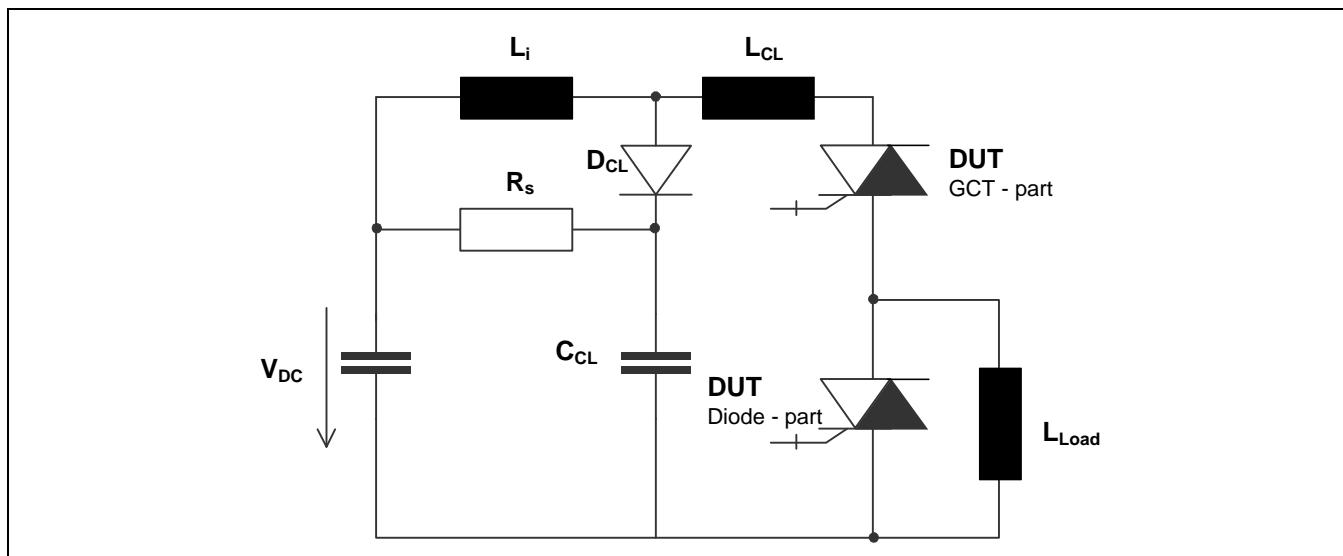

Fig. 25 Test circuit

Related documents:

5SYA 2031	Applying IGCT Gate Units
5SYA 2032	Applying IGCTs
5SYA 2036	Recommendations regarding mechanical clamping of Press Pack High Power Semiconductors
5SYA 2046	Failure rates of IGCTs due to cosmic rays
5SYA 2048	Field measurements on High Power Press Pack Semiconductors
5SYA 2051	Voltage ratings of high power semiconductors
5SZK 9107	Specification of environmental class for pressure contact IGCTs, OPERATION available on request, please contact factory

Please refer to <http://www.abb.com/semiconductors> for current version of documents.

ABB Switzerland Ltd, Semiconductors reserves the right to change specifications without notice.

ABB

ABB Switzerland Ltd
Semiconductors
 Fabrikstrasse 3
 CH-5600 Lenzburg, Switzerland

Doc. No. 5SYA1226-05 Aug 07

Telephone +41 (0)58 586 1419
 Fax +41 (0)58 586 1306
 Email abbsem@ch.abb.com
 Internet www.abb.com/semiconductors