

V_{DM}	=	2800 V
$I_{T(AV)M}$	=	2630 A
$I_{T(RMS)}$	=	4130 A
I_{TSM}	=	43×10^3 A
V_{T0}	=	0.85 V
r_T	=	0.16 mW

Bi-Directional Control Thyristor

5STB 24Q2800

Doc. No. 5SYA1053-02 May 07

- Two thyristors integrated into one wafer
- Patented free-floating silicon technology
- Designed for energy management and industrial applications
- Optimum power handling capability
- Interdigitated amplifying gate

The electrical and thermal data are valid for one-thyristor-half of the device (unless otherwise stated)

Blocking

Maximum rated values¹⁾

Parameter	Symbol	Conditions	5STB 24Q2800	Unit
Max repetitive peak forward blocking voltage	V_{RM}	$f = 50$ Hz, $t_p = 10$ ms, $T_{vj} = 5 \dots 125^\circ\text{C}$, Note 1	2800	V
Critical rate of rise of off-state voltage	dv/dt_{crit}	Exp. to 1880 V, $T_{vj} = 125^\circ\text{C}$	1000	V/ μs

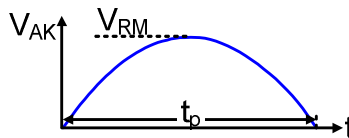

Characteristic values

Parameter	Symbol	Conditions	min	typ	max	Unit
Max reverse leakage current	I_{RM}	V_{RM} , $T_{vj} = 125^\circ\text{C}$			400	mA

Note 1: Voltage de-rating factor of 0.11% per $^\circ\text{C}$ is applicable for T_{vj} below $+5^\circ\text{C}$

Mechanical data

Maximum rated values¹⁾

Parameter	Symbol	Conditions	min	typ	max	Unit
Mounting force	F_M		81	90	108	kN
Acceleration	a	Device unclamped			50	m/s^2
Acceleration	a	Device clamped			100	m/s^2

Characteristic values

Parameter	Symbol	Conditions	min	typ	max	Unit
Weight	m				2.1	kg
Housing thickness	H	$F_M = 90$ kN, $T_a = 25^\circ\text{C}$	25.8		26.4	mm
Surface creepage distance	D_S		36			mm
Air strike distance	D_a		15			mm

1) Maximum rated values indicate limits beyond which damage to the device may occur

ABB Switzerland Ltd, Semiconductors reserves the right to change specifications without notice.



On-state

Maximum rated values ¹⁾

Parameter	Symbol	Conditions	min	typ	max	Unit
Average on-state current	$I_{T(AV)M}$	Half sine wave, $T_c = 70\text{ °C}$			2630	A
RMS on-state current	$I_{T(RMS)}$				4130	A
RMS on-state current	$I_{T(RMS)}$	Full sine wave, $T_c = 70\text{ °C}$			5840	A
Peak non-repetitive surge current	I_{TSM}	$t_p = 10\text{ ms}$, $T_{vj} = 125\text{ °C}$, sine wave after surge: $V_D = V_R = 0\text{ V}$			43.0×10^3	A
Limiting load integral	I^2t				9.25×10^6	A^2s
Peak non-repetitive surge current	I_{TSM}	$t_p = 8.3\text{ ms}$, $T_{vj} = 125\text{ °C}$, sine wave after surge: $V_D = V_R = 0\text{ V}$			46.0×10^3	A
Limiting load integral	I^2t				8.78×10^6	A^2s

Characteristic values

Parameter	Symbol	Conditions	min	typ	max	Unit
On-state voltage	V_T	$I_T = 3000\text{ A}$, $T_{vj} = 125\text{ °C}$			1.35	V
Threshold voltage	V_{T0}	$I_T = 1500\text{ A} - 4500\text{ A}$, $T_{vj} = 125\text{ °C}$			0.85	V
Slope resistance	r_T				0.16	$m\Omega$
Holding current	I_H	$T_{vj} = 25\text{ °C}$			250	mA
		$T_{vj} = 125\text{ °C}$			150	mA
Latching current	I_L	$T_{vj} = 25\text{ °C}$			500	mA
		$T_{vj} = 125\text{ °C}$			300	mA

Switching

Maximum rated values ¹⁾

Parameter	Symbol	Conditions	min	typ	max	Unit
Critical rate of rise of on-state current	di/dt_{crit}	$T_{vj} = 125\text{ °C}$, $I_{TRM} = 3000\text{ A}$, Cont. $f = 50\text{ Hz}$			250	$A/\mu s$
Critical rate of rise of on-state current	di/dt_{crit}	$V_D \leq 1880\text{ V}$, $I_{FG} = 2\text{ A}$, $t_r = 0.5\text{ }\mu s$ Cont. $f = 1\text{ Hz}$			500	$A/\mu s$
Circuit commutated turn-off time	t_q	$T_{vj} = 125\text{ °C}$, $I_{TRM} = 2000\text{ A}$, $V_R = 200\text{ V}$, $di_T/dt = -1.5\text{ A}/\mu s$, $V_D \leq 0.67 \cdot V_{RM}$, $dv_D/dt = 20\text{ V}/\mu s$,	400			μs
Critical rate of rise of commutating voltage	dv/dt_{com}	$T_{vj} = 125\text{ °C}$, $V_R \leq 0.67 \cdot V_{RM}$			500	$V/\mu s$

Characteristic values

Parameter	Symbol	Conditions	min	typ	max	Unit
Reverse recovery charge	Q_{rr}	$T_{vj} = 125\text{ °C}$, $I_{TRM} = 2000\text{ A}$, $V_R = 200\text{ V}$, $di_T/dt = -1.5\text{ A}/\mu s$	1000		2100	μAs
Reverse recovery current	I_{RM}		30		80	A
Gate turn-on delay time	t_{gd}	$T_{vj} = 25\text{ °C}$, $V_D = 0.4 \cdot V_{RM}$, $I_{FG} = 2\text{ A}$, $t_r = 0.5\text{ }\mu s$			3	μs

Triggering

Maximum rated values ¹⁾

Parameter	Symbol	Conditions	min	typ	max	Unit
Peak forward gate voltage	V_{FGM}				12	V
Max. rated peak forward gate current	I_{FGM}				10	A
Peak reverse gate voltage	V_{RGM}				10	V
Max. rated gate power loss	P_G	For DC gate current			3	W
Max. rated peak forward gate power	$P_{GM(AV)}$		see Fig. 9			W

Characteristic values

Parameter	Symbol	Conditions	min	typ	max	Unit
Gate trigger voltage	V_{GT}	$T_{vj} = 25\text{ °C}$			2.6	V
Gate trigger current	I_{GT}	$T_{vj} = 25\text{ °C}$			400	mA
Gate non-trigger voltage	V_{GD}	$V_D = 0.4 \times V_{RM}$, $T_{vj} = 125\text{ °C}$	0.3			V
Gate non-trigger current	I_{GD}	$V_D = 0.4 \times V_{RM}$	10			mA

Thermal

Maximum rated values ¹⁾

Parameter	Symbol	Conditions	min	typ	max	Unit
Operating junction temperature range	T_{vj}				125	°C
Storage temperature range	T_{stg}		-40		140	°C

Characteristic values

Parameter	Symbol	Conditions	min	typ	max	Unit
Thermal resistance junction to case (Valid for one thyristor half no heat flow to the second half.)	$R_{th(j-c)}$	Double-side cooled $F_m = 81...108\text{ kN}$			10	K/kW
	$R_{th(j-c)}$	Single-side cooled $F_m = 81...108\text{ kN}$			20	K/kW
Thermal resistance case to heatsink	$R_{th(c-h)}$	Double-side cooled $F_m = 81...108\text{ kN}$			2	K/kW
	$R_{th(c-h)}$	Single-side cooled $F_m = 81...108\text{ kN}$			4	K/kW

Analytical function for transient thermal impedance:

$$Z_{th(j-c)}(t) = \sum_{i=1}^n R_i (1 - e^{-t/\tau_i})$$

i	1	2	3	4
R_i (K/kW)	6.500	1.470	1.310	0.710
τ_i (s)	0.5205	0.1075	0.0194	0.0073

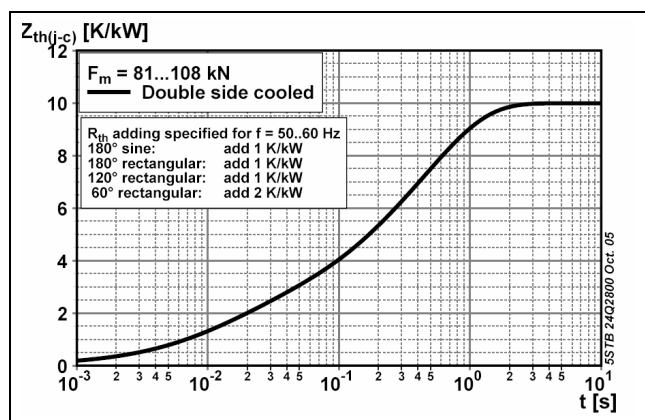

Fig. 1 Transient thermal impedance (junction-to-case) vs. time

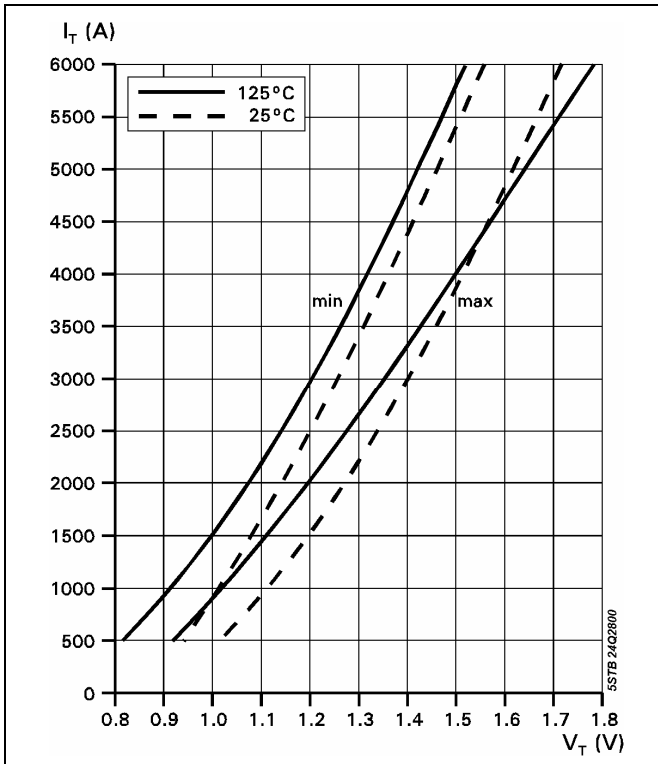

Fig. 2 On-state voltage characteristics

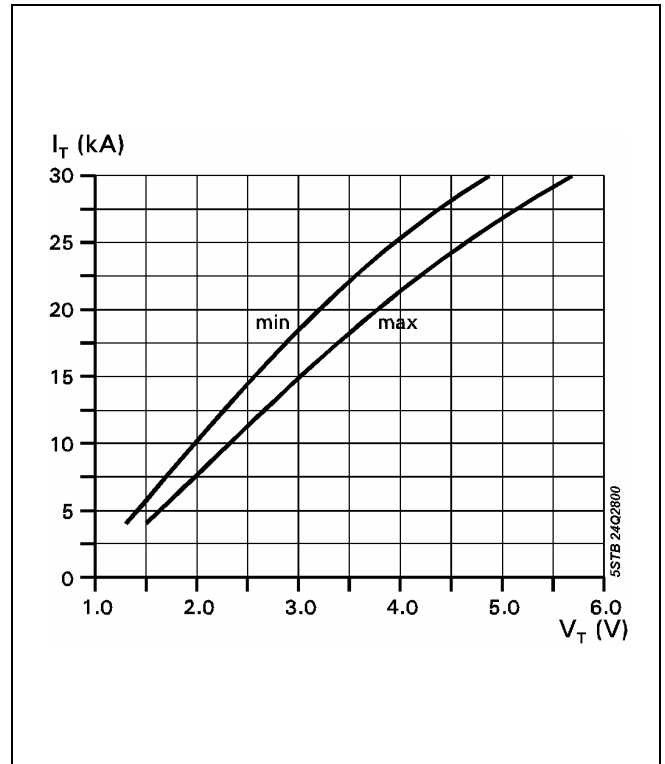

Fig. 3 On-state characteristics.
 $T_j = 125^\circ\text{C}$, 10ms half sine.

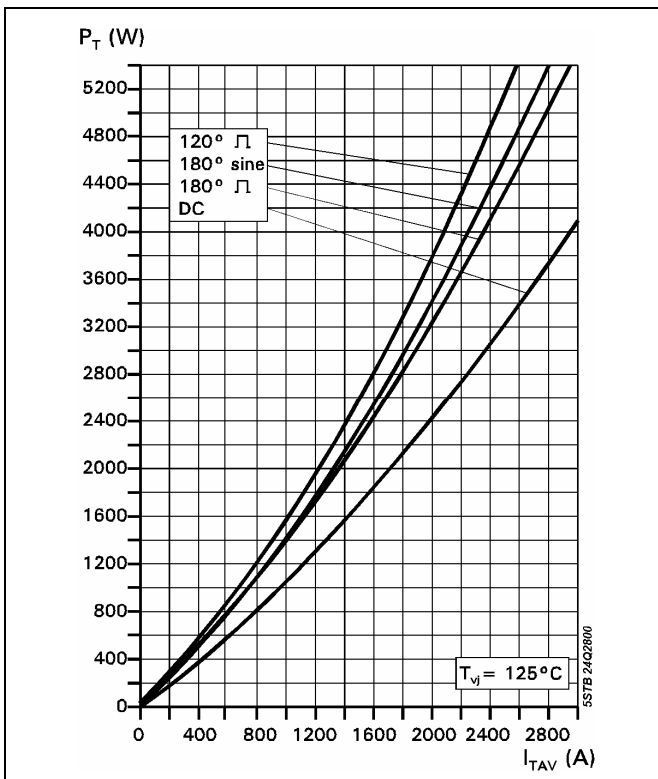

Fig. 4 On-state power dissipation vs. mean on-state current. Turn-on losses excluded.

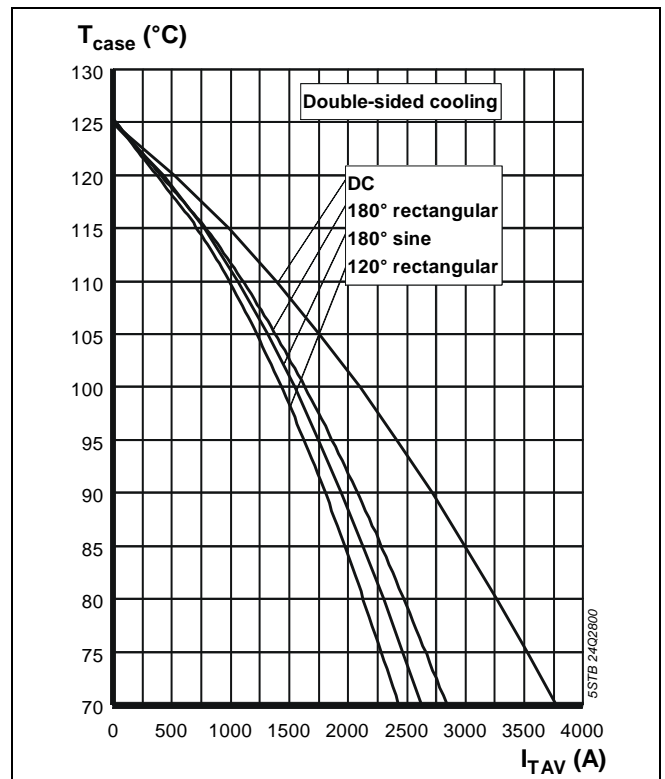

Fig. 5 Max. permissible case temperature vs. mean on-state current. Switching losses ignored.

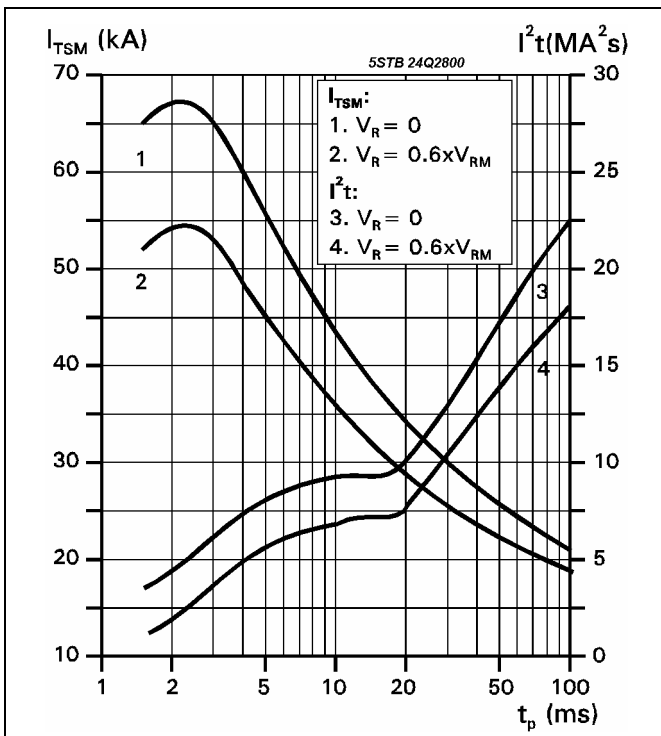

Fig. 6 Surge on-state current vs. pulse length. Half-sine wave.

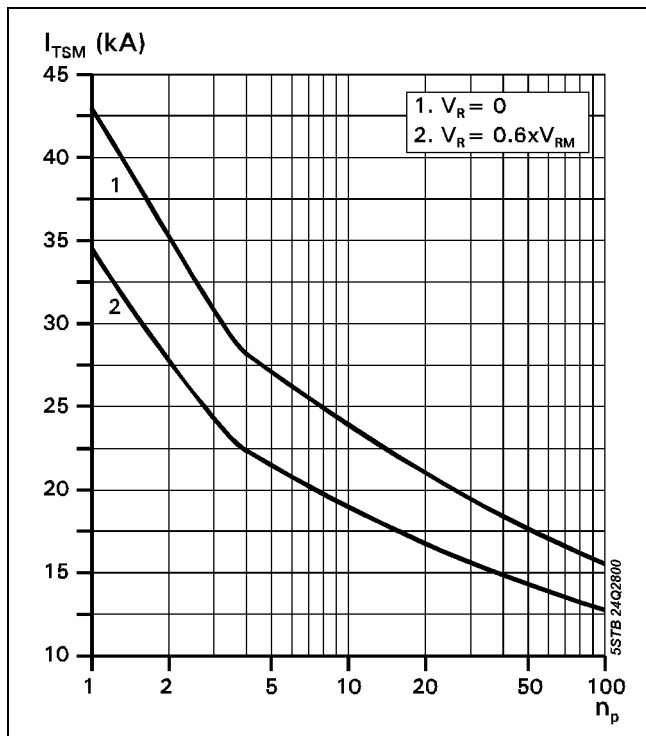

Fig. 7 Surge on-state current vs. number of pulses. Half-sine wave, 10 ms, 50Hz.

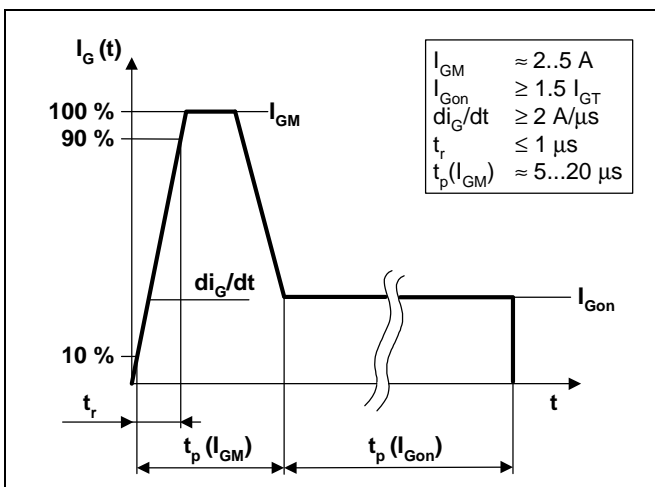

Fig. 8 Recommended gate current waveform

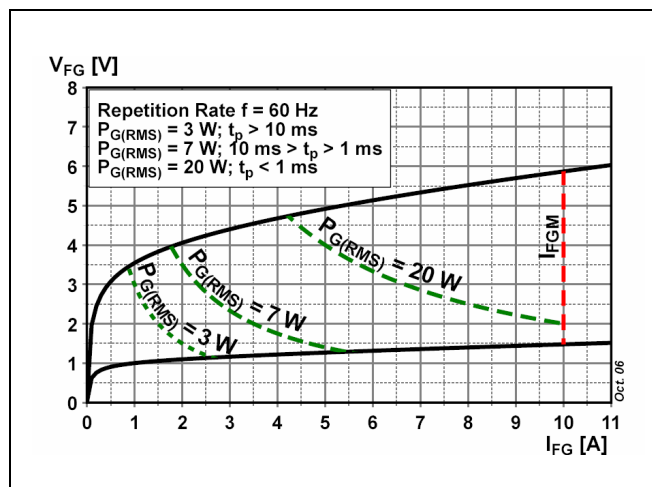

Fig. 9 Max. peak gate power loss

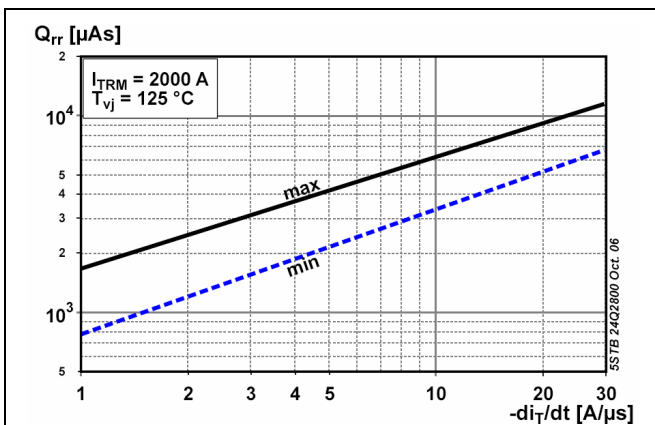

Fig. 10 Reverse recovery charge vs. decay rate of on-state current

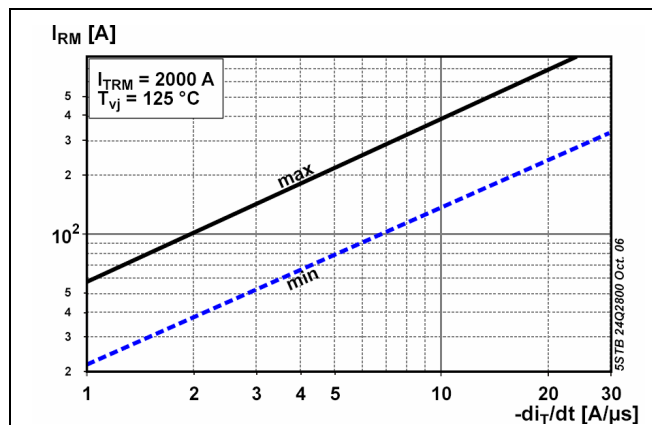

Fig. 11 Peak reverse recovery current vs. decay rate of on-state current

Turn-on and Turn-off losses

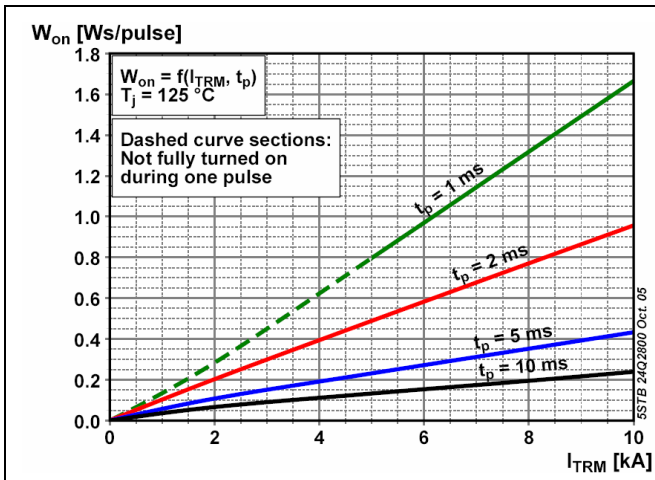

Fig. 12 Turn-on energy, half sinusoidal waves

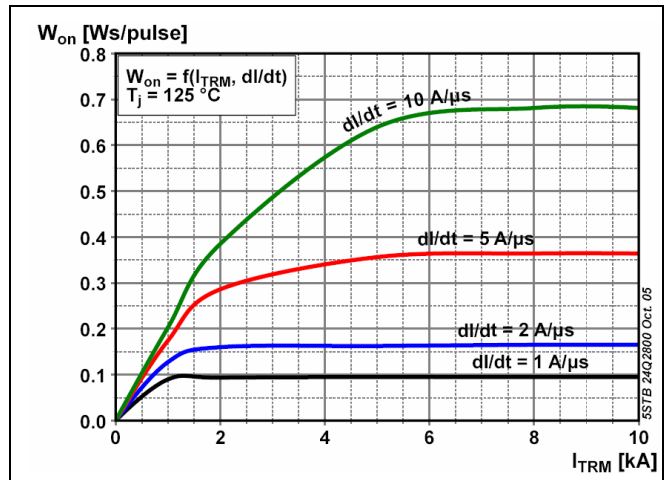

Fig. 13 Turn-on energy, rectangular waves

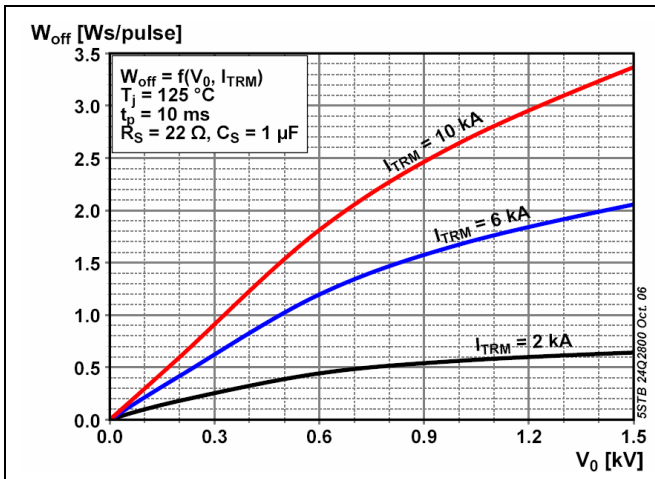

Fig. 14 Turn-off energy, half sinusoidal waves

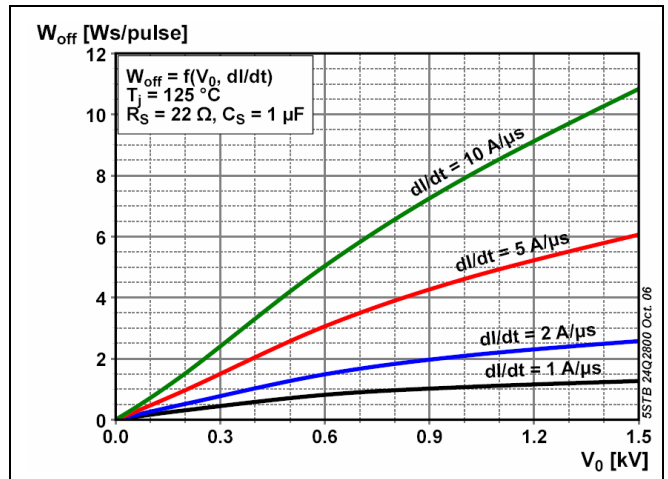

Fig. 15 Turn-off energy, rectangular waves

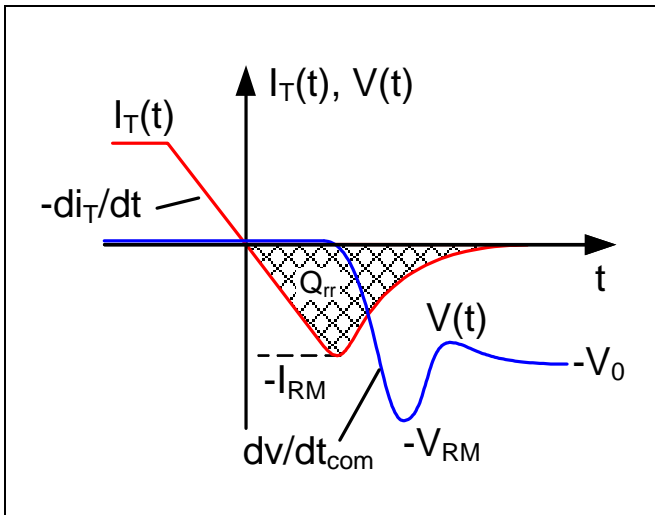

Fig. 16 Current and voltage waveforms at turn-off

Total power loss for repetitive waveforms:

$$P_{TOT} = P_T + W_{on} \cdot f + W_{off} \cdot f$$

where

$$P_T = \frac{1}{T} \int_0^T I_T \cdot V_T(I_T) dt$$

Fig. 17 Relationships for power loss

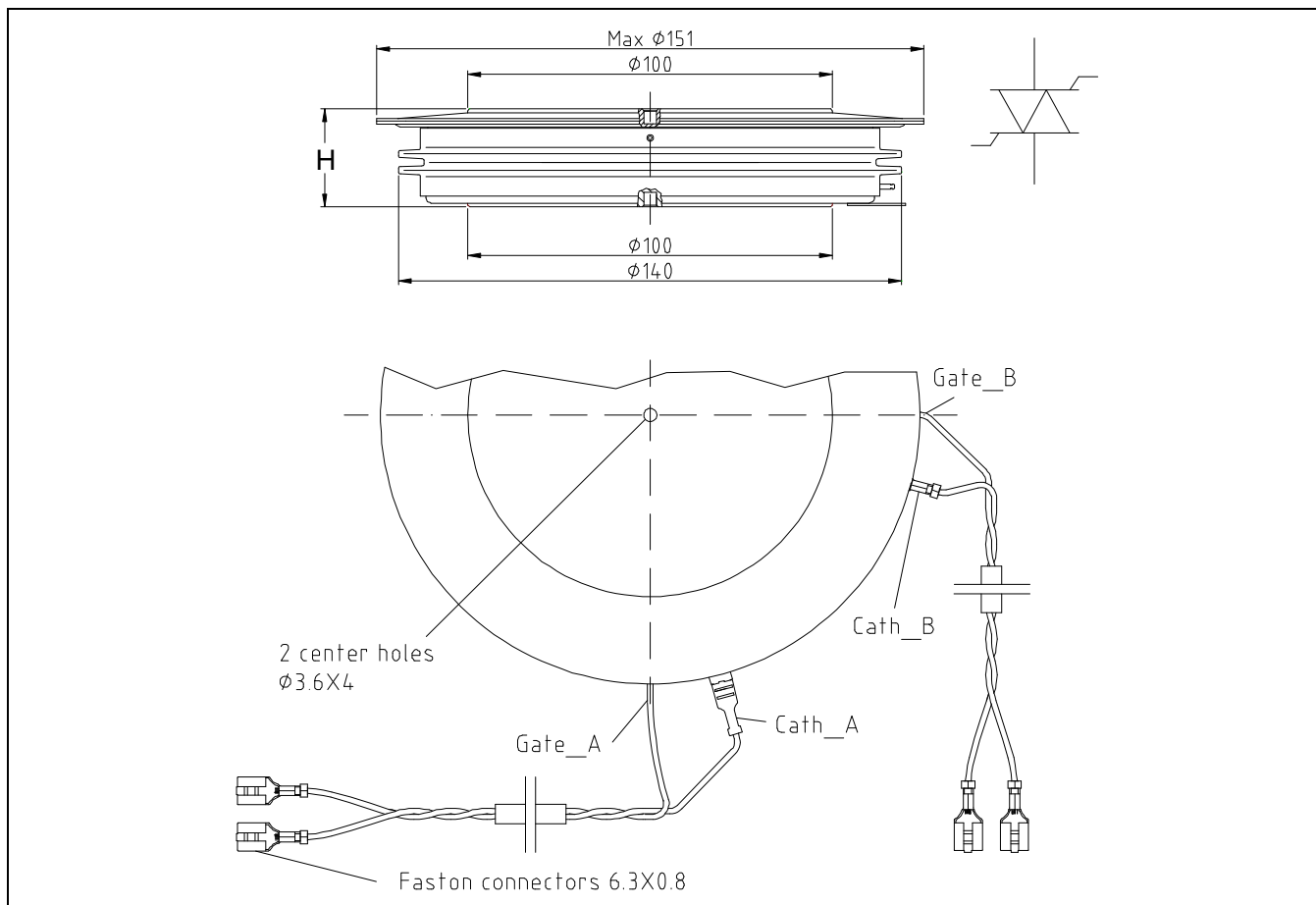

Fig. 18 Device Outline Drawing

Related documents:

5SYA 2020	Design of RC-Snubber for Phase Control Applications
5SYA 2049	Voltage definitions for phase control thyristors and diodes
5SYA 2051	Voltage ratings of high power semiconductors
5SYA 2034	Gate-Drive Recommendations for PCT's
5SYA 2036	Recommendations regarding mechanical clamping of Press Pack High Power Semiconductors
5SZK 9104	Specification of environmental class for pressure contact diodes, PCTs and GTO, STORAGE available on request, please contact factory
5SZK 9105	Specification of environmental class for pressure contact diodes, PCTs and GTO, TRANSPORTATION available on request, please contact factory

Please refer to <http://www.abb.com/semiconductors> for current version of documents.

ABB Switzerland Ltd, Semiconductors reserves the right to change specifications without notice.



ABB Switzerland Ltd
Semiconductors
 Fabrikstrasse 3
 CH-5600 Lenzburg, Switzerland

Doc. No. 5SYA1053-02 May 07

Telephone +41 (0)58 586 1419
 Fax +41 (0)58 586 1306
 Email abbsem@ch.abb.com
 Internet www.abb.com/semiconductors