



# 5STF 15F2040

Old part no. TR 918F-1490-20

## Medium Frequency Thyristor

### Properties

- § Amplifying gate
- § High operational capability
- § Optimized turn-on and turn-off parameters
- § High operating frequency

### Applications

- § Power switching applications

### Key Parameters

$V_{DRM}, V_{RRM}$	= 2 000	V
$I_{TAV}$	= 1 489	A
$I_{TSM}$	= 17.0	kA
$V_{TO}$	= 1.605	V
$r_T$	= 0.144	m $\Omega$
$t_q$	= 40.0	$\mu$ s

### Types

	$V_{RRM}, V_{DRM}$
5STF 15F2040..2050	2 000 V
5STF 15F1840..1850	1 800 V

Conditions:  
 $T = -40 \div 125$  °C, half sine waveform,  
 $f = 50$  Hz, note 1

### Mechanical Data

$F_m$	Mounting force	22 $\pm$ 2 kN
$m$	Weight	0.48 kg
$D_s$	Surface creepage distance	25 mm
$D_a$	Air strike distance	13 mm

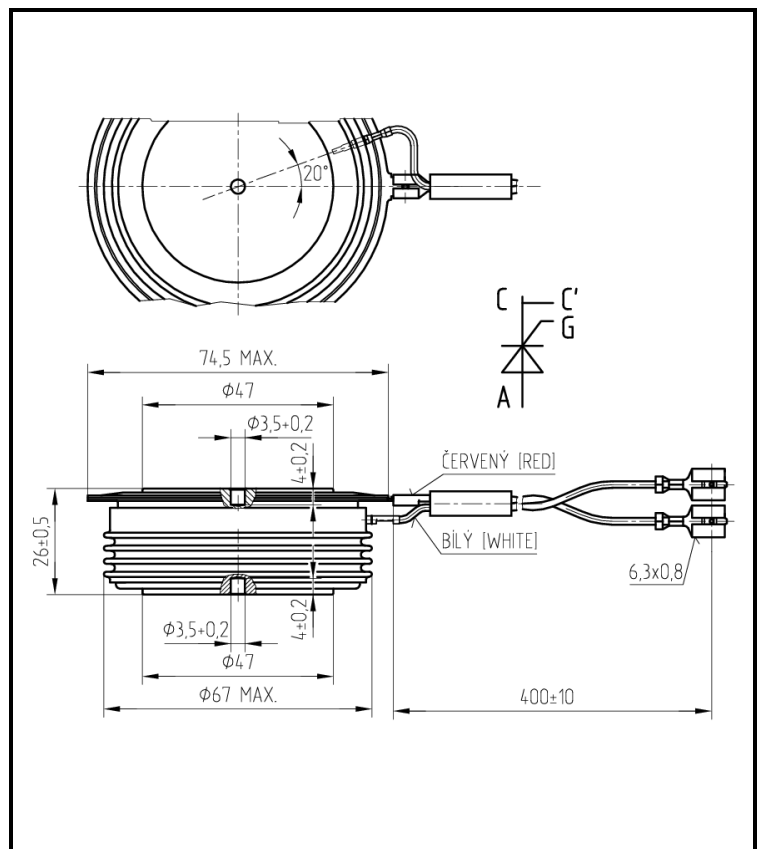


Fig. 1 Case



ABB s.r.o.

Novodvorska 1768/138a, 142 21 Praha 4, Czech Republic

tel.: +420 261 306 250, <http://www.abb.com/semiconductors>

<b>Maximum Ratings</b>			<b>Maximum Limits</b>	<b>Unit</b>
$V_{RRM}$ $V_{DRM}$	<b>Repetitive peak reverse and off-state voltage</b> $T_j = -40 \div 125 \text{ }^\circ\text{C}$ , note 1	5STF 15F2040..2050 5STF 15F1840..1850	2 000 1 800	V
$I_{TRMS}$	<b>RMS on-state current</b> $T_c = 70 \text{ }^\circ\text{C}$ , half sine waveform, $f = 50 \text{ Hz}$		2 338	A
$I_{TAVm}$	<b>Average on-state current</b> $T_c = 70 \text{ }^\circ\text{C}$ , half sine waveform, $f = 50 \text{ Hz}$		1 489	A
$I_{TSM}$	<b>Peak non-repetitive surge</b> half sine pulse, $V_R = 0 \text{ V}$	$t_p = 10 \text{ ms}$ $t_p = 8.3 \text{ ms}$	17 000 18 200	A
$\int i^2 t$	<b>Limiting load integral</b> half sine pulse, $V_R = 0 \text{ V}$	$t_p = 10 \text{ ms}$ $t_p = 8.3 \text{ ms}$	1 450 000 1 370 000	A <sup>2</sup> s
$(di_T/dt)_{cr}$	<b>Critical rate of rise of on-state current</b> $I_T = I_{TAVm}$ , half sine waveform, $f = 50 \text{ Hz}$ , $V_D = 2/3 V_{DRM}$ , $t_r = 0.3 \text{ } \mu\text{s}$ , $I_{GT} = 2 \text{ A}$		800	A/ $\mu\text{s}$
$(dv_D/dt)_{cr}$	<b>Critical rate of rise of off-state voltage</b> $V_D = 2/3 V_{DRM}$		1 000	V/ $\mu\text{s}$
$P_{GAVm}$	<b>Maximum average gate power losses</b>		3	W
$I_{FGM}$	<b>Peak gate current</b>		10	A
$V_{FGM}$	<b>Peak gate voltage</b>		12	V
$V_{RGM}$	<b>Reverse peak gate voltage</b>		10	V
$T_{jmin} - T_{jmax}$	<b>Operating temperature range</b>		-40 ÷ 125	°C
$T_{stgmin} - T_{stgmax}$	<b>Storage temperature range</b>		-40 ÷ 125	°C

Unless otherwise specified  $T_j = 125 \text{ }^\circ\text{C}$

Note 1: De-rating factor of 0.13%  $V_{RRM}$  or  $V_{DRM}$  per  $^\circ\text{C}$  is applicable for  $T_j$  below  $25 \text{ }^\circ\text{C}$

Characteristics		Value			Unit
		min.	typ.	max.	
$V_{TM}$	<b>Maximum peak on-state voltage</b> $I_{TM} = 2\ 000\ A$			<b>1.890</b>	<b>V</b>
$V_{T0}$	<b>Threshold voltage</b>			<b>1.605</b>	<b>V</b>
$r_T$	<b>Slope resistance</b> $I_{T1} = 2\ 340\ A, I_{T2} = 7\ 021\ A$			<b>0.144</b>	<b>mW</b>
$I_{DM}$	<b>Peak off-state current</b> $V_D = V_{DRM}$			<b>100</b>	<b>mA</b>
$I_{RM}$	<b>Peak reverse current</b> $V_R = V_{RRM}$			<b>100</b>	<b>mA</b>
$t_{gd}$	<b>Delay time</b> $T_j = 25\ ^\circ C, V_D = 0.4\ V_{DRM}, I_{TM} = I_{TAVm},$ $t_r = 0.3\ \mu s, I_{GT} = 2\ A$			<b>2.0</b>	<b><math>\mu s</math></b>
$t_{q1}$	<b>Turn-off time</b> $I_T = 1\ 000\ A, di_T/dt = -50\ A/\mu s,$ $V_R = 100\ V, V_D = 2/3\ V_{DRM},$ $dv_D/dt = 50\ V/\mu s$	<b>group of <math>t_q</math></b> <b>5STF 15F2040</b> <b>5STF 15F1840</b>  <b>5STF 15F2050</b> <b>5STF 15F1850</b>		<b>40.0</b>  <b>50.0</b>	<b><math>\mu s</math></b>
$Q_{rr}$	<b>Recovery charge</b> <i>the same conditions as at <math>t_{q1}</math></i>			<b>1000</b>	<b><math>\mu C</math></b>
$I_{rrM}$	<b>Reverse recovery current</b> <i>the same conditions as at <math>t_{q1}</math></i>			<b>200</b>	<b>A</b>
$I_H$	<b>Holding current</b>	$T_j = 25\ ^\circ C$ $T_j = 125\ ^\circ C$		<b>250</b> <b>150</b>	<b>mA</b>
$I_L$	<b>Latching current</b>	$T_j = 25\ ^\circ C$ $T_j = 125\ ^\circ C$		<b>1 500</b> <b>1 000</b>	<b>mA</b>
$V_{GT}$	<b>Gate trigger voltage</b> $V_D = 12V, I_T = 4\ A$	$T_j = -40\ ^\circ C$ $T_j = 25\ ^\circ C$ $T_j = 125\ ^\circ C$	<b>0.25</b>	<b>4</b> <b>3</b> <b>2</b>	<b>V</b>
$I_{GT}$	<b>Gate trigger current</b> $V_D = 12V, I_T = 4\ A$	$T_j = -40\ ^\circ C$ $T_j = 25\ ^\circ C$ $T_j = 125\ ^\circ C$	<b>10</b>	<b>1000</b> <b>500</b> <b>300</b>	<b>mA</b>

Unless otherwise specified  $T_j = 125\ ^\circ C$

Thermal Parameters		Value	Unit
$R_{thjc}$	Thermal resistance junction to case <i>double side cooling</i>	16.0	K/kW
	<i>anode side cooling</i>	25.0	
	<i>cathode side cooling</i>	45.0	
$R_{thch}$	Thermal resistance case to heatsink <i>double side cooling</i>	4.0	K/kW
	<i>single side cooling</i>	8.0	

### Transient Thermal Impedance

Analytical function for transient thermal impedance

$$Z_{thjc} = \sum_{i=1}^4 R_i (1 - \exp(-t/\tau_i))$$

Conditions:

$F_m = 22 \pm 2$  kN, Double side cooled

Correction for periodic waveforms

180° sine:	add 1.3 K/kW
180° rectangular:	add 1.8 K/kW
120° rectangular:	add 3.0 K/kW
60° rectangular:	add 5.1 K/kW

$i$	1	2	3	4
$\tau_i$ (s)	0.4653	0.1533	0.0375	0.0034
$R_i$ (K/kW)	5.50	7.24	2.00	1.30



Fig. 2 Dependence transient thermal impedance junction to case on square pulse

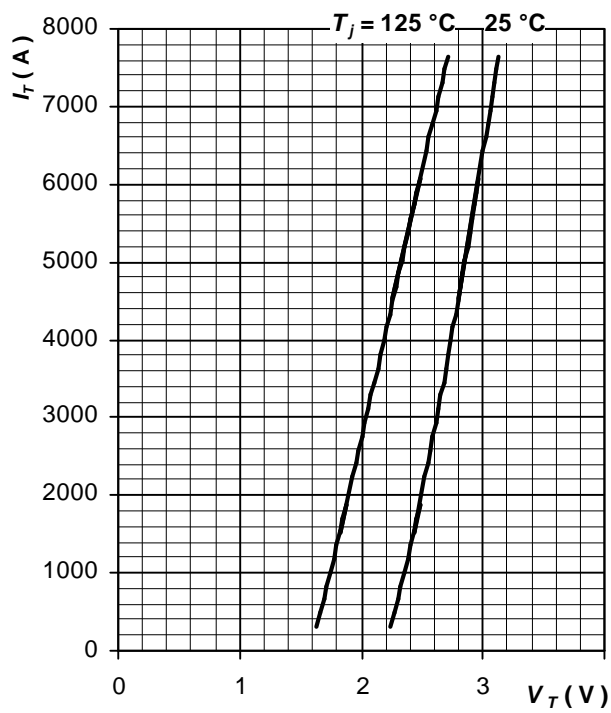
**On-State Characteristics**

Fig. 3 Maximum on-state characteristics

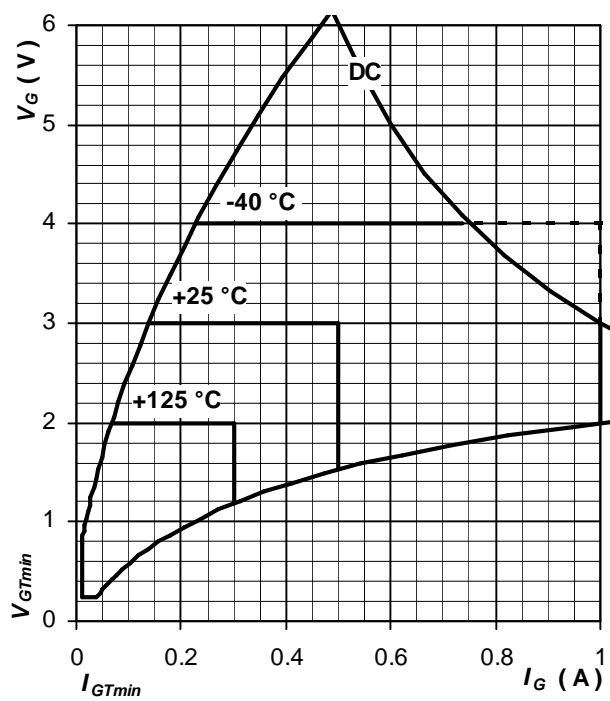
**Gate Trigger Characteristics**

Fig. 4 Gate trigger characteristics

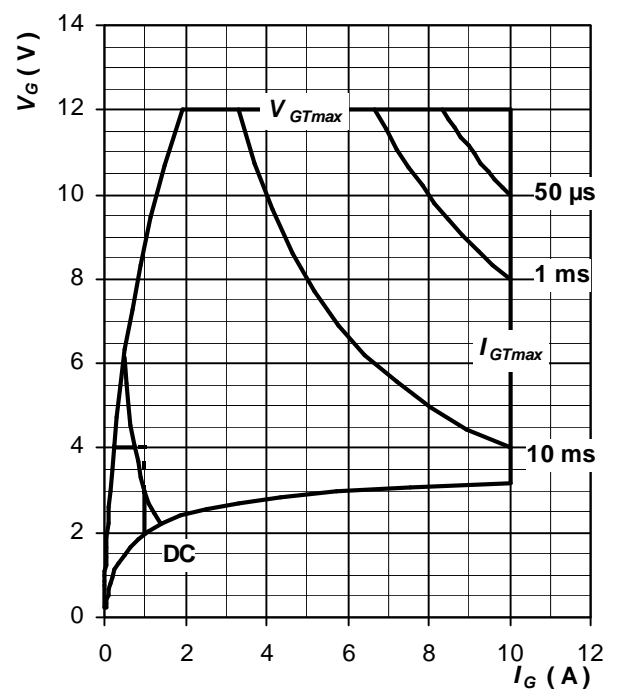


Fig. 5 Maximum peak gate power loss

## Surge Characteristics

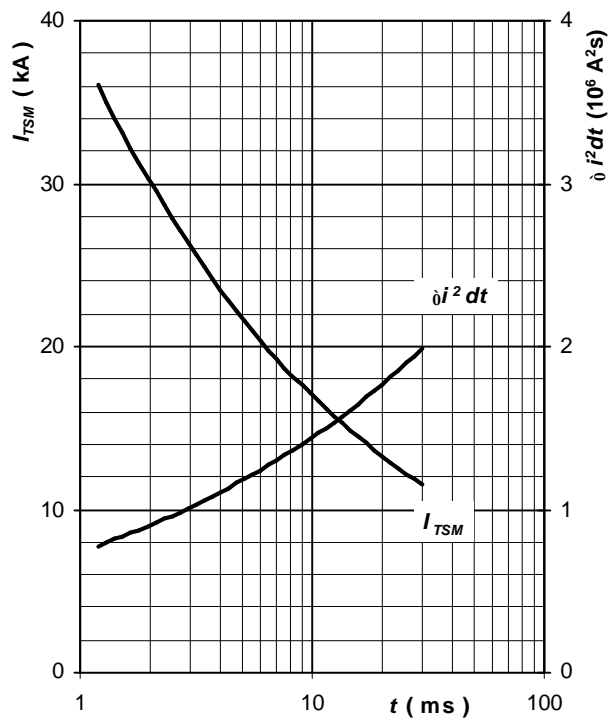


Fig. 6 Surge on-state current vs. pulse length, half sine wave, single pulse,  $V_R = 0 \text{ V}$ ,  $T_j = T_{jmax}$

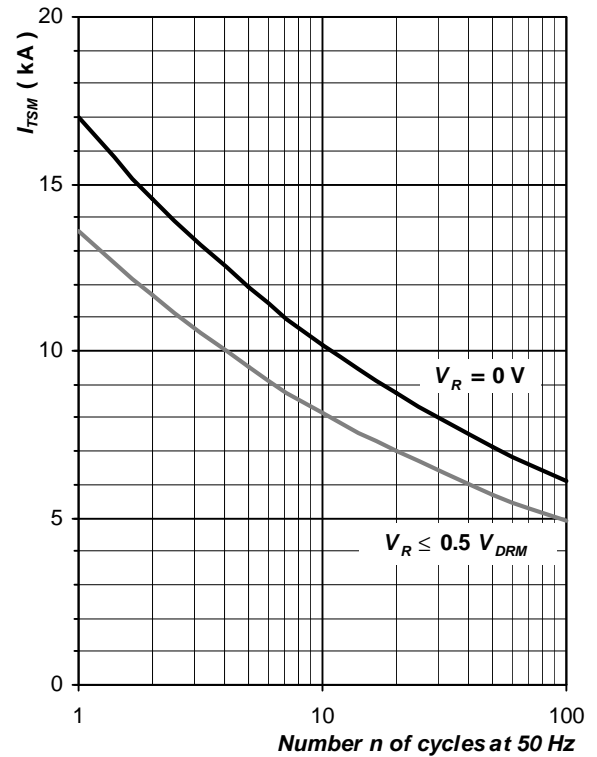


Fig. 7 Surge on-state current vs. number of pulses, half sine wave,  $T_j = T_{jmax}$

**Power Loss and Maximum Case Temperature Characteristics**

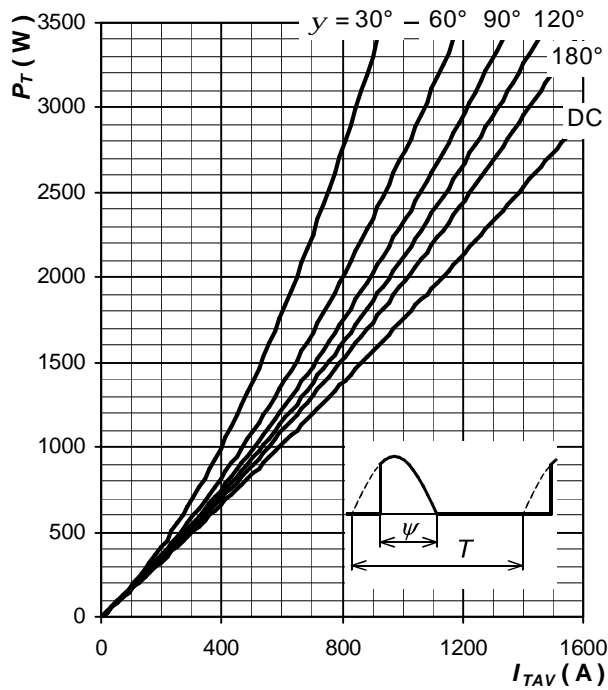


Fig. 8 On-state power loss vs. average on-state current, sine waveform,  $f = 50$  Hz,  $T = 1/f$

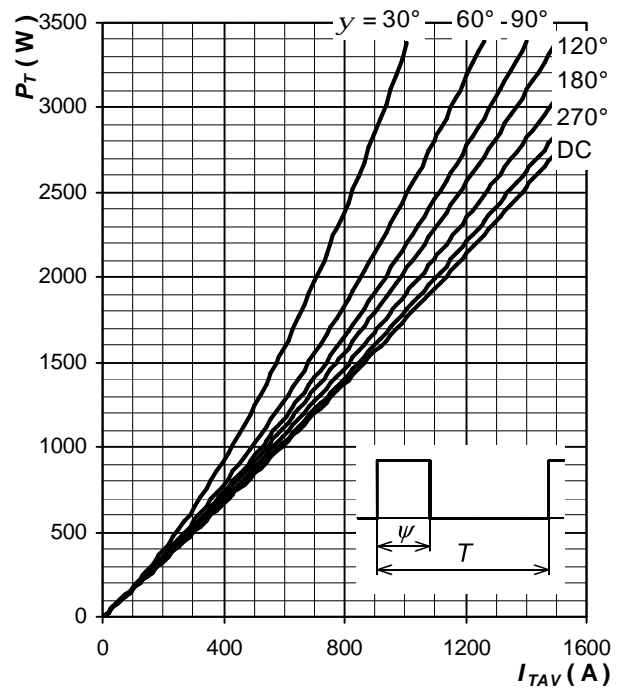


Fig. 9 On-state power loss vs. average on-state current, square waveform,  $f = 50$  Hz,  $T = 1/f$

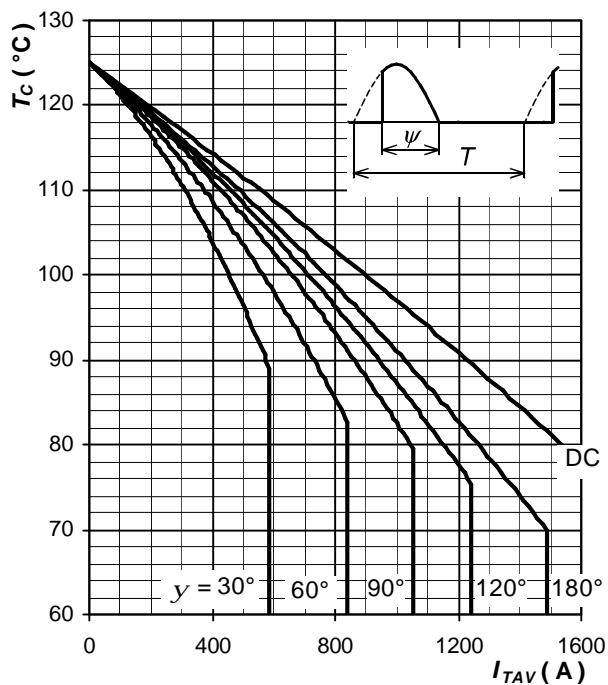


Fig. 10 Max. case temperature vs. aver. on-state current, sine waveform,  $f = 50$  Hz,  $T = 1/f$

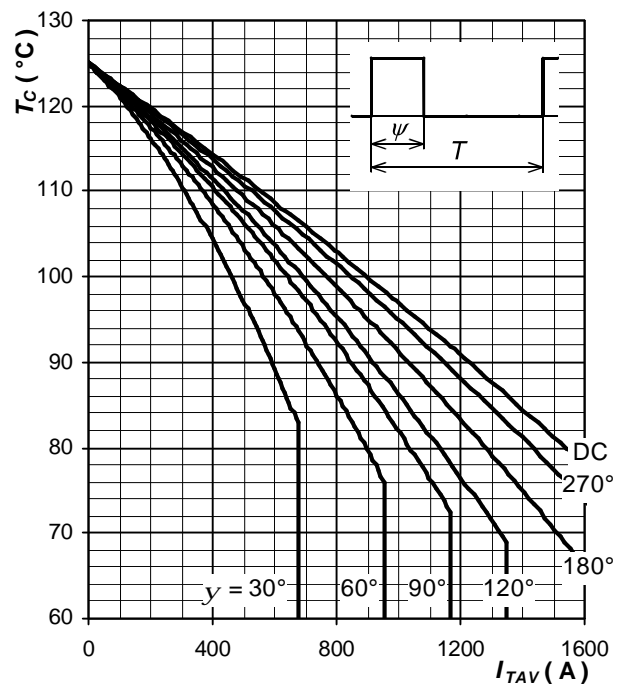


Fig. 11 Max. case temperature vs. aver. on-state current, square waveform,  $f = 50$  Hz,  $T = 1/f$

Note 2: Figures number 8 , 11 have been calculated without considering any turn-on and turn-off losses. They are valid for  $f = 50$  or  $60$  Hz operation.

**Turn-off Time, Parameter Relationship**

Maximum values of turn-off time at application specific conditions are given by using this formula:

$$t_q = t_{q1} \cdot \frac{t_q}{t_{q1}}(T_j) \cdot \frac{t_q}{t_{q1}}(dv_D / dt) \cdot \frac{t_q}{t_{q1}}(-di_T / dt)$$

where:

$t_{q1}$  is turn-off time at standard conditions, see section "Characteristics"

$\frac{t_q}{t_{q1}}(T_j)$  is factor to be taken from fig. 12

$\frac{t_q}{t_{q1}}(dv_D / dt)$  is factor to be taken from fig. 13

$\frac{t_q}{t_{q1}}(-di_T / dt)$  is factor to be taken from fig. 14

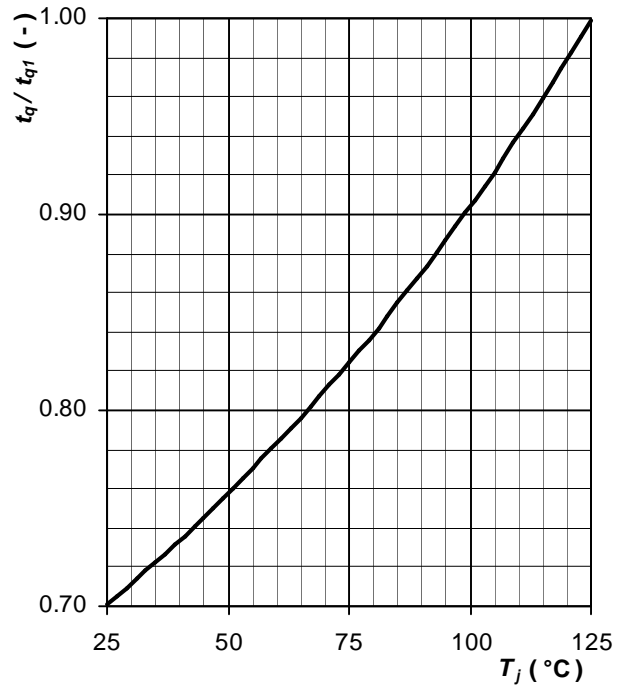


Fig. 12 Normalised maximum turn-off time vs. junction temperature

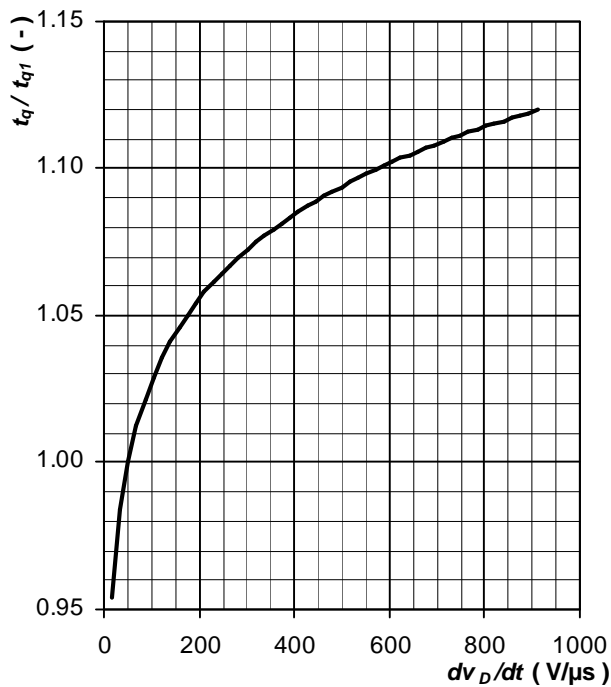


Fig. 13 Normalised maximum turn-off time vs. rate of rise of off-state voltage

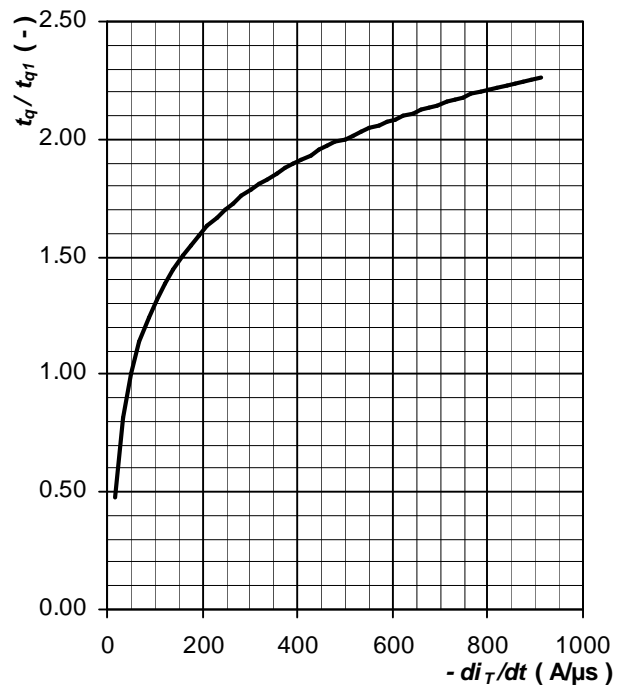


Fig. 14 Normalised maximum turn-off time vs. rate of fall of on-state current



### Turn-on Characteristics



Fig. 15 Typical waveforms and definition of symbols at turn-on of a thyristor

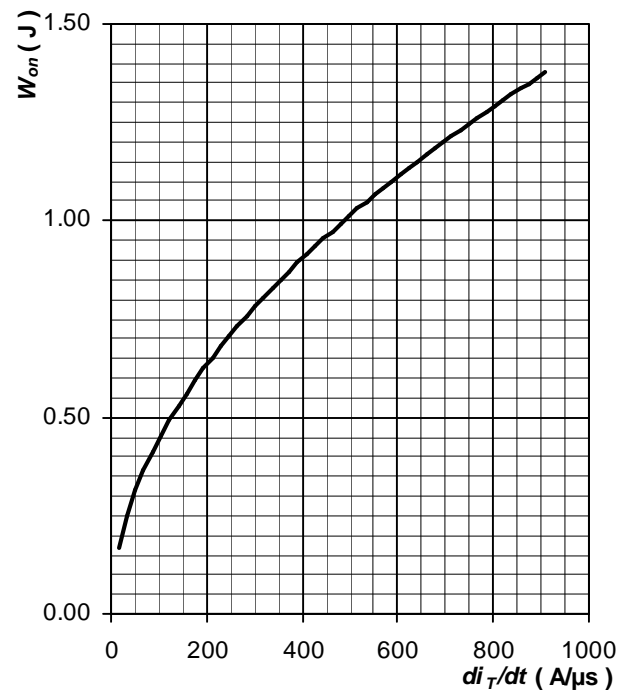


Fig. 16 Maximum turn-on energy per pulse vs. rate of rise on-state current,  $T_j = T_{jmax}$

**Turn-off Characteristics**

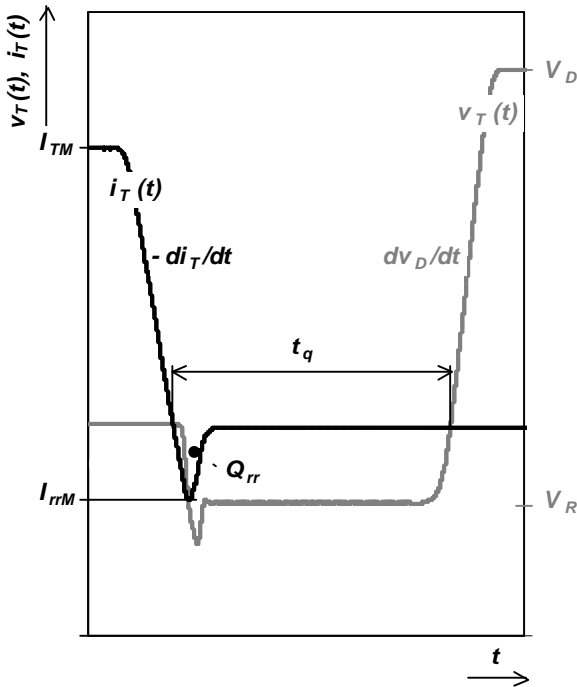


Fig. 17 Typical waveforms and definition of symbols at turn-off of a thyristor, inductive switching without RC snubber

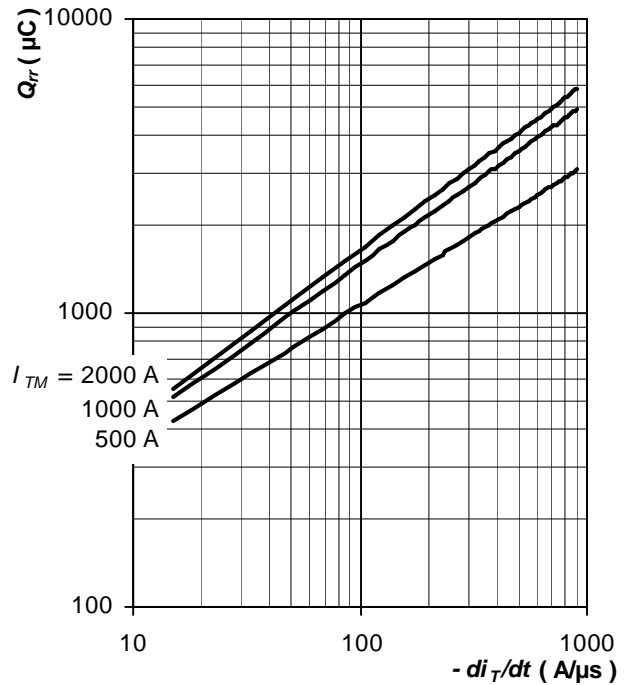


Fig. 18 Max. recovered charge vs. rate of fall on-state current, trapezoid pulse,  $V_R = 100 \text{ V}$ ,  $T_j = T_{jmax}$

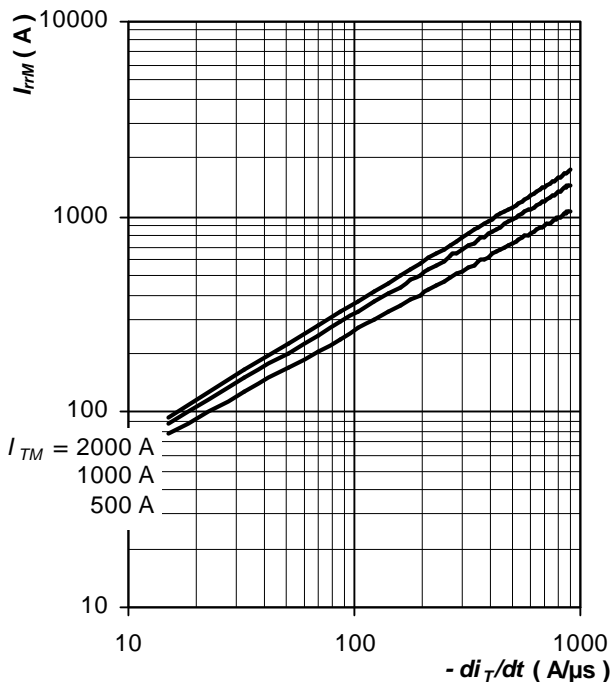


Fig. 19 Max. reverse recovery current vs. rate of fall on-state current, trapezoid pulse,  $V_R = 100 \text{ V}$ ,  $T_j = T_{jmax}$

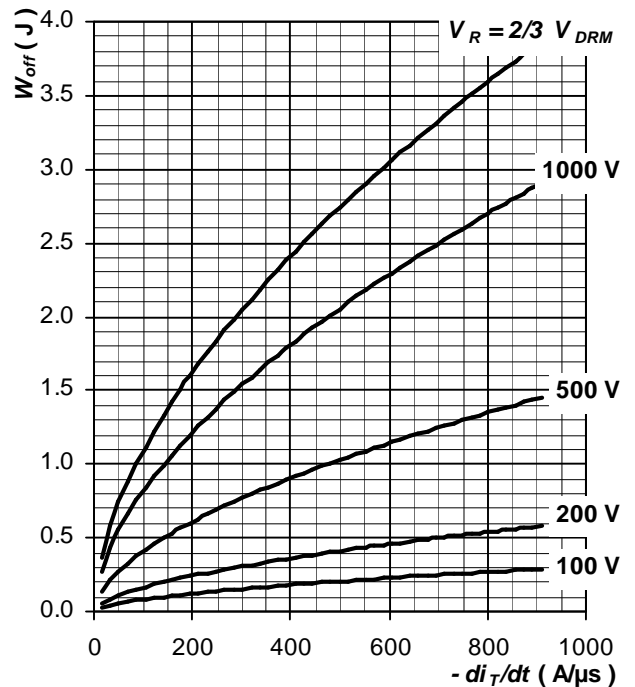


Fig. 20 Maximum turn-off energy per pulse vs. rate of fall on-state current, trapezoid pulse, inductive switching without RC snubber,  $I_{TM} = 2\ 000 \text{ A}$ ,  $T_j = T_{jmax}$

## Frequency Ratings

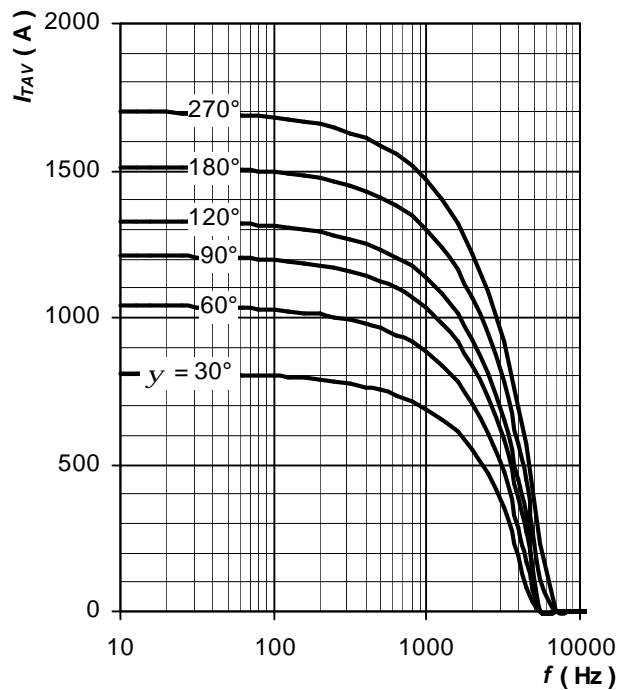


Fig. 21 Average on-state current vs. frequency, trapezoid waveform,  $T_C = 70\text{ }^\circ\text{C}$ ,  $di_T/dt = \pm 100\text{ A}/\mu\text{s}$ ,  $V_R = 100\text{ V}$

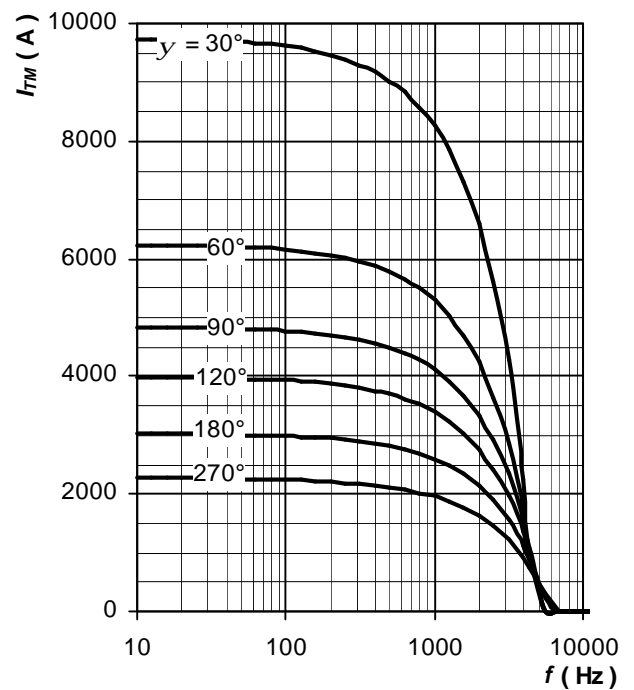


Fig. 22 Maximum on-state current vs. frequency, trapezoid waveform,  $T_C = 70\text{ }^\circ\text{C}$ ,  $di_T/dt = \pm 100\text{ A}/\mu\text{s}$ ,  $V_R = 100\text{ V}$

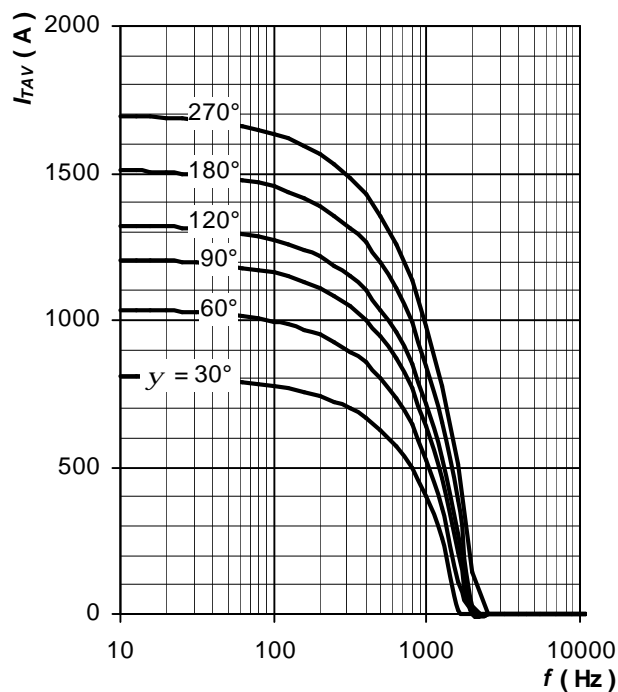


Fig. 23 Average on-state current vs. frequency, trapezoid waveform,  $T_C = 70\text{ }^\circ\text{C}$ ,  $di_T/dt = \pm 100\text{ A}/\mu\text{s}$ ,  $V_R = 2/3 V_{DRM}$

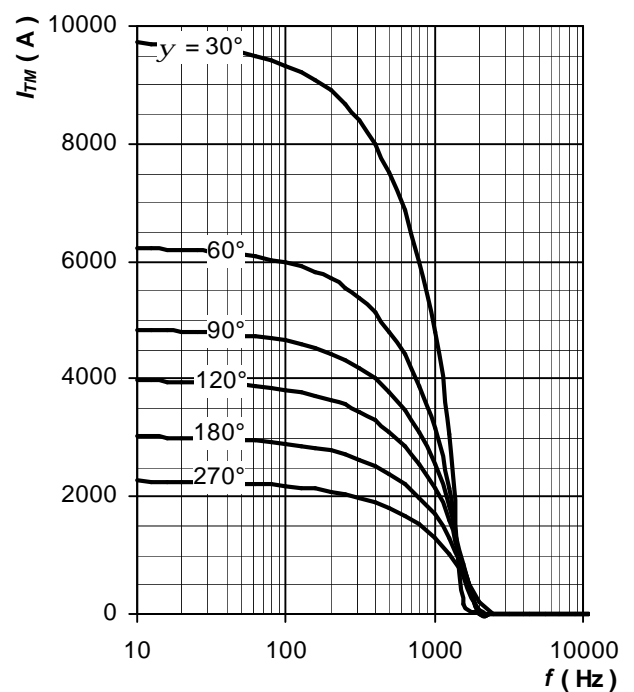


Fig. 24 Maximum on-state current vs. frequency, trapezoid waveform,  $T_C = 70\text{ }^\circ\text{C}$ ,  $di_T/dt = \pm 100\text{ A}/\mu\text{s}$ ,  $V_R = 2/3 V_{DRM}$

**Frequency Ratings**

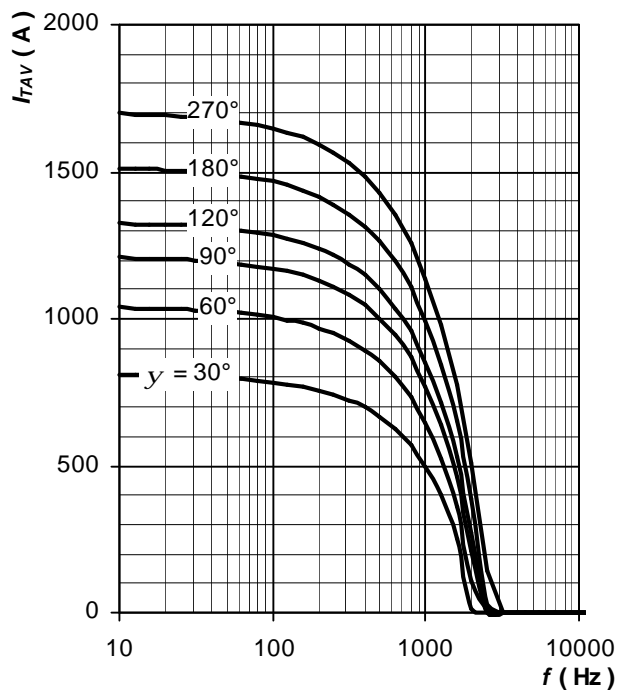


Fig. 25 Average on-state current vs. frequency, trapezoid waveform,  $T_C = 70^\circ\text{C}$ ,  $di_T/dt = \pm 500\text{ A}/\mu\text{s}$ ,  $V_R = 100\text{ V}$

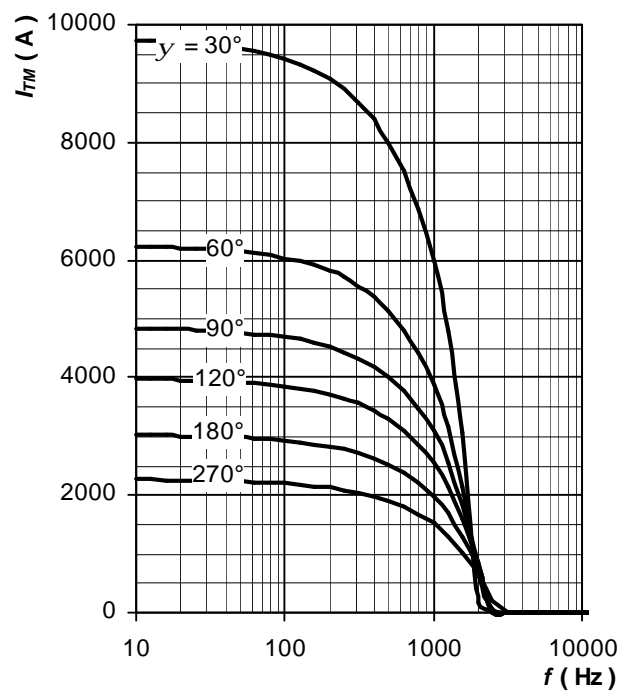


Fig. 26 Maximum on-state current vs. frequency, trapezoid waveform,  $T_C = 70^\circ\text{C}$ ,  $di_T/dt = \pm 500\text{ A}/\mu\text{s}$ ,  $V_R = 100\text{ V}$

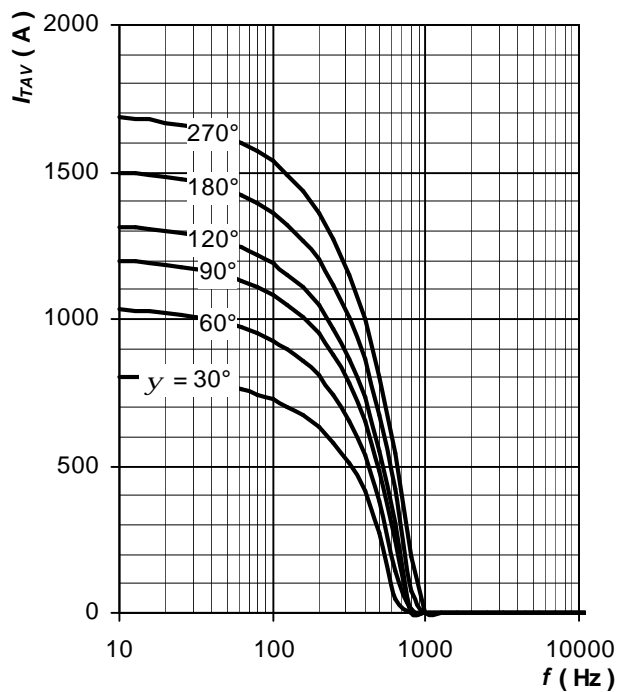


Fig. 27 Average on-state current vs. frequency, trapezoid waveform,  $T_C = 70^\circ\text{C}$ ,  $di_T/dt = \pm 500\text{ A}/\mu\text{s}$ ,  $V_R = 2/3 V_{DRM}$

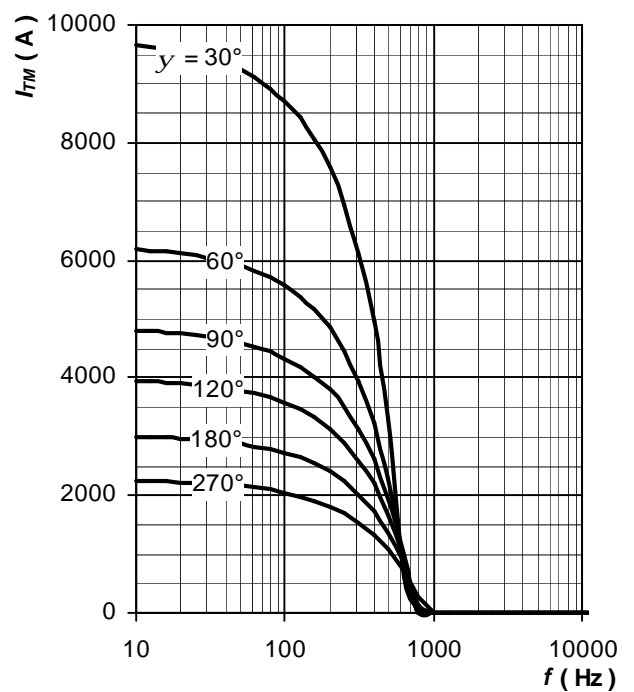


Fig. 28 Maximum on-state current vs. frequency, trapezoid waveform,  $T_C = 70^\circ\text{C}$ ,  $di_T/dt = \pm 500\text{ A}/\mu\text{s}$ ,  $V_R = 2/3 V_{DRM}$

**Frequency Ratings**

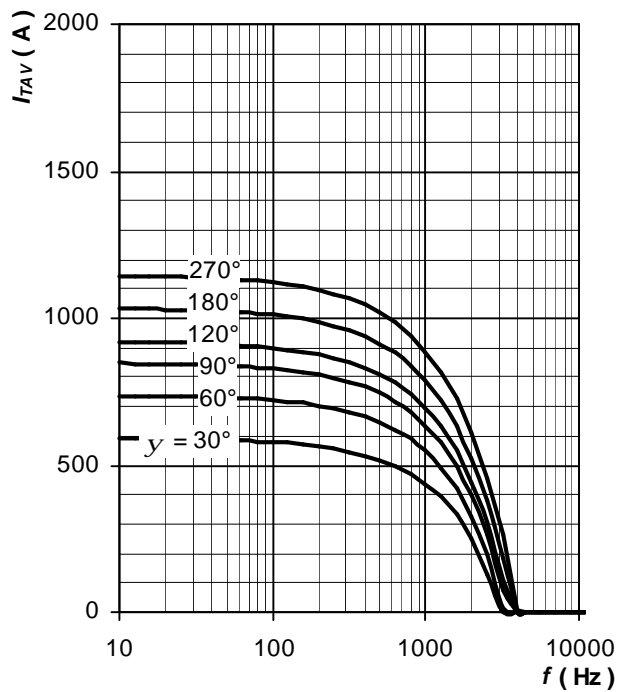


Fig. 29 Average on-state current vs. frequency, trapezoid waveform,  $T_C = 90^\circ\text{C}$ ,  $di_T/dt = \pm 100\text{ A}/\mu\text{s}$ ,  $V_R = 100\text{ V}$

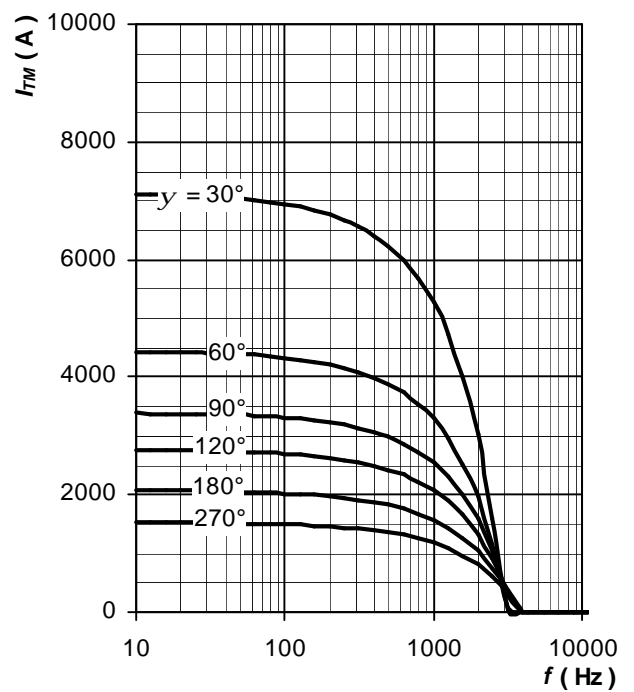


Fig. 30 Maximum on-state current vs. frequency, trapezoid waveform,  $T_C = 90^\circ\text{C}$ ,  $di_T/dt = \pm 100\text{ A}/\mu\text{s}$ ,  $V_R = 100\text{ V}$

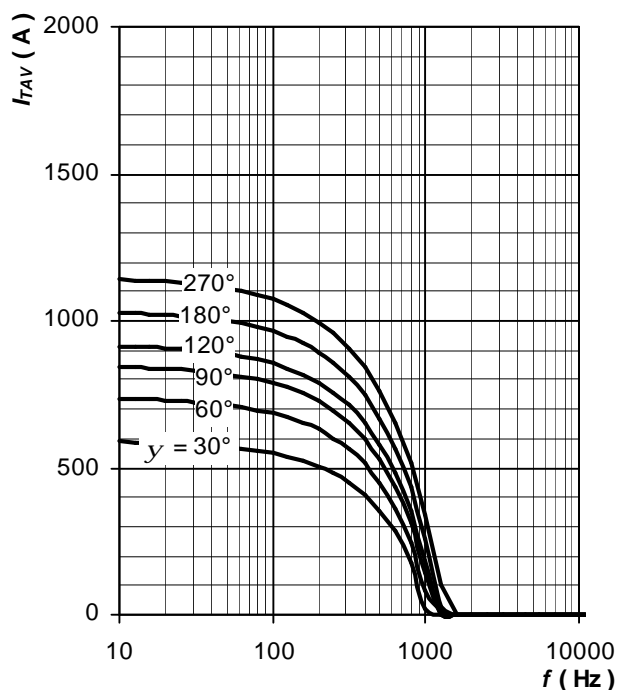


Fig. 31 Average on-state current vs. frequency, trapezoid waveform,  $T_C = 90^\circ\text{C}$ ,  $di_T/dt = \pm 100\text{ A}/\mu\text{s}$ ,  $V_R = 2/3 V_{DRM}$

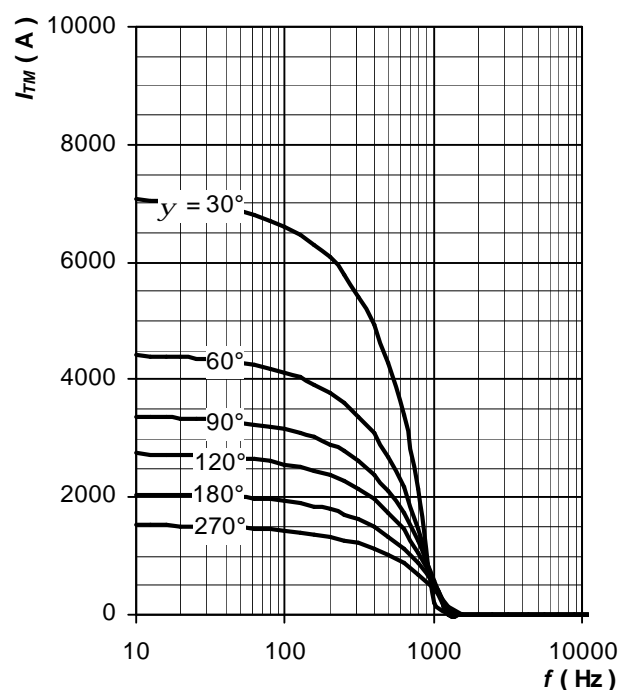


Fig. 32 Maximum on-state current vs. frequency, trapezoid waveform,  $T_C = 90^\circ\text{C}$ ,  $di_T/dt = \pm 100\text{ A}/\mu\text{s}$ ,  $V_R = 2/3 V_{DRM}$

ABB s.r.o., Novodvorska 1768/138a, 142 21 Praha 4, Czech Republic

ABB s.r.o. reserves the right to change the data contained herein at any time without notice

**Frequency Ratings**

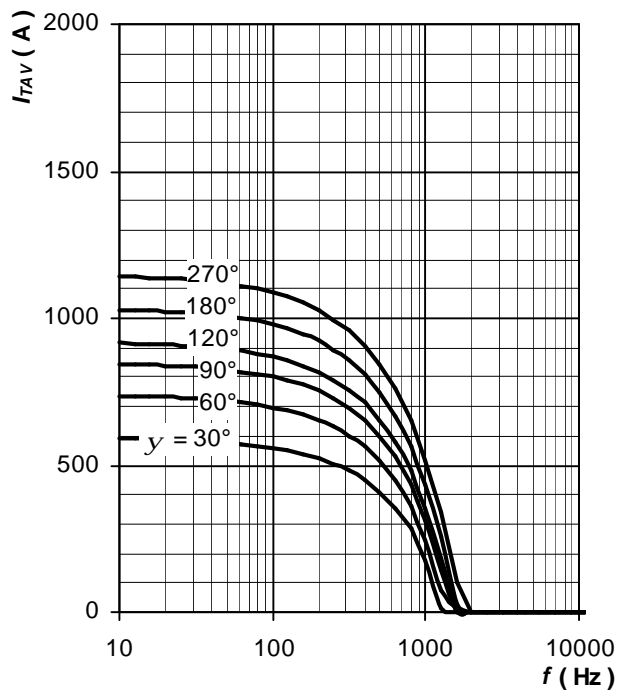


Fig. 33 Average on-state current vs. frequency, trapezoid waveform,  $T_C = 90^\circ\text{C}$ ,  $di_T/dt = \pm 500\text{ A}/\mu\text{s}$ ,  $V_R = 100\text{ V}$

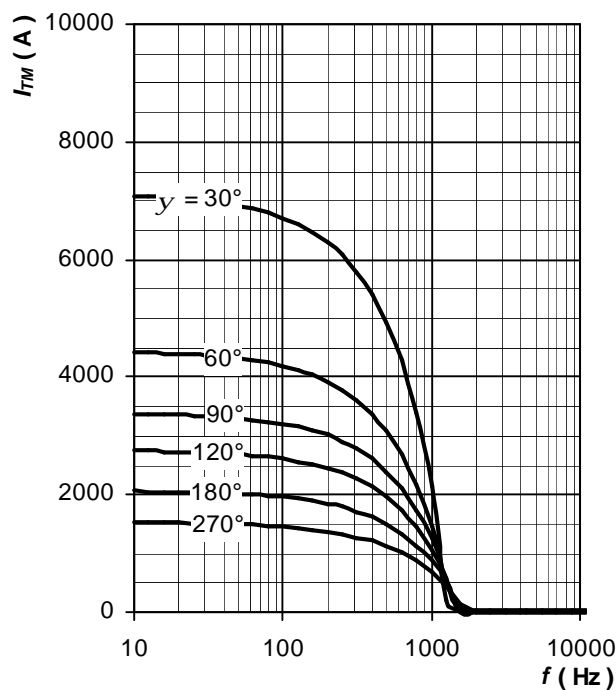


Fig. 34 Maximum on-state current vs. frequency, trapezoid waveform,  $T_C = 90^\circ\text{C}$ ,  $di_T/dt = \pm 500\text{ A}/\mu\text{s}$ ,  $V_R = 100\text{ V}$

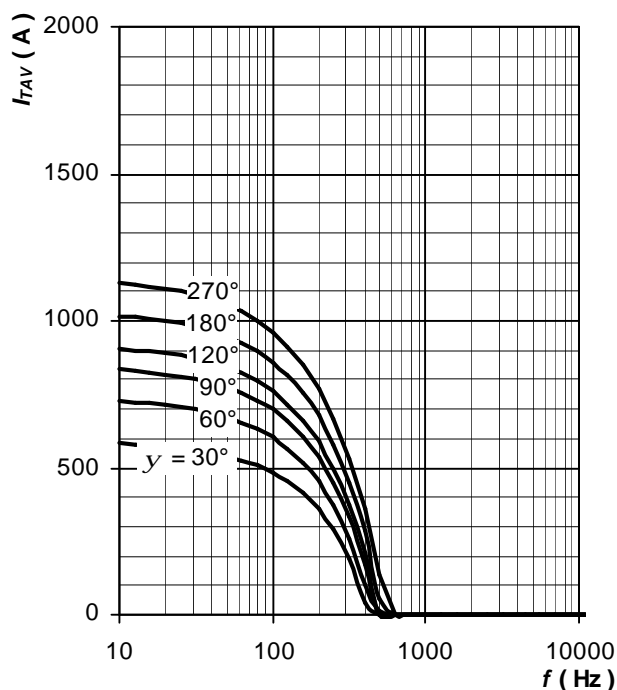


Fig. 35 Average on-state current vs. frequency, trapezoid waveform,  $T_C = 90^\circ\text{C}$ ,  $di_T/dt = \pm 500\text{ A}/\mu\text{s}$ ,  $V_R = 2/3 V_{DRM}$

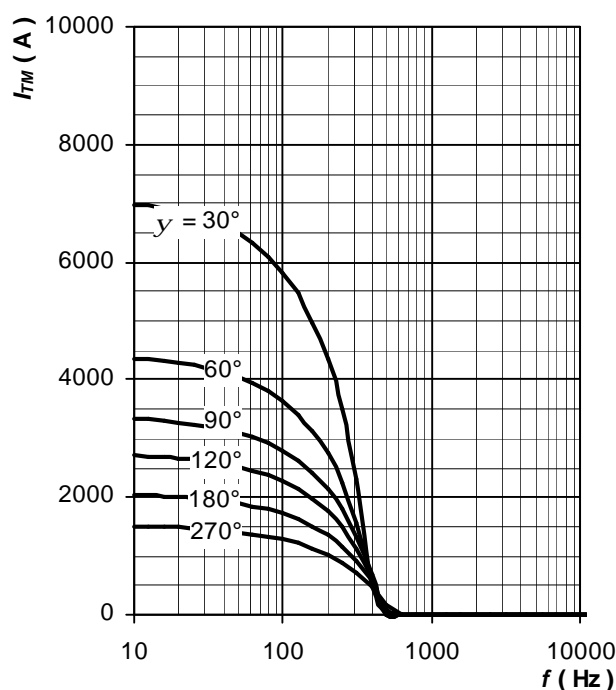


Fig. 36 Maximum on-state current vs. frequency, trapezoid waveform,  $T_C = 90^\circ\text{C}$ ,  $di_T/dt = \pm 500\text{ A}/\mu\text{s}$ ,  $V_R = 2/3 V_{DRM}$

ABB s.r.o., Novodvorska 1768/138a, 142 21 Praha 4, Czech Republic

ABB s.r.o. reserves the right to change the data contained herein at any time without notice

Notes:

ABB s.r.o., Novodvorska 1768/138a, 142 21 Praha 4, Czech Republic

ABB s.r.o. reserves the right to change the data contained herein at any time without notice