

V_{DSM}	=	4200 V
I_{TAVM}	=	1150 A
I_{TRMS}	=	1800 A
I_{TSM}	=	15000 A
V_{T0}	=	0.95 V
r_T	=	0.575 mW

Phase Control Thyristor

5STP 12F4200

Doc. No. 5SYA1021-03 Aug.00

- Patented free-floating silicon technology
- Low on-state and switching losses
- Designed for traction, energy and industrial applications
- Optimum power handling capability

Blocking

Part Number	5STP 12F4200	5STP 12F4000	5STP 12F3600	Conditions
V_{DRM} V_{RRM}	4200 V	4000 V	3600 V	$f = 50$ Hz, $t_p = 10$ ms
V_{RSM1}	4600 V	4400 V	4000 V	$t_p = 5$ ms, single pulse
I_{DRM}	≤ 200 mA			V_{DRM}
I_{RRM}	≤ 200 mA			V_{RRM}
dV/dt_{crit}	1000 V/ μ s			@ Exp. to $0.67 \times V_{DRM}$
$T_j = 125^\circ\text{C}$				

Mechanical data

F_M	Mounting force	nom.	22 kN
		min.	14 kN
		max.	24 kN
a	Acceleration		
	Device unclamped		50 m/s ²
	Device clamped		100 m/s ²
m	Weight		0.6 kg
D_S	Surface creepage distance		25 mm
D_a	Air strike distance		14 mm



ABB Semiconductors AG reserves the right to change specifications without notice.

On-state

I_{TAVM}	Max. average on-state current	1150 A	Half sine wave, $T_C = 70^\circ\text{C}$	
I_{TRMS}	Max. RMS on-state current	1800 A		
I_{TSM}	Max. peak non-repetitive surge current	15000 A	$t_p = 10 \text{ ms}$	$T_j = 125^\circ\text{C}$ After surge: $V_D = V_R = 0\text{V}$
		16000 A	$t_p = 8.3 \text{ ms}$	
I^2t	Limiting load integral	1125 kA^2s	$t_p = 10 \text{ ms}$	
		1062 kA^2s	$t_p = 8.3 \text{ ms}$	
V_T	On-state voltage	2.10 V	$I_T = 2000 \text{ A}$	$T_j = 125^\circ\text{C}$
V_{T0}	Threshold voltage	0.95 V	$I_T = 600 - 1800 \text{ A}$	
r_T	Slope resistance	0.575 $\text{m}\Omega$		
I_H	Holding current	30-80 mA	$T_j = 25^\circ\text{C}$	
		15-60 mA	$T_j = 125^\circ\text{C}$	
I_L	Latching current	100-500 mA	$T_j = 25^\circ\text{C}$	
		50-200 mA	$T_j = 125^\circ\text{C}$	

Switching

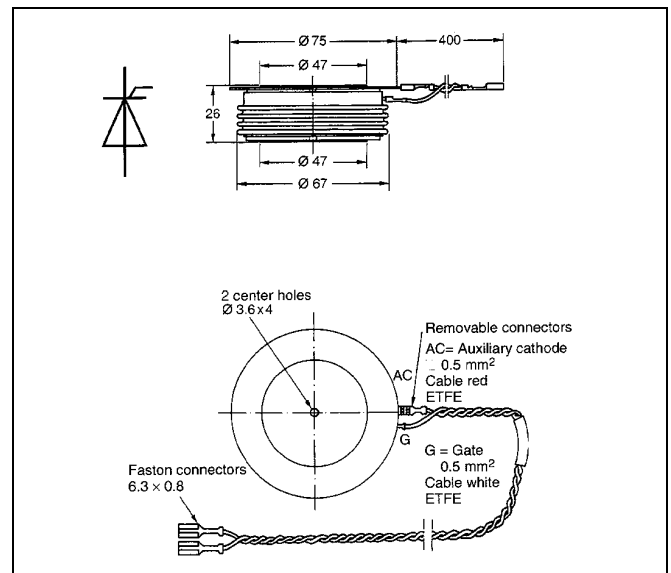
di/dt_{crit}	Critical rate of rise of on-state current	100 $\text{A}/\mu\text{s}$	Cont.	$V_D \leq 0.67 \cdot V_{DRM}$ $T_j = 125^\circ\text{C}$ $I_{TRM} = 2000 \text{ A}$ $f = 50 \text{ Hz}$ $I_{FG} = 2.0 \text{ A}$ $t_r = 0.5 \mu\text{s}$
		200 $\text{A}/\mu\text{s}$	60 sec.	
t_d	Delay time	$\leq 2.0 \mu\text{s}$	$V_D = 0.4 \cdot V_{DRM}$	$I_{FG} = 2.0 \text{ A}$ $t_r = 0.5 \mu\text{s}$
t_q	Turn-off time	$\leq 600 \mu\text{s}$	$V_D \leq 0.67 \cdot V_{DRM}$ $dv_D/dt = 20\text{V}/\mu\text{s}$	$I_{TRM} = 2000 \text{ A}$ $T_j = 125^\circ\text{C}$ $V_R > 200 \text{ V}$
Q_{rr}	Recovery charge	min	2500 μAs	$di_T/dt = -5 \text{ A}/\mu\text{s}$
		max	4000 μAs	

Triggering

V_{GT}	Gate trigger voltage	2.6 V	$T_j = 25^\circ\text{C}$
I_{GT}	Gate trigger current	400 mA	$T_j = 25^\circ\text{C}$
V_{GD}	Gate non-trigger voltage	0.3 V	$V_D = 0.4 \cdot V_{DRM}$
I_{GD}	Gate non-trigger current	10 mA	$V_D = 0.4 \cdot V_{DRM}$
V_{FGM}	Peak forward gate voltage	12 V	
I_{FGM}	Peak forward gate current	10 A	
V_{RGM}	Peak reverse gate voltage	10 V	
P_G	Maximum gate power loss	3 W	

Thermal

$T_{j\max}$	Max. junction temperature	125°C	
$T_{j\text{stg}}$	Storage temperature range	-40...150°C	
R_{thJC}	Thermal resistance junction to case	33 K/kW	Anode side cooled
		35 K/kW	Cathode side cooled
		17 K/kW	Double side cooled
R_{thCH}	Thermal resistance case to heat sink	8 K/kW	Single side cooled
		4 K/kW	Double side cooled

Analytical function for transient thermal impedance:

$$Z_{\text{thJC}}(t) = \sum_{i=1}^n R_i(1 - e^{-t/\tau_i})$$

i	1	2	3	4
R_i (K/kW)	10.35	3.76	2.29	0.67
τ_i (s)	0.3723	0.0525	0.0057	0.0023

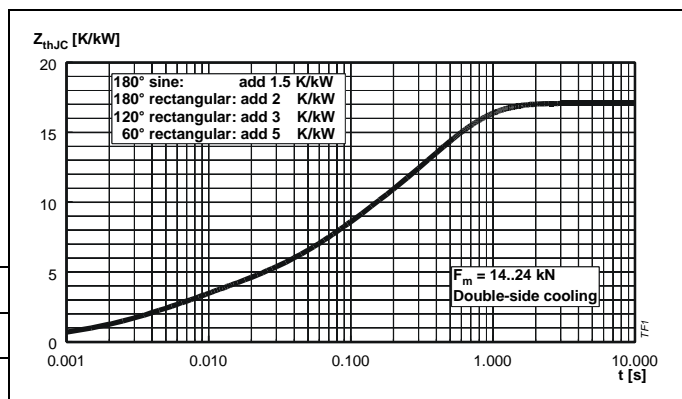

Fig. 1 Transient thermal impedance junction to case.

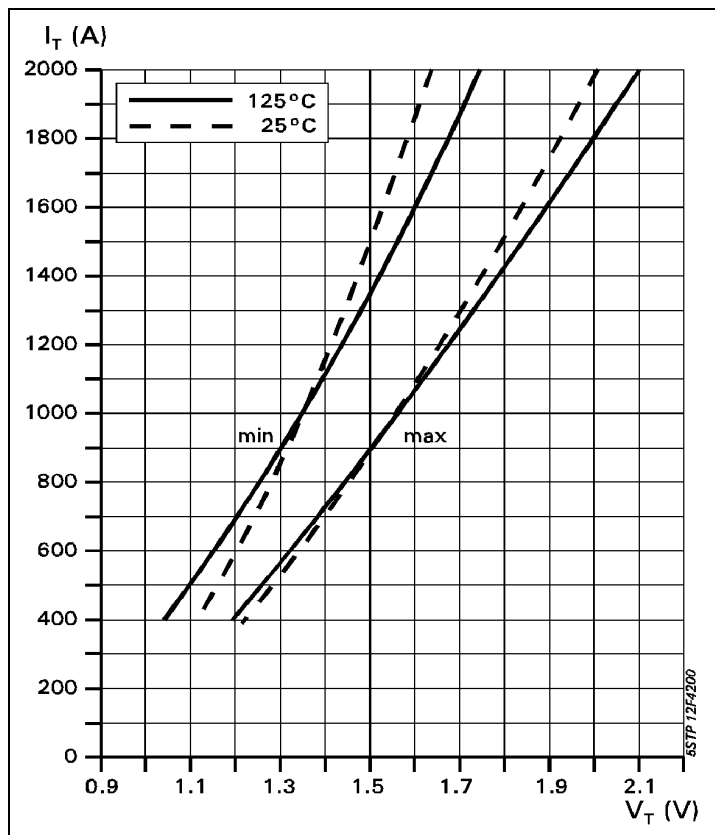

Fig. 2. On-state characteristics.

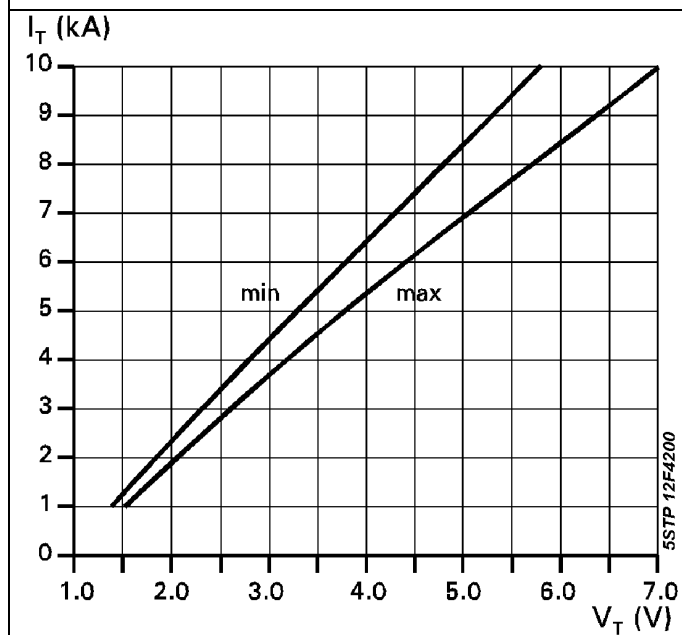

Fig. 3 On state characteristics.

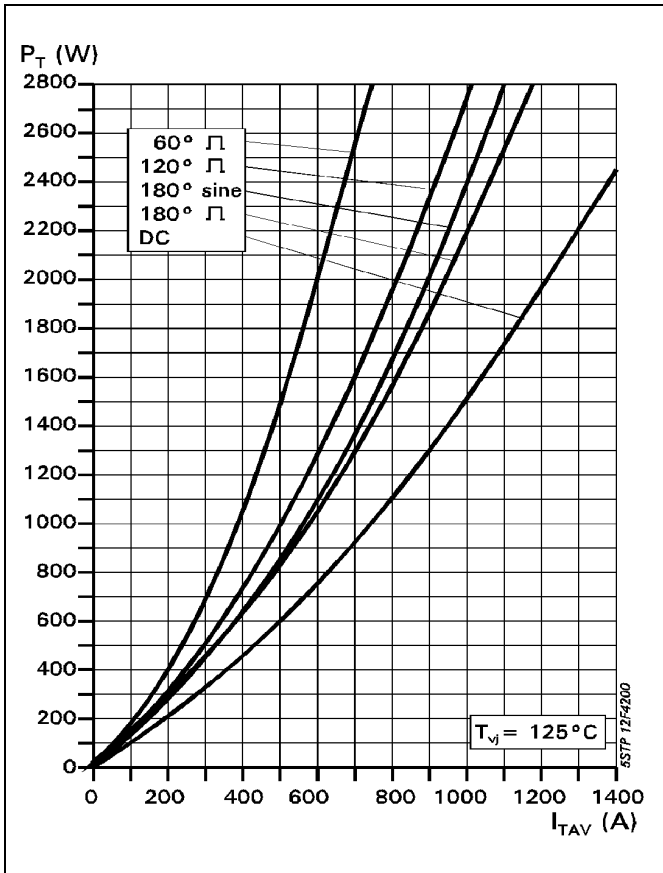

Fig. 4 On-state power dissipation vs. mean on-state current. Turn-on losses excluded.

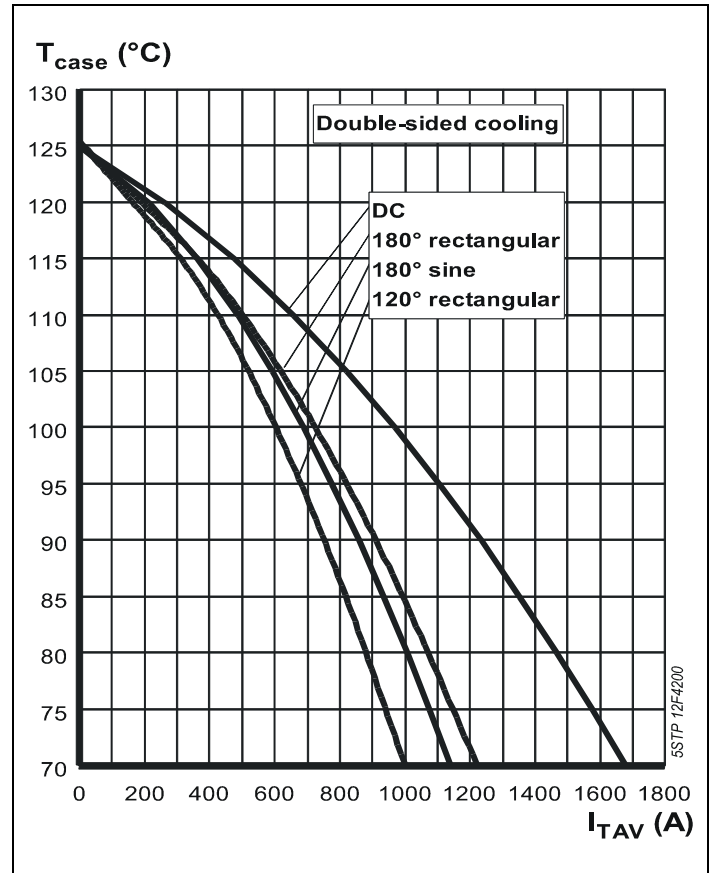

Fig. 5 Max. permissible case temperature vs. mean on-state current.

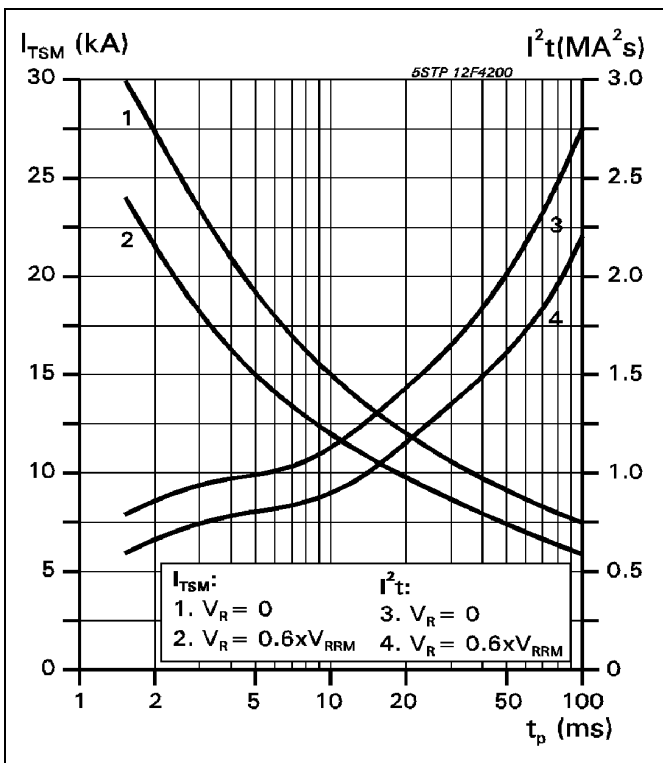

Fig. 6 Surge on-state current vs. pulse length. Half-sine wave.

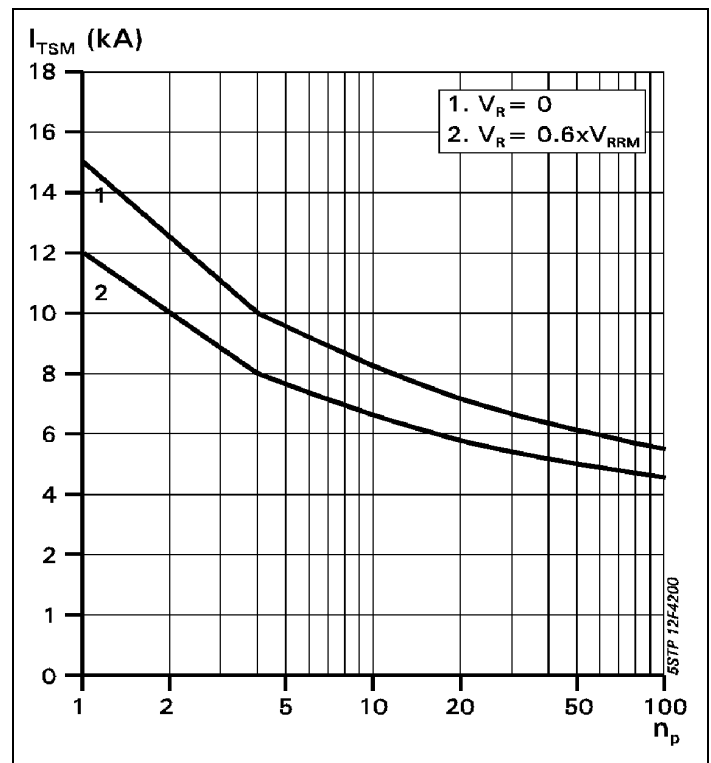

Fig. 7 Surge on-state current vs. number of pulses. Half-sine wave, 10 ms, 50Hz.

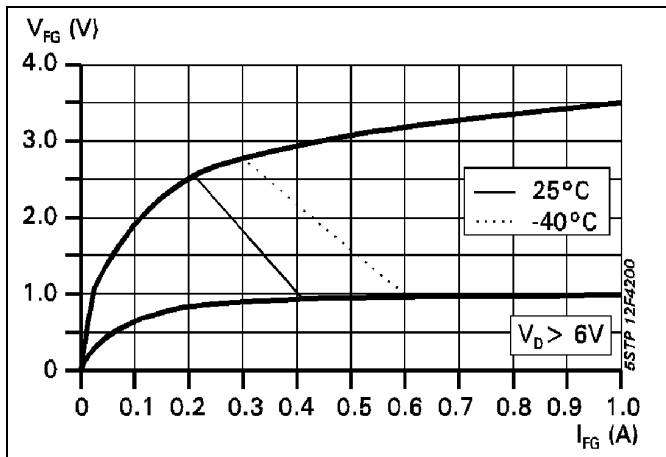

Fig. 8 Gate trigger characteristics.

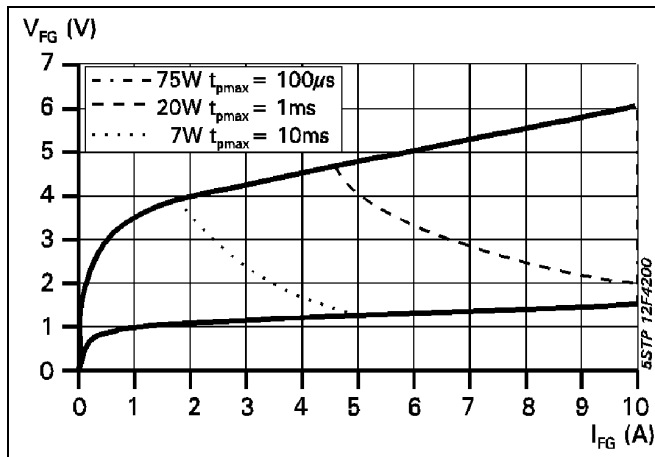

Fig. 9 Max. peak gate power loss.

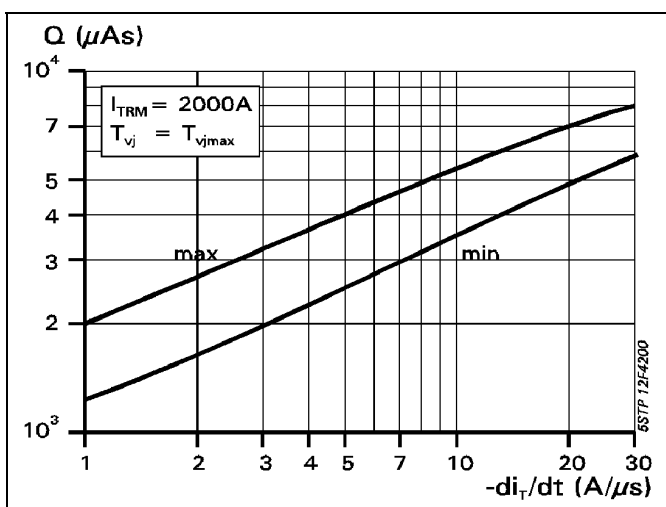

Fig. 10 Recovery charge vs. decay rate of on-state current.

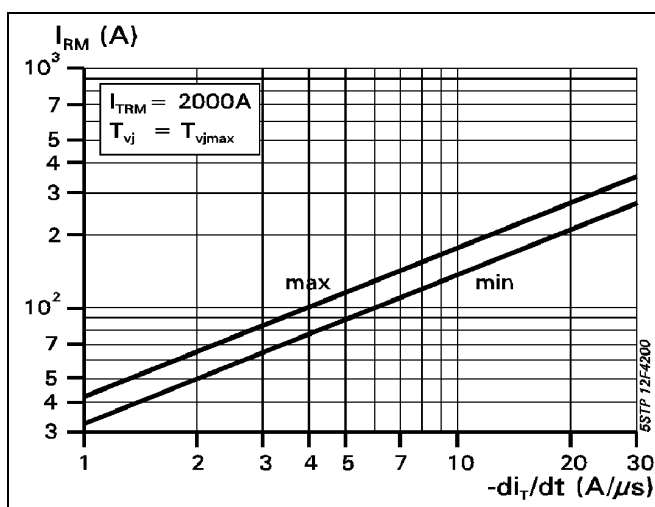

Fig. 11 Peak reverse recovery current vs. decay rate of on-state current.

ABB Semiconductors AG reserves the right to change specifications without notice.



ABB Semiconductors AG
 Fabrikstrasse 3
 CH-5600 Lenzburg, Switzerland

Telephone +41 62 888 6419
 Fax +41 62 888 6306
 E-mail info@ch.abb.com
 Internet www.abbsem.com