

# 5STP 18F1810

## Phase control thyristor



- Patented free-floating silicon technology
- Low on-state losses
- Designed for energy and industrial applications
- Optimum power handling capability

### Applications

- Controlled line frequency bridge arm
- AC motor soft starters
- DC motor drives

### Key parameters

- $V_{DRM}, V_{RRM} = 1800 \text{ V}$
- $I_{TAVm} = 1\,780 \text{ A}$
- $I_{TSM} = 21\,000 \text{ A}$
- $V_{TO} = 0.923 \text{ V}$
- $r_T = 0.188 \text{ m}\Omega$

Types	
	$V_{DRM}, V_{RRM}$
5STP 18F1810	1 800 V
Conditions	$T_i = -40 \div 125 \text{ }^\circ\text{C}$ , half sine waveform, $f = 50 \text{ Hz}$ , note 1

Mechanical data			
$F_m$	Mounting force	$22 \pm 2$	kN
$m$	Weight	0.45	kg
$a$	Acceleration resistance	50	$\text{m/s}^2$
$D_s$	Surface creepage distance	25	mm
$D_a$	Air strike distance	14	mm

Fig. 1 Case

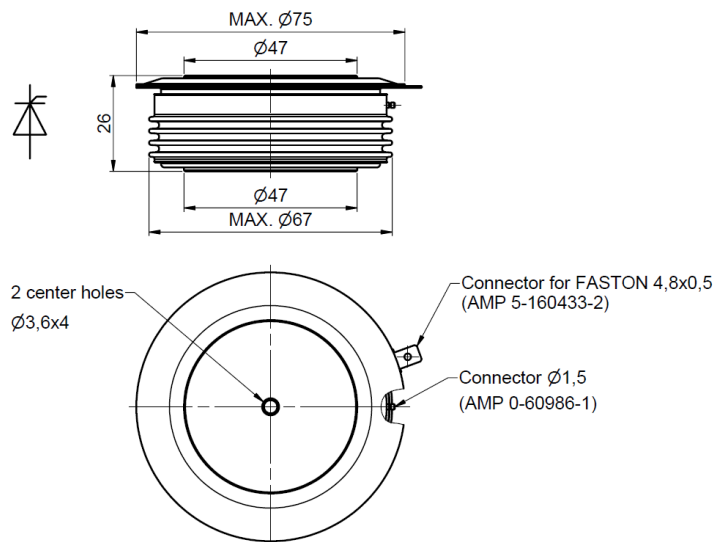

Maximum ratings		Maximum limits	Unit
$V_{DRM}, V_{RRM}$	<b>Repetitive peak reverse and off-state voltage</b> $T_j = -40 \div 125 \text{ }^\circ\text{C}$ , note 1	<b>1800</b>	V
$I_{DM}$	<b>Peak off-state current</b> $V_D = V_{DRM}$	<b>200</b>	mA
$I_{RM}$	<b>Peak reverse current</b> $V_R = V_{RRM}$	<b>200</b>	mA
$I_{TAVm}$	<b>Average on-state current</b> half sine waveform, $f = 50 \text{ Hz}$	$T_c = 70 \text{ }^\circ\text{C}$ <b>1780</b>	A
$I_{TRMS}$	<b>RMS on-state current</b> half sine waveform, $f = 50 \text{ Hz}$	$T_c = 70 \text{ }^\circ\text{C}$ <b>2790</b>	A
$I_{TSM}$	<b>Non repetitive peak surge current</b> half sine pulse, $V_D = V_R = 0 \text{ V}$	$t_p = 8.3 \text{ ms}$ <b>22,400</b>	A
		$t_p = 10 \text{ ms}$ <b>21,000</b>	
$I^2t$	<b>Limiting load integral</b> half sine pulse, $V_D = V_R = 0 \text{ V}$	$t_p = 8.3 \text{ ms}$ <b>2 080,000</b>	A <sup>2</sup> s
		$t_p = 10 \text{ ms}$ <b>2 205,000</b>	
$(di_T/dt)_{cr}$	<b>Critical rate of rise of on-state current</b> $I_T = I_{TAVm}$ , half sine waveform, $V_D = 2/3 V_{DRM}$ , $t_r = 0.3 \text{ } \mu\text{s}$ , $I_{GT} = 2 \text{ A}$	$f = 50 \text{ Hz}$ <b>200</b>	A/ $\mu\text{s}$
		$f = 1 \text{ Hz}$ <b>1000</b>	
$(dv_D/dt)_{cr}$	<b>Critical rate of rise of off-state voltage</b> $V_D = 2/3 V_{DRM}$	<b>1000</b>	V/ $\mu\text{s}$
$P_{GAVm}$	<b>Maximum average gate power losses</b>	<b>3</b>	W
$I_{FGM}$	<b>Peak gate current</b>	<b>10</b>	A
$V_{FGM}$	<b>Peak gate voltage</b>	<b>12</b>	V
$V_{RGM}$	<b>Reverse peak gate voltage</b>	<b>10</b>	V
$T_{jmin} - T_{jmax}$	<b>Operating temperature range</b>	<b>-40 <math>\div</math> 125</b>	$^\circ\text{C}$
$T_{STG}$	<b>Storage temperature range</b>	<b>-40 <math>\div</math> 140</b>	

Unless otherwise specified  $T_j = 125 \text{ }^\circ\text{C}$

Note 1: De-rating factor of 0.13% VRRM or VDRM per  $^\circ\text{C}$  is applicable for  $T_j$  below  $25 \text{ }^\circ\text{C}$

STATUS	SECURITY LEVEL	DOCUMENT ID	REV.	LANG.	PAGE
Preliminary datasheet	Public	5STP 18F1810, TS - T/343/21 Jun-21	A	en	2/7

On-state characteristics		Value			Unit
		min	typ	max	
$V_{T0}$	Threshold voltage			0.923	V
$r_T$	Slope resistance $I_{T1} = 1000 \text{ A}, I_{T2} = 3000 \text{ A}$			0.188	m $\Omega$
$V_{TM}$	Maximum peak on-state voltage $I_{TM} = 2000 \text{ A}$			1.300	V

Unless otherwise specified  $T_j = 125 \text{ }^\circ\text{C}$

#### On-state characteristics model

Analytical function for maximum on-state characteristic	$T_{vi}$	A	B	C	D
$V_T = A + B \cdot I_T + C \cdot \ln(I_T + 1) + D \cdot \sqrt{I_T}$	25 $^\circ\text{C}$	$85.83 \cdot 10^{-3}$	$54.12 \cdot 10^{-6}$	$139.9 \cdot 10^{-3}$	$2.254 \cdot 10^{-3}$
	125 $^\circ\text{C}$	$195.3 \cdot 10^{-3}$	$115.4 \cdot 10^{-6}$	$107.9 \cdot 10^{-3}$	$1.183 \cdot 10^{-3}$

Characteristics		Value			Unit
		min	typ	max	
$t_{gd}$	Delay time $T_j = 25 \text{ }^\circ\text{C}, V_D = 0.4 V_{DRM}, I_{TM} = I_{TAVM},$ $t_r = 0.3 \text{ } \mu\text{s}, I_{GT} = 2 \text{ A}$			3.0	$\mu\text{s}$
$t_q$	Turn-off time $I_T = 2000 \text{ A}, di_T/dt = -1.5 \text{ A}/\mu\text{s},$ $V_R = 200 \text{ V}, V_D = 2/3 V_{DRM}, dv_D/dt = 20 \text{ V}/\mu\text{s}$			100	$\mu\text{s}$
$Q_{rr}$	Recovered charge the same conditions as at $t_q$			1400	$\mu\text{C}$
$I_{rrM}$	Reverse recovery maximum current the same conditions as at $t_q$			50	A
$I_H$	Holding current	$T_j = 25 \text{ }^\circ\text{C}$		150	mA
		$T_j = 125 \text{ }^\circ\text{C}$		130	
$I_L$	Latching current	$T_j = 25 \text{ }^\circ\text{C}$		600	mA
		$T_j = 125 \text{ }^\circ\text{C}$		370	
$V_{GT}$	Gate trigger voltage $V_D = 12 \text{ V}, I_T = 4 \text{ A}$	$T_j = -40 \text{ }^\circ\text{C}$		4	V
		$T_j = 25 \text{ }^\circ\text{C}$		3	
		$T_j = 125 \text{ }^\circ\text{C}$	0.25	2	
$I_{GT}$	Gate trigger current $V_D = 12 \text{ V}, I_T = 4 \text{ A}$	$T_j = -40 \text{ }^\circ\text{C}$		1000	mA
		$T_j = 25 \text{ }^\circ\text{C}$		500	
		$T_j = 125 \text{ }^\circ\text{C}$	10	300	

Unless otherwise specified  $T_j = 125 \text{ }^\circ\text{C}$

STATUS	SECURITY LEVEL	DOCUMENT ID	REV.	LANG.	PAGE
Preliminary datasheet	Public	5STP 18F1810, TS - T/343/21 Jun-21	A	en	3/7

Thermal parameters			Value	Unit
$R_{thjc}$	Thermal resistance junction to case	double side cooling	17.0	K/kW
		anode side cooling	33.0	
		cathode side cooling	35.0	
$R_{thch}$	Thermal resistance case to heatsink	double side cooling	4.0	K/kW
		single side cooling	8.0	

### Transient thermal impedance

#### Analytical function for transient thermal impedance

$$Z_{thjc} = \sum_{i=1}^4 R_i (1 - \exp(-t/\tau_i))$$

i	1	2	3	4
$\tau_i$ (s)	0.4413	0.0425	0.0026	0.0003
$R_i$ (K/kW)	10.082	4.659	2.167	0.091

Fig. 2 Dependence transient thermal impedance junction to case on square pulse

#### Correction for periodic waveforms

180°	sine	1.5	K/kW
180°	rectangular	2.0	K/kW
120°	rectangular	3.0	K/kW
60°	rectangular	5.0	K/kW

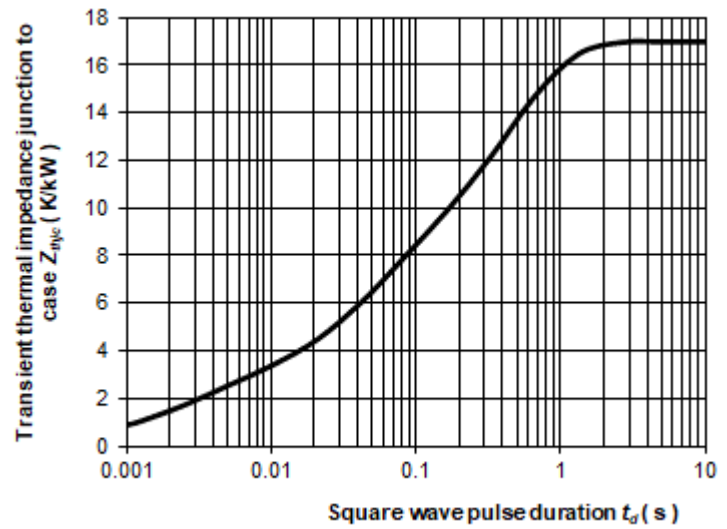

STATUS Preliminary datasheet	SECURITY LEVEL Public	DOCUMENT ID 5STP 18F1810, TS - T/343/21 Jun-21	REV. A	LANG. en	PAGE 4/7
---------------------------------	--------------------------	---	-----------	-------------	-------------

## On-state and surge characteristics

Fig. 3 Maximum on-state characteristics

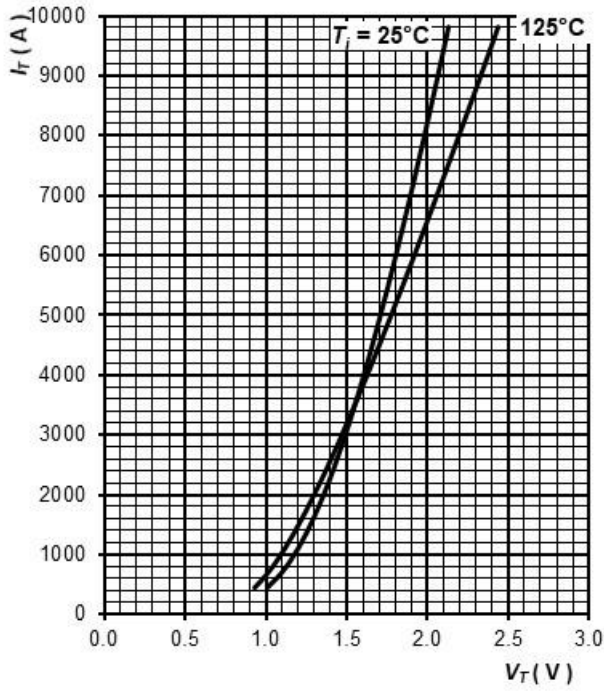
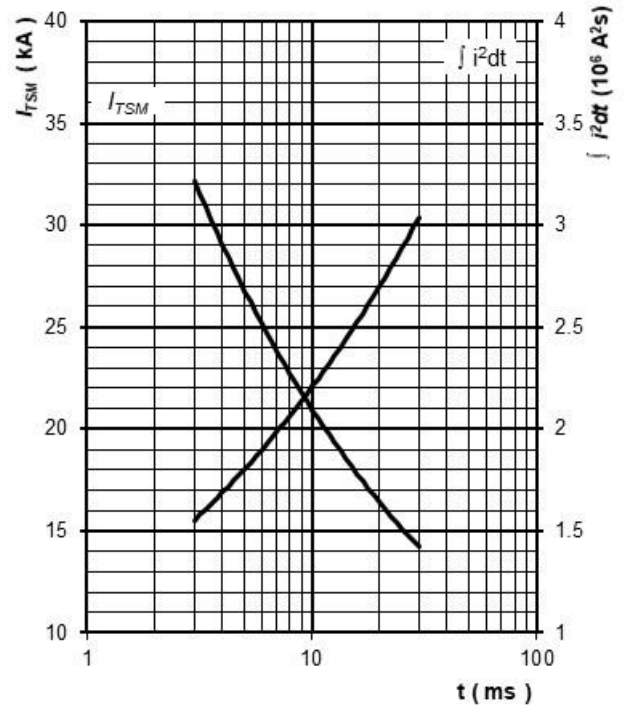

Fig. 4 Surge on-state current vs. pulse length, half sine wave, single pulse,  $V_D = V_R = 0$  V,  $T_j = T_{j,max}$



## Gate trigger characteristics

Fig. 5 Gate trigger characteristics

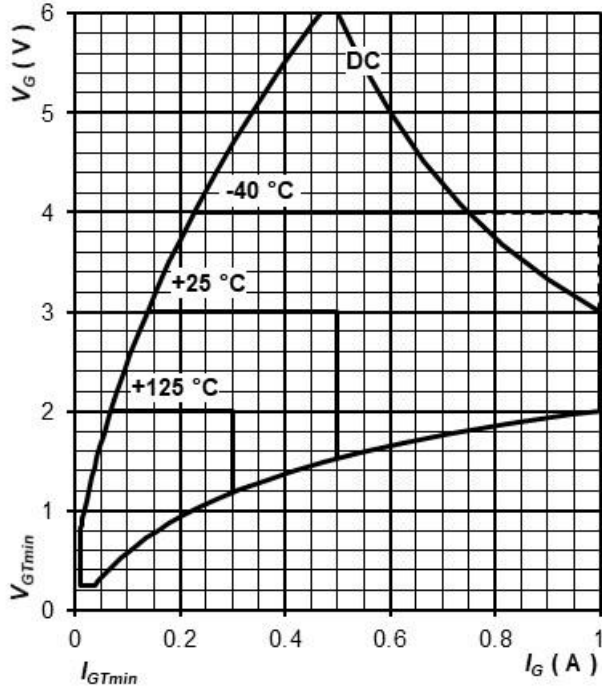
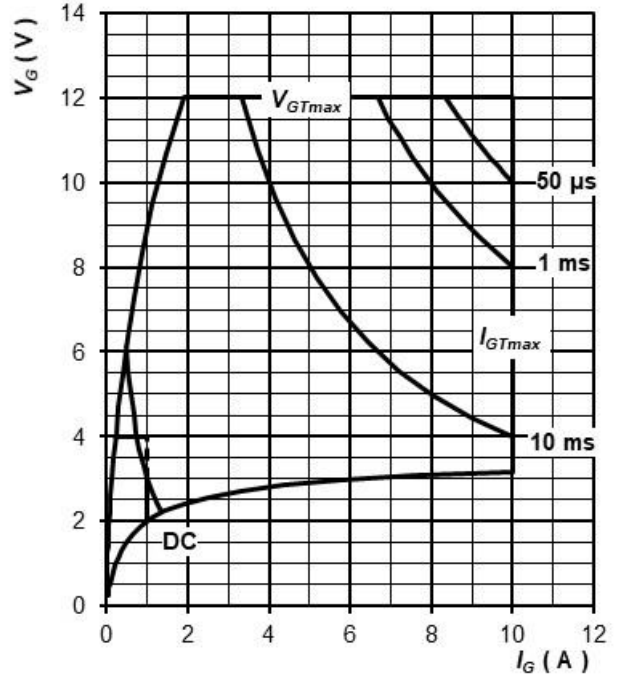

Fig. 6 Maximum peak gate power loss



STATUS	SECURITY LEVEL	DOCUMENT ID	REV.	LANG.	PAGE
Preliminary datasheet	Public	5STP 18F1810, TS - T/343/21 Jun-21	A	en	5/7

## Power loss and maximum case temperature characteristics

Fig. 7 On-state power loss vs. average on-state current, sine waveform,  $f = 50 \text{ Hz}$ ,  $T = 1/f$

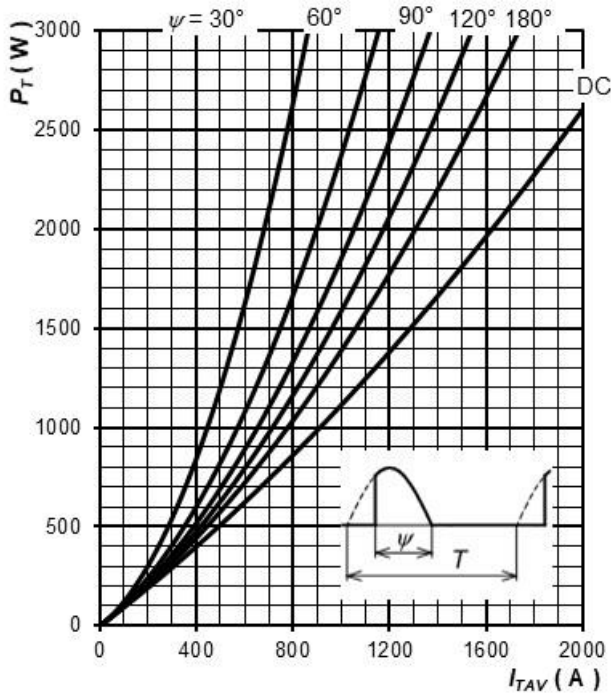

Fig. 8 On-state power loss vs. average on-state current, square waveform,  $f = 50 \text{ Hz}$ ,  $T = 1/f$

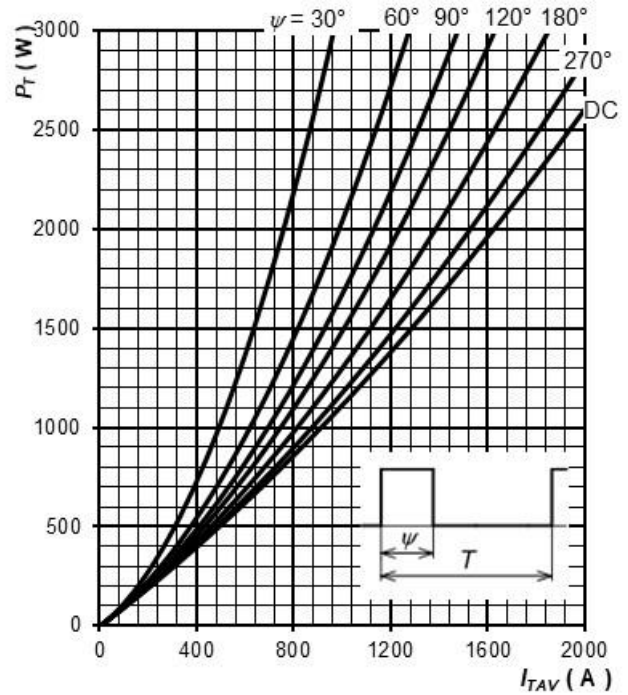

Fig. 9 Max. case temperature vs. aver. on-state current, sine waveform,  $f = 50 \text{ Hz}$ ,  $T = 1/f$

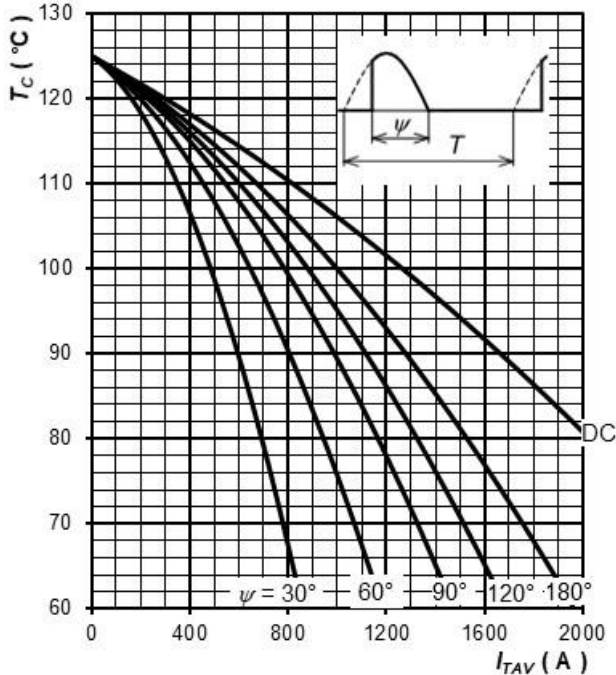
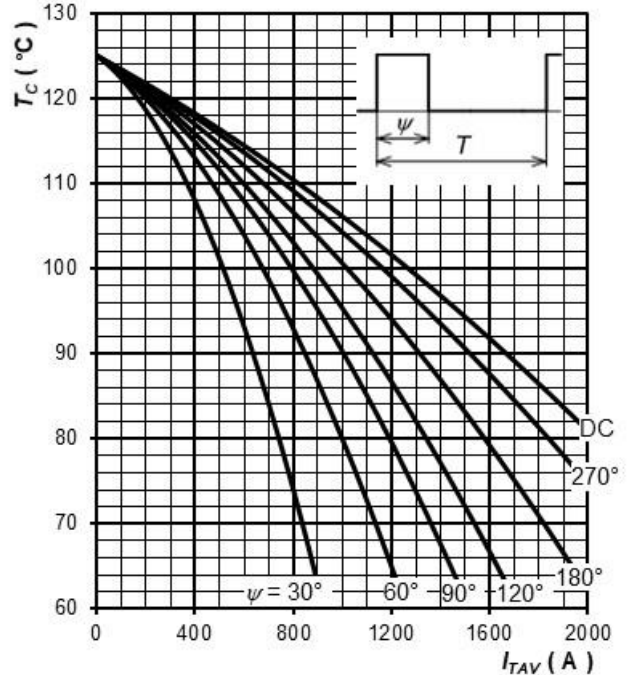

Fig. 10 Max. case temperature vs. aver. on-state current, square waveform,  $f = 50 \text{ Hz}$ ,  $T = 1/f$



**Note 2:** Figures number 7 + 10 have been calculated without considering any turn-on and turn-off losses. They are valid for  $f = 50$  or  $60 \text{ Hz}$  operation.

STATUS	SECURITY LEVEL	DOCUMENT ID	REV.	LANG.	PAGE
Preliminary datasheet	Public	5STP 18F1810, TS - T/343/21 Jun-21	A	en	6/7

**ABB Power Grids Czech Republic s.r.o.**

A Hitachi ABB Joint Venture  
Semiconductors  
Novodvorska 1768/138a  
142 21 Praha 4  
Czech Republic

[hitachiabb-powergrids.com/semiconductors](http://hitachiabb-powergrids.com/semiconductors)

**Note**

We reserve all rights in this document and in the information contained therein. Reproduction use or disclosure to third parties without expressed authority is strictly forbidden. © 2021 Hitachi Power Grids. All rights reserved.

STATUS	SECURITY LEVEL	DOCUMENT ID	REV.	LANG.	PAGE
Preliminary datasheet	Public	5STP 18F1810, TS - T/343/21 Jun-21	A	en	7/7