

V_{DRM}	=	8500 V
$I_{T(AV)M}$	=	4450 A
$I_{T(RMS)}$	=	6990 A
I_{TSM}	=	$90.0 \cdot 10^3$ A
V_{T0}	=	1.06 V
r_T	=	0.168 m Ω

Phase Control Thyristor

5STP 45Y8500

Doc. No. 5SYA1079-05 Mar. 21

- Patented free-floating silicon technology
- Low on-state and switching losses
- Designed for traction, energy and industrial applications
- Optimum power handling capability
- Interdigitated amplifying gate
- Custom irradiation variant available on request

Blocking

Maximum rated values ¹⁾

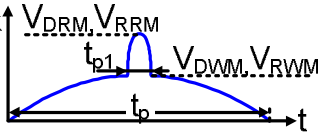
Parameter	Symbol	Conditions	5STP 45Y8500	Unit
Max. surge peak forward and reverse blocking voltage	V_{DSM} , V_{RSM}	$t_p = 10$ ms, $f = 5$ Hz $T_{vj} = 25 \dots 110$ °C, Note 1	8500	V
Max repetitive peak forward and reverse blocking voltage	V_{DRM} , V_{RRM}	$f = 50$ Hz, $t_p = 10$ ms, $t_{p1} = 250$ μ s, $T_{vj} = 25 \dots 110$ °C, Note 1, Note 2	8500	V
Max crest working forward and reverse voltages	V_{DWM} , V_{RWM}		5670	V
Critical rate of rise of commutating voltage	dv/dt_{crit}	Exp. to $0.67 \cdot V_{DRM}$, $T_{vj} = 110$ °C	2000	V/ μ s

Characteristic values

Parameter	Symbol	Conditions	min	typ	max	Unit
Forward leakage current	I_{DRM}	V_{DRM} , $T_{vj} = 110$ °C			2000	mA
Reverse leakage current	I_{RRM}	V_{RRM} , $T_{vj} = 110$ °C			2000	mA

Note 1: Voltage de-rating factor of 0.11% per °C is applicable for T_{vj} below +25 °C.

Note 2: Recommended minimum ratio of V_{DRM} / V_{DWM} or $V_{RRM} / V_{RWM} = 2$. See App. Note 5SYA 2051.

Mechanical data

Maximum rated values ¹⁾

Parameter	Symbol	Conditions	min	typ	max	Unit
Mounting force	F_M		170	190	210	kN
Acceleration	a	Device unclamped			50	m/s ²
Acceleration	a	Device clamped			100	m/s ²

Characteristic values

Parameter	Symbol	Conditions	min	typ	max	Unit
Weight	m				5.14	kg
Housing thickness	H	$F_M = 190$ kN, $T_a = 25$ °C	34.94		35.39	mm
Surface creepage distance	D_s		56			mm
Air strike distance	D_a		22			mm

1) Maximum rated values indicate limits beyond which damage to the device may occur

On-state

Maximum rated values ¹⁾

Parameter	Symbol	Conditions	min	typ	max	Unit
Average on-state current	$I_{T(AV)M}$	Half sine wave, $T_c = 70\text{ °C}$			4450	A
RMS on-state current	$I_{T(RMS)}$				6990	A
Peak non-repetitive surge current	I_{TSM}	$t_p = 10\text{ ms}$, $T_{vj} = 110\text{ °C}$, sine half wave,			$90.0 \cdot 10^3$	A
Limiting load integral	I^2t	$V_D = V_R = 0\text{ V}$, after surge			$40.5 \cdot 10^6$	A ² s
Peak non-repetitive surge current	I_{TSM}	$t_p = 10\text{ ms}$, $T_{vj} = 110\text{ °C}$, sine half wave,			$70.8 \cdot 10^3$	A
Limiting load integral	I^2t	$V_R = 0.6 \cdot V_{RRM}$, after surge			$25.1 \cdot 10^6$	A ² s

Characteristic values

Parameter	Symbol	Conditions	min	typ	max	Unit
On-state voltage	V_T	$I_T = 5000\text{ A}$, $T_{vj} = 110\text{ °C}$		1.78	1.90	V
Threshold voltage	$V_{(T0)}$	$I_T = 2000\text{ A} - 6000\text{ A}$, $T_{vj} = 110\text{ °C}$		1.01	1.06	V
Slope resistance	r_T				0.155	0.168
Holding current	I_H	$T_{vj} = 25\text{ °C}$			150	mA
		$T_{vj} = 110\text{ °C}$			100	mA
Latching current	I_L	$T_{vj} = 25\text{ °C}$			1500	mA
		$T_{vj} = 110\text{ °C}$			1000	mA

Switching

Maximum rated values ¹⁾

Parameter	Symbol	Conditions	min	typ	max	Unit
Critical rate of rise of on-state current	di/dt_{crit}	$T_{vj} = 110\text{ °C}$, $I_T = 3000\text{ A}$, $V_D \leq 0.67 \cdot V_{DRM}$,			200	A/μs
		$I_{GM} = 5\text{ A}$, $t_r = 0.5\text{ μs}$	Cont. $f = 50\text{ Hz}$		1000	A/μs
Circuit-commutated turn-off time	t_q	$T_{vj} = 110\text{ °C}$, $I_T = 3000\text{ A}$, $V_R = 200\text{ V}$, $di_T/dt = -1.5\text{ A/μs}$, $V_D \leq 0.67 \cdot V_{DRM}$, $dV_D/dt = 20\text{ V/μs}$			950	μs

Characteristic values

Parameter	Symbol	Conditions	min	typ	max	Unit
Reverse recovery charge	Q_{rr}	$T_{vj} = 110\text{ °C}$, $I_T = 3000\text{ A}$, $V_R = 200\text{ V}$, $di_T/dt = -1.5\text{ A/μs}$	6500	8970	9900	μAs
Reverse recovery current	I_{RM}			105	140	A
Gate turn-on delay time	t_{gd}	$T_{vj} = 25\text{ °C}$, $V_D = 0.4 \cdot V_{RM}$, $I_{GM} = 5\text{ A}$, $t_r = 0.5\text{ μs}$	1.5		3.5	μs

Triggering

Maximum rated values ¹⁾

Parameter	Symbol	Conditions	min	typ	max	Unit
Peak forward gate voltage	V _{FGM}				12	V
Peak forward gate current	I _{FGM}				10	A
Peak reverse gate voltage	V _{RGM}				10	V
Average gate power loss	P _{G(AV)}		see Fig. 7			W

Characteristic values

Parameter	Symbol	Conditions	min	typ	max	Unit
Gate-trigger voltage	V _{GT}	T _{vj} = 25 °C			2.6	V
Gate-trigger current	I _{GT}	T _{vj} = 25 °C			400	mA
Gate non-trigger voltage	V _{GD}	V _D = 0.4·V _{DRM} , T _{vjmax} = 110 °C			0.3	V
Gate non-trigger current	I _{GD}	V _D = 0.4·V _{DRM} , T _{vjmax} = 110 °C			10	mA

Thermal

Maximum rated values ¹⁾

Parameter	Symbol	Conditions	min	typ	max	Unit
Operating junction temperature range	T _{vj}		5		110	°C
Storage temperature range	T _{stg}		-40		140	°C

Characteristic values

Parameter	Symbol	Conditions	min	typ	max	Unit
Thermal resistance junction to case	R _{th(j-c)}	Double-side cooled F _m = 170... 210 kN			3	K/kW
	R _{th(j-c)A}	Anode-side cooled F _m = 170... 210 kN			6	K/kW
	R _{th(j-c)C}	Cathode-side cooled F _m = 170... 210 kN			6	K/kW
Thermal resistance case to heatsink	R _{th(c-h)}	Double-side cooled F _m = 170... 210 kN			0.6	K/kW
	R _{th(c-h)}	Single-side cooled F _m = 170... 210 kN			1.2	K/kW

Analytical function for transient thermal impedance:

$$Z_{th(j-c)}(t) = \sum_{i=1}^n R_i (1 - e^{-t/\tau_i})$$

i	1	2	3	4
R _i (K/kW)	2.008	0.617	0.286	0.089
τ _i (s)	0.9272	0.1347	0.0175	0.0046

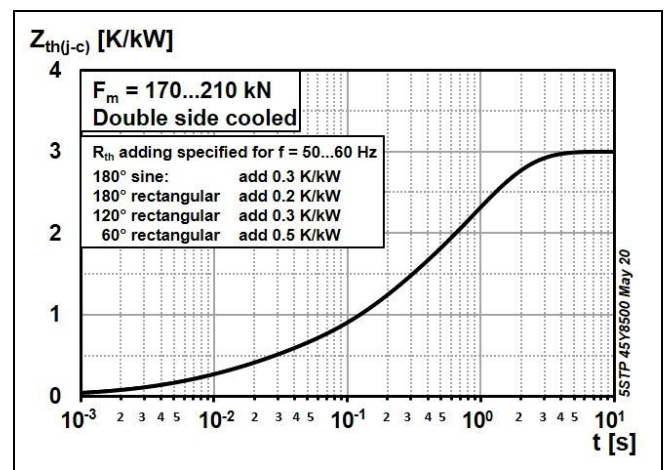

Fig. 1 Transient thermal impedance (junction-to-case) vs. time

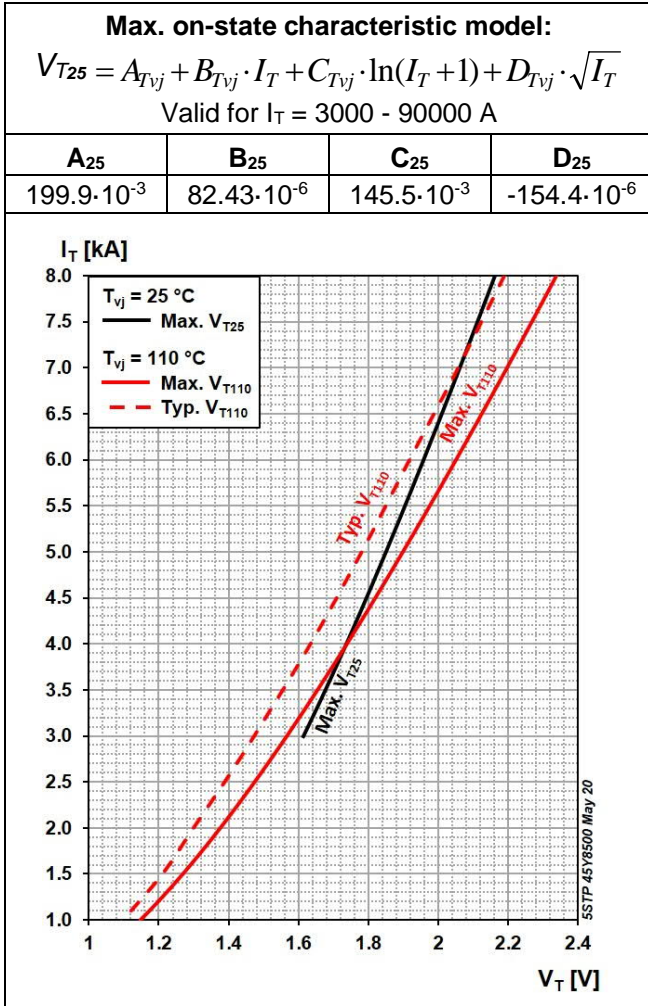

Fig. 2 On-state voltage characteristics

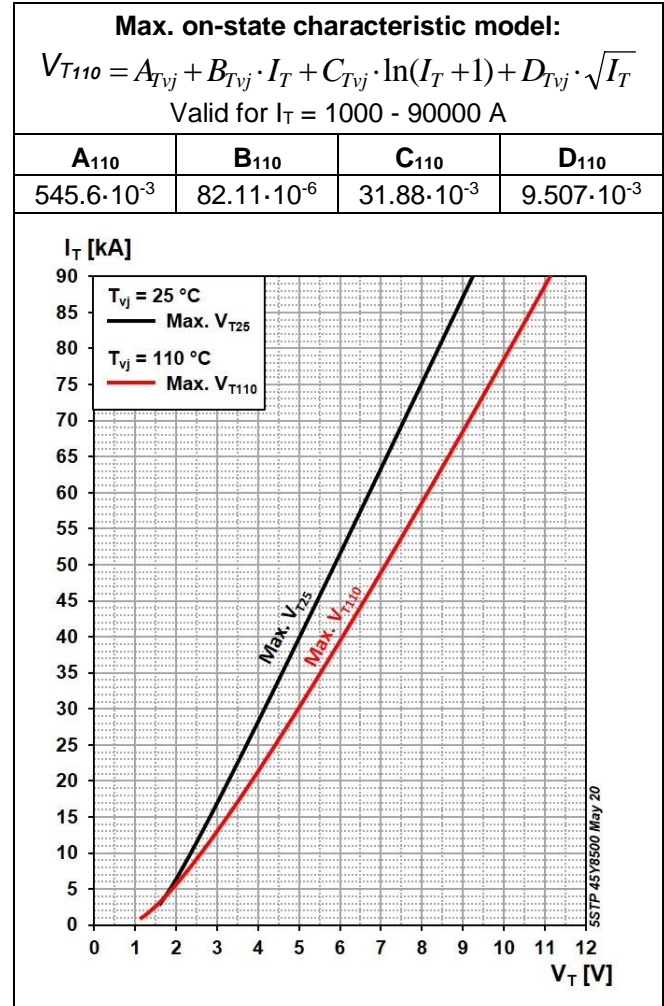

Fig. 3 On-state voltage characteristics

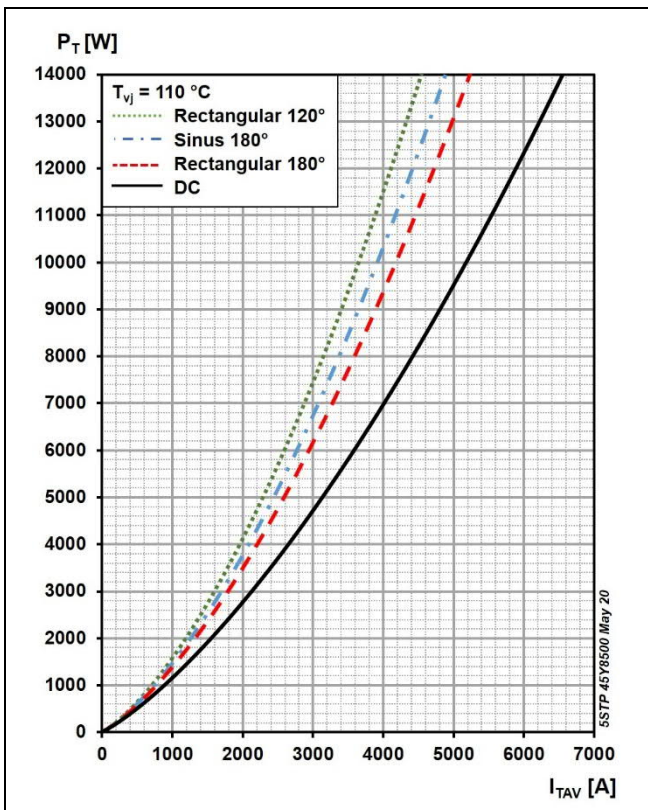

Fig. 4 On-state power dissipation vs. mean on-state current, turn-on losses excluded

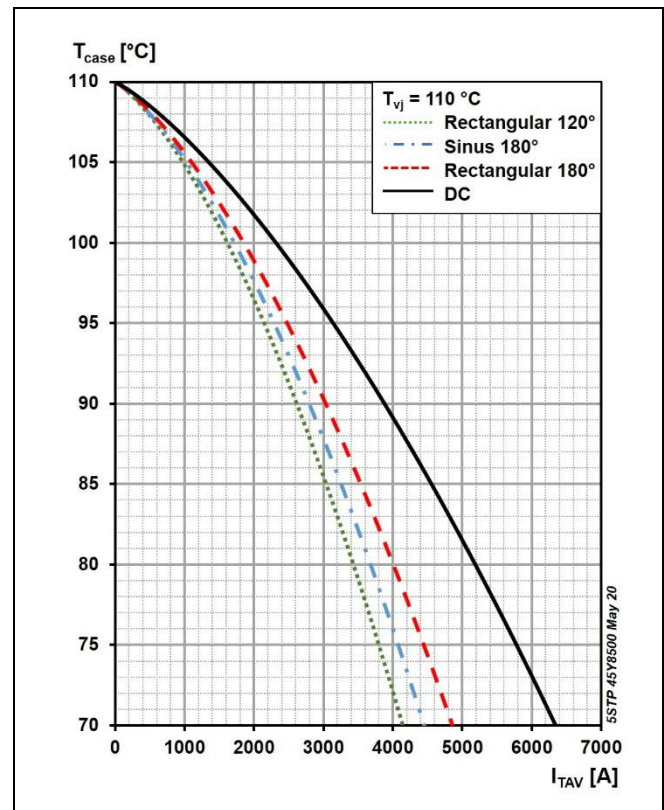

Fig. 5 Max. permissible case temperature vs. mean on-state current, switching losses ignored

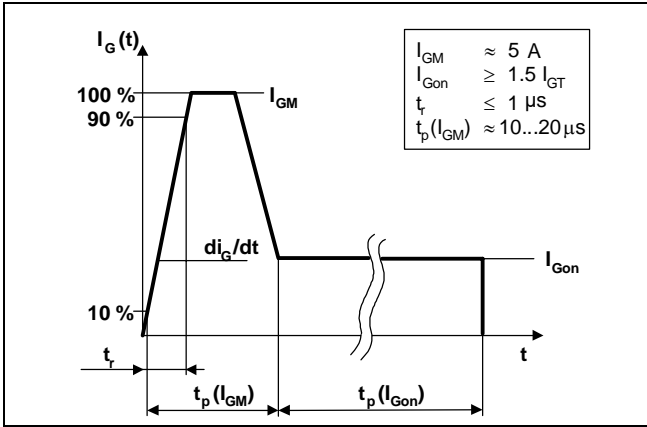

Fig. 6 Recommended gate current waveform

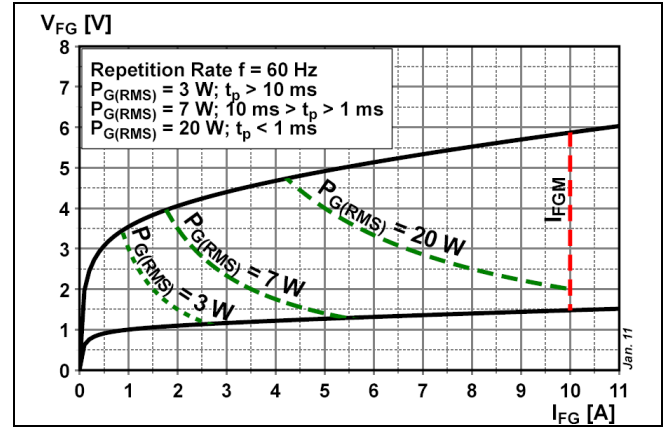

Fig. 7 Max. peak gate power loss

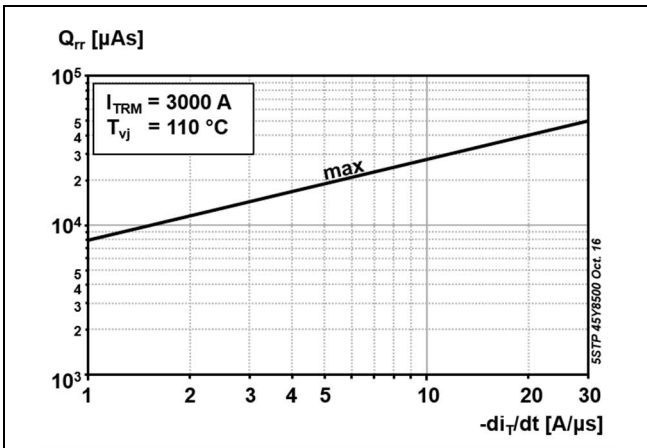

Fig. 8 Reverse recovery charge vs. decay rate of on-state current

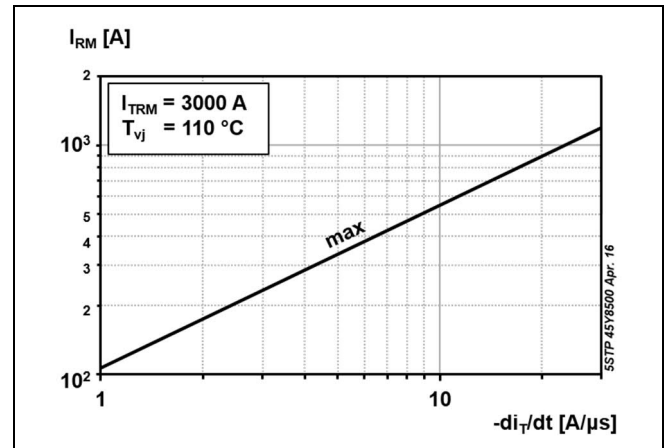

Fig. 9 Peak reverse recovery current vs. decay rate of on-state current

Power losses

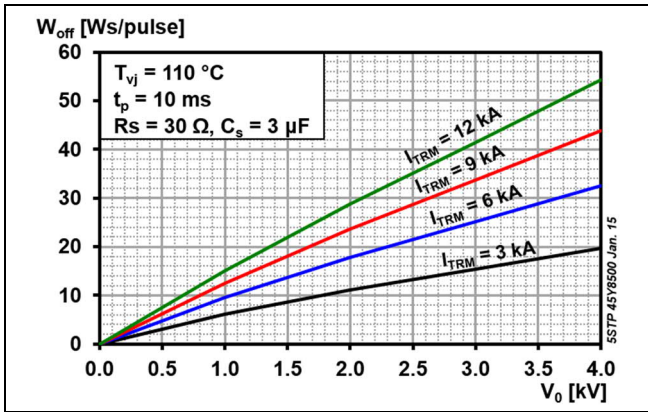

Fig. 10 Turn-off energy, half sinusoidal waves

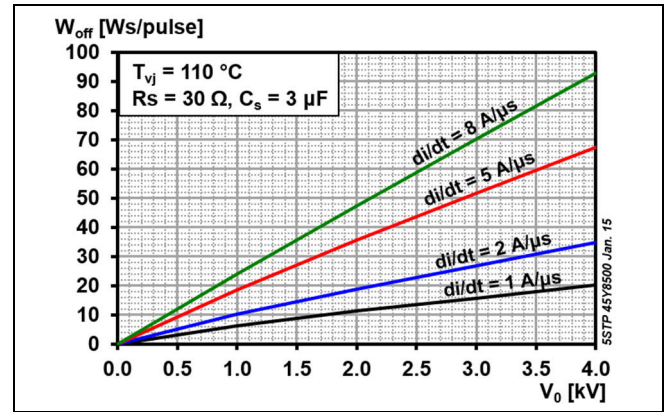

Fig. 11 Turn-off energy, rectangular waves

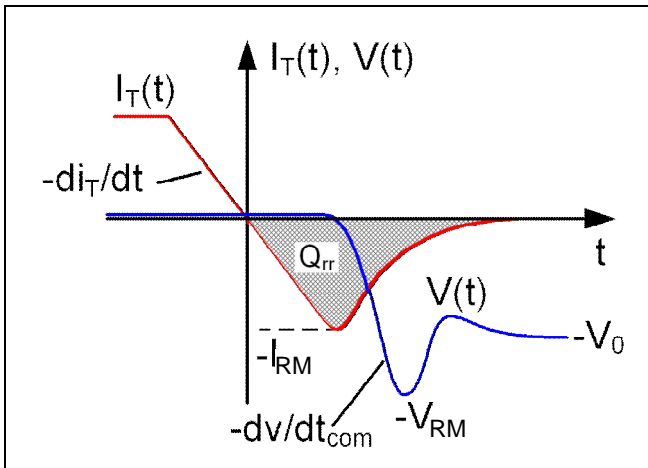

Fig. 12 Current and voltage waveforms at turn-off

Total power loss for repetitive waveforms:

$$P_{TOT} = P_T + W_{on} \cdot f + W_{off} \cdot f$$

where

$$P_T = \frac{1}{T} \int_0^T I_T \cdot V_T(I_T) dt$$

Fig. 13 Relationships for power loss

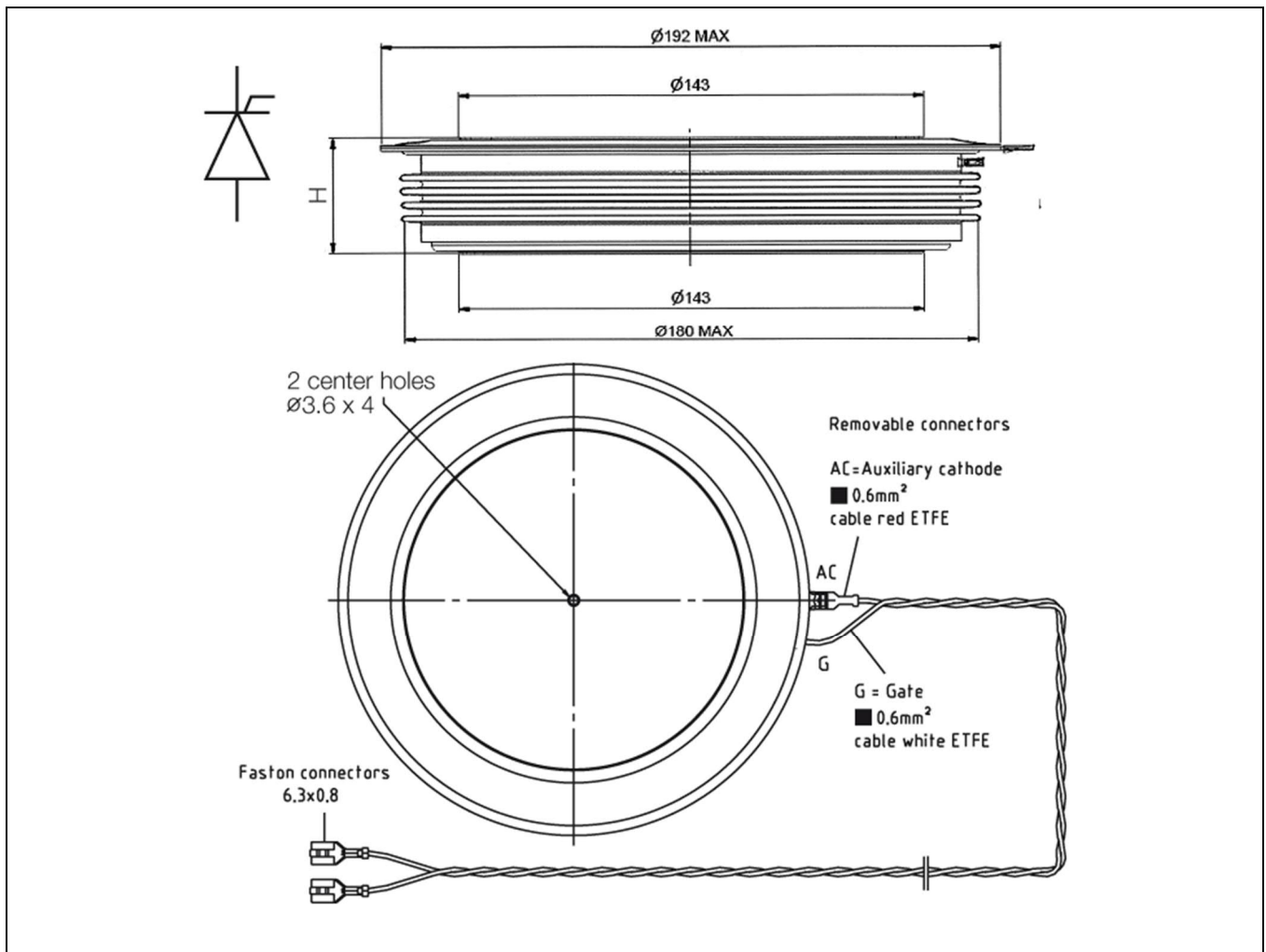

Fig. 14 Device Outline Drawing

Related documents:

5SYA 2020	Design of RC-Snubbers for Phase Control Applications
5SYA 2049	Voltage definitions for phase control and bi-directionally controlled thyristors
5SYA 2051	Voltage ratings of high power semiconductors
5SYA 2034	Gate-drive recommendations for phase control and bi-directionally controlled thyristors
5SYA 2036	Recommendations regarding mechanical clamping of Press-Pack High Power Semiconductors
5SYA 2102	Surge currents for Phase Control Thyristors
5SZK 9118	General Environmental Conditions for High Power Semiconductors

Please refer to <http://www.hitachiabb-powergrids.com/semiconductors> for current version of documents.

We reserve all rights in this document and in the subject matter and illustrations contained therein. Any reproduction, disclosure to third parties or utilization of its contents – in whole or in parts – is forbidden without prior written consent. We reserve the right to change specifications without notice.

ABB is a registered trademark of ABB Asea Brown Boveri Ltd Manufactured by/for a Hitachi Power Grids company. Copyright 2021 Hitachi Powergrids. All rights reserved.

ABB Power Grids Switzerland Ltd Semiconductors

Hitachi ABB Joint Venture
Fabrikstrasse 3
CH-5600 Lenzburg
Switzerland

Tel: +41 (0)58 586 14 19
Fax: +41 (0)58 586 13 06
Email: abbsem@hitachi-powergrids.com
Internet: www.hitachiabb-powergrids.com/semiconductors