

GaAs MMIC LOW NOISE AMPLIFIER, 24 - 36 GHz

Typical Applications

The HMC263LP4E is ideal for:

- Millimeterwave Point-to-Point Radios
- LMDS
- VSAT
- SATCOM

Features

- Low Noise Figure: 2.2 dB
- High Gain: 20 dB
- Single Positive Supply: +3V or +5V
- DC Blocked RF I/Os
- No External Matching
- 24 Lead 4x4mm QFN Package: 16mm²

Functional Diagram

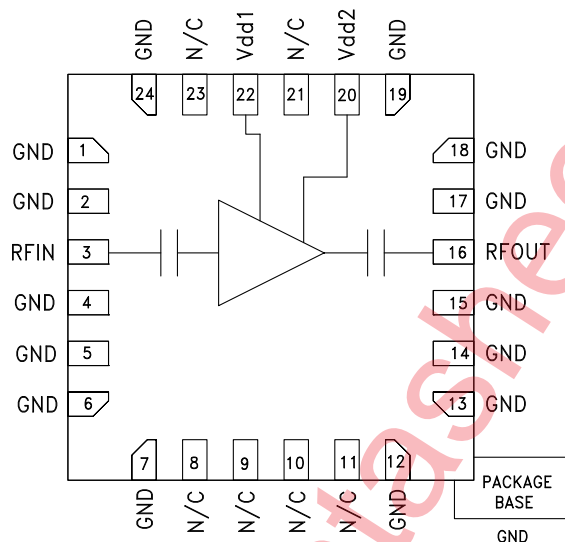

General Description

The HMC263LP4E is a GaAs MMIC Low Noise Amplifier (LNA) which covers the frequency range of 24 to 36 GHz and is housed in a leadless plastic SMT package. The HMC263LP4E utilizes a GaAs PHEMT process offering 20 dB gain from a single bias supply of + 3V @ 58 mA with a noise figure of 2.2 dB. The HMC263LP4E may be used in conjunction with HMC264LC3B or HMC265LM3 mixers to realize a millimeterwave system receiver. The RF I/Os are DC blocked and matched to 50 Ohms requiring no external components.

Electrical Specifications, $T_A = +25^\circ C$, $V_{dd} = +3V$

Parameter	Min.	Typ.	Max.	Min.	Typ.	Max.	Min.	Typ.	Max.	Units
Frequency Range	24 - 27			27 - 32			32 - 36			GHz
Gain	19	21	27	17	19	23	15	17	20	dB
Gain Variation Over Temperature		0.03			0.03			0.03		dB/°C
Noise Figure		2.0	3.0		2.2	3.0		2.5	4.0	dB
Input Return Loss		12			9			11		dB
Output Return Loss		10			9			9		dB
Output Power for 1 dB Compression (P1dB)		6			8			9		dBm
Saturated Output Power (P _{sat})		9			11			12		dBm
Output Third Order Intercept (IP3)		16			18			20		dBm
Supply Current (I _{dd}) (@ V _{dd} = +3V)		58	77		58	77		58	77	mA

GaAs MMIC LOW NOISE AMPLIFIER, 24 - 36 GHz

Gain vs. Temperature @ Vdd = +3V

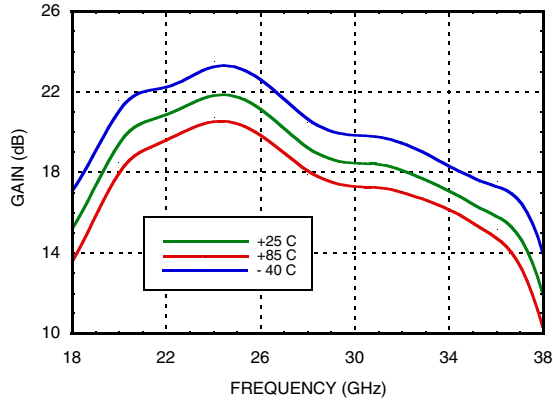

Gain vs. Temperature @ Vdd = +5V

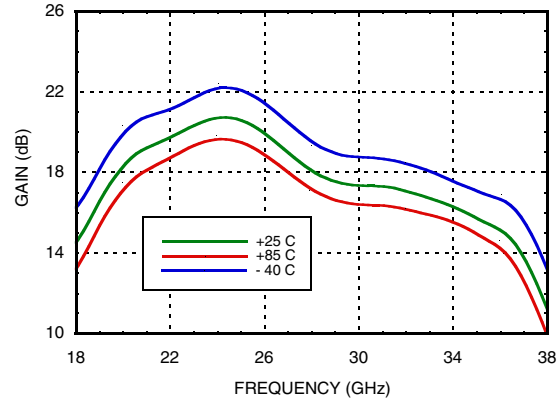

Input Return Loss @ Vdd = +3V

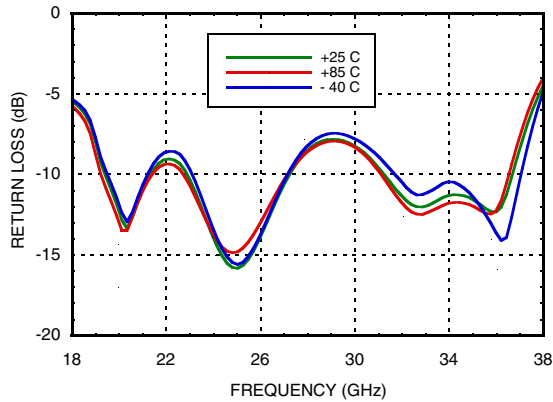

Input Return Loss @ Vdd = +5V

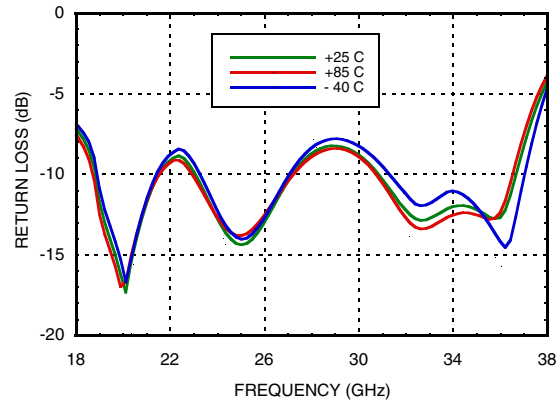

Output Return Loss @ Vdd = +3V

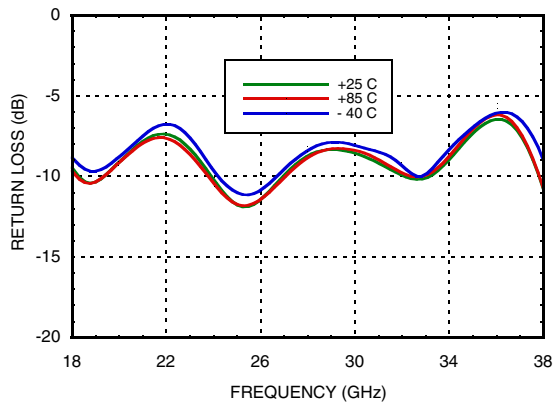

Output Return Loss @ Vdd = +5V

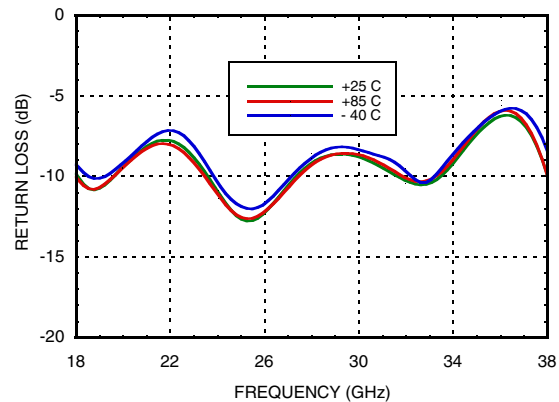

GaAs MMIC LOW NOISE AMPLIFIER, 24 - 36 GHz

Noise Figure vs. Temperature @ Vdd = +3V

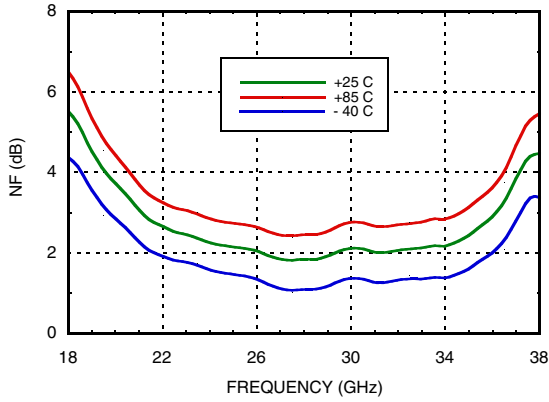

Noise Figure vs. Temperature @ Vdd = +5V

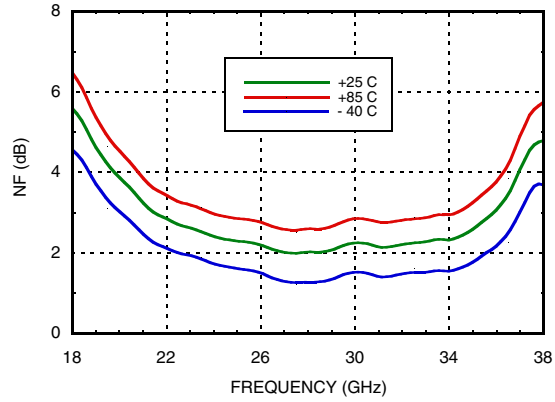

Isolation @ Vdd = +3V

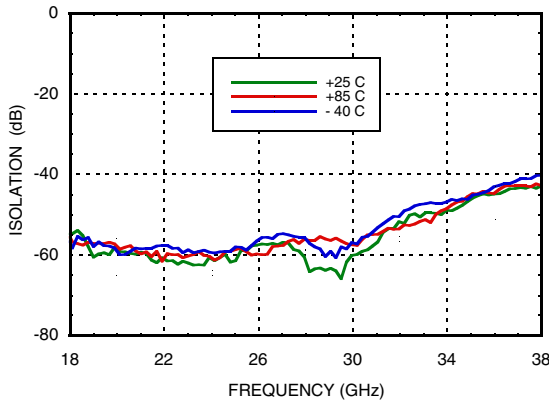

Isolation @ Vdd = +5V

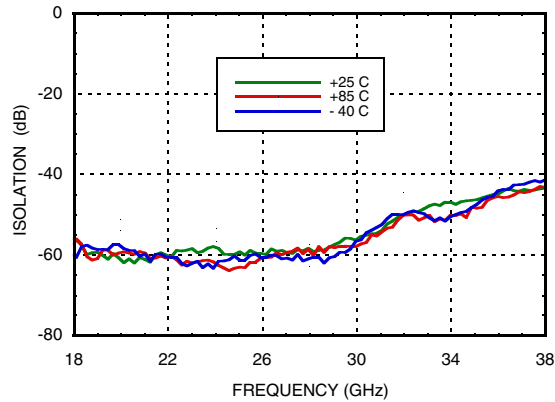

Output P1dB @ Vdd = +3V

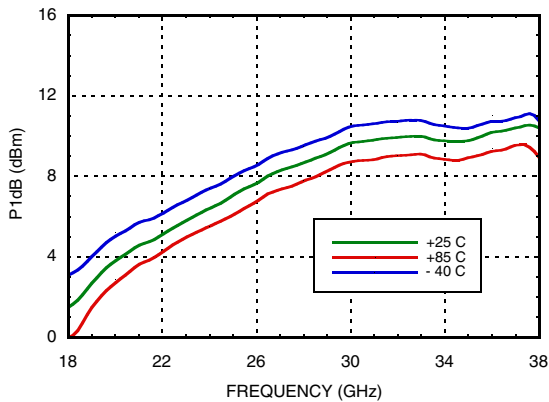

Output P1dB @ Vdd = +5V

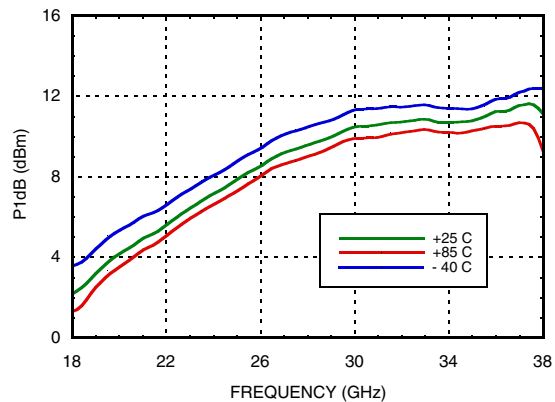

GaAs MMIC LOW NOISE AMPLIFIER, 24 - 36 GHz

Psat @ Vdd = +3V

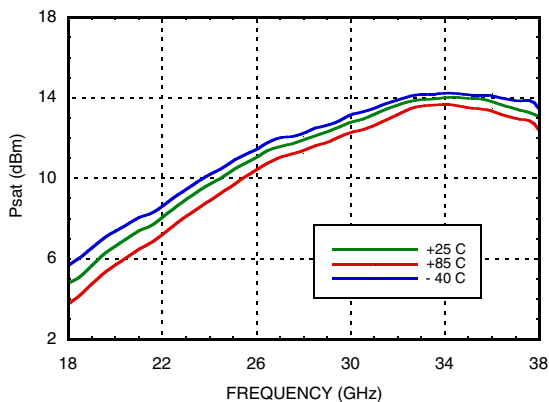

Psat @ Vdd = +5V

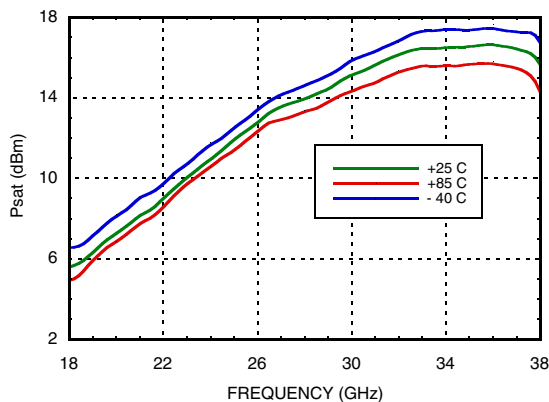

Output IP3 @ Vdd = +3V

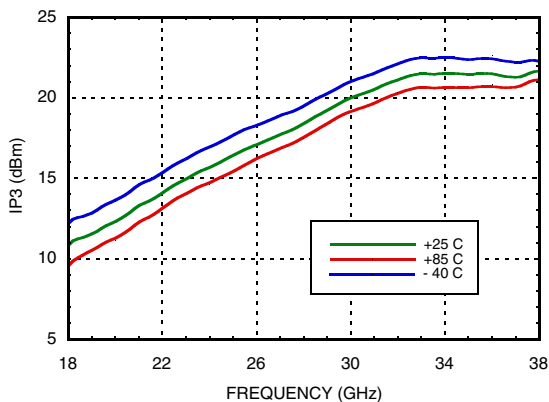

Output IP3 @ Vdd = +5V

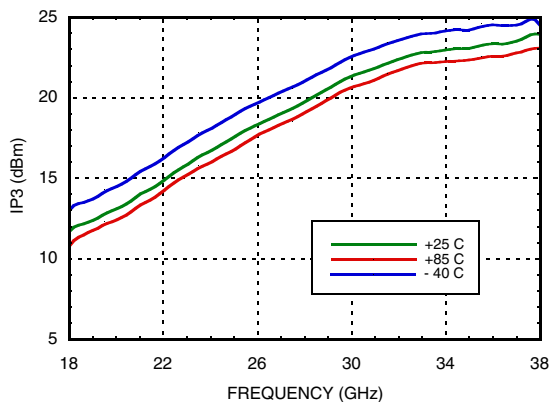

**Additive Phase Noise Vs Offset Frequency,
RF Frequency = 30 GHz,
RF Input Power = -8 dBm (P1dB)**

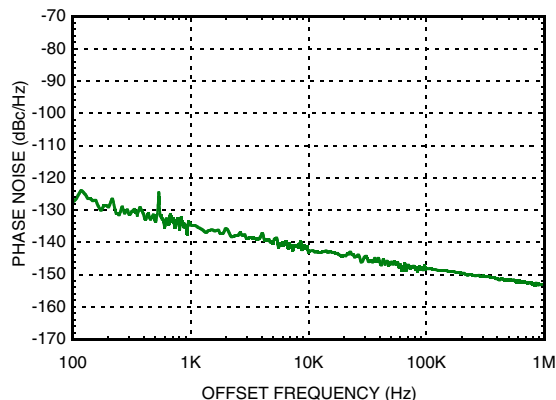

GaAs MMIC LOW NOISE AMPLIFIER, 24 - 36 GHz

Absolute Maximum Ratings

Drain Bias Voltage (Vdd1, Vdd2)	+5.5 Vdc
RF Input Power (RFIN)(Vdd = +3 Vdc)	-5 dBm
Channel Temperature	175 °C
Continuous Pdiss (T = 85 °C) (derate 7.7 mW/°C above 85 °C)	0.7 W
Thermal Resistance (channel to ground paddle)	130 °C/W
Storage Temperature	-65 to +150 °C
Operating Temperature	-40 to +85 °C



ELECTROSTATIC SENSITIVE DEVICE
OBSERVE HANDLING PRECAUTIONS

Outline Drawing

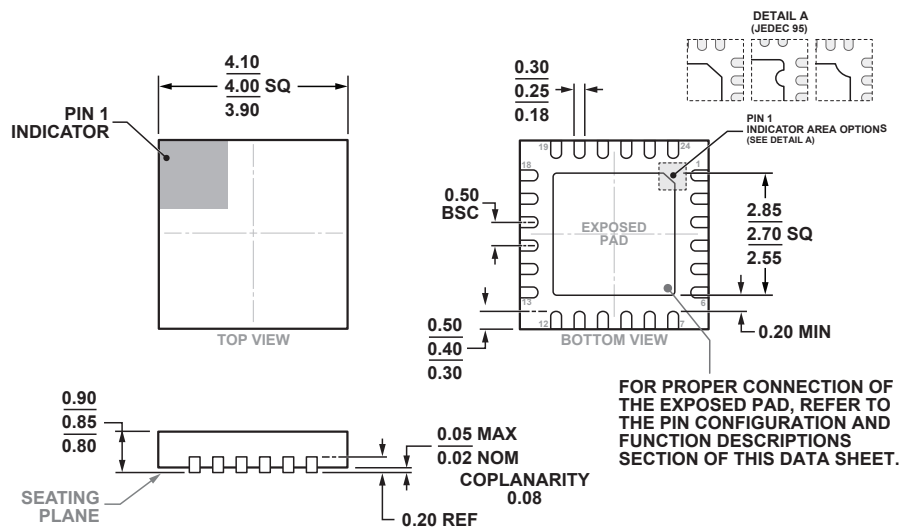

COMPLIANT TO JEDEC STANDARDS MO-220-VGGD-8.

24-Lead Lead Frame Chip Scale Package [LFCSP]
4 mm × 4 mm Body and 0.85 mm Package Height
(CP-24-16)

Dimensions shown in millimeters.

Package Information

Part Number	Package Body Material	Lead Finish	MSL Rating	Package Marking ^[1]
HMC263LP4E	RoHS-compliant Low Stress Injection Molded Plastic	100% matte Sn	MSL3 ^[2]	H263 XXXX

[1] 4-Digit lot number XXXX

[2] Max peak reflow temperature of 260 °C

GaAs MMIC LOW NOISE AMPLIFIER, 24 - 36 GHz

Pin Description

Pin Number	Function	Description	Interface Schematic
1, 2, 4 - 7, 12 - 15, 17 - 19, 24	GND	Package bottom has exposed metal paddle that must be connected to RF/DC ground.	
3	RFIN	This pin is AC coupled and matched to 50 Ohm.	
8 - 11, 21, 23	N/C	Not connected.	
16	RFOUT	This pin is AC coupled and matched to 50 Ohm.	
22, 20	Vdd1, Vdd2	Power supply for the 4-stage amplifier. See application circuit for required external components.	

Application Circuit

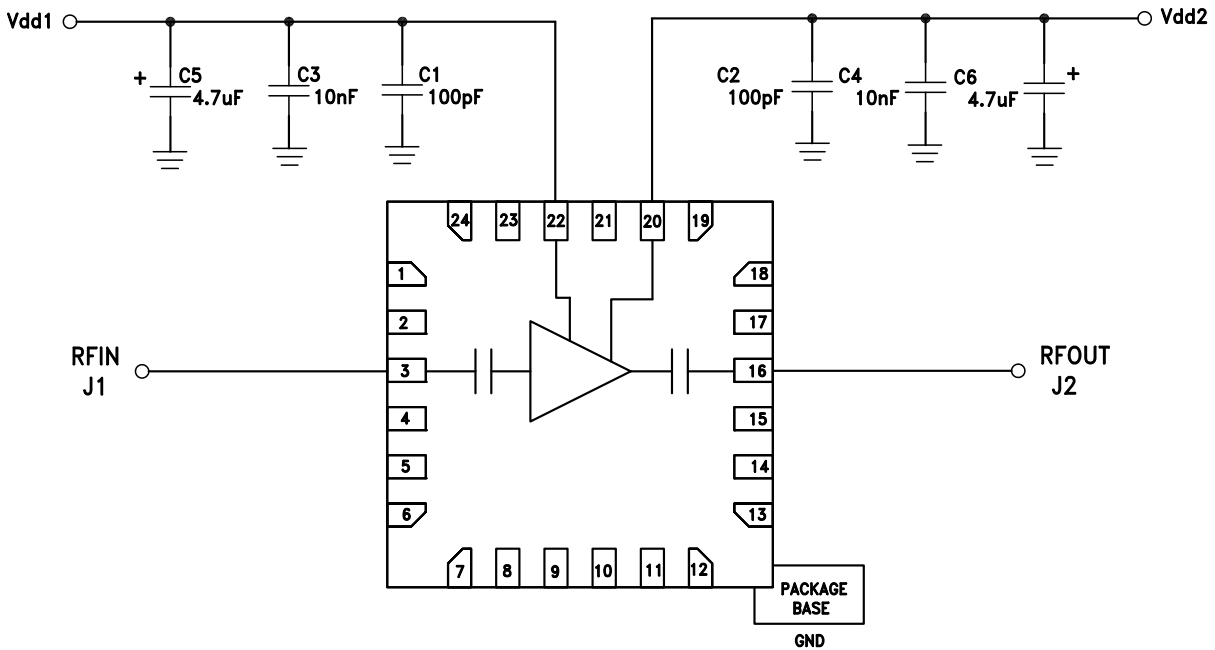

**GaAs MMIC LOW NOISE
AMPLIFIER, 24 - 36 GHz**

Evaluation PCB

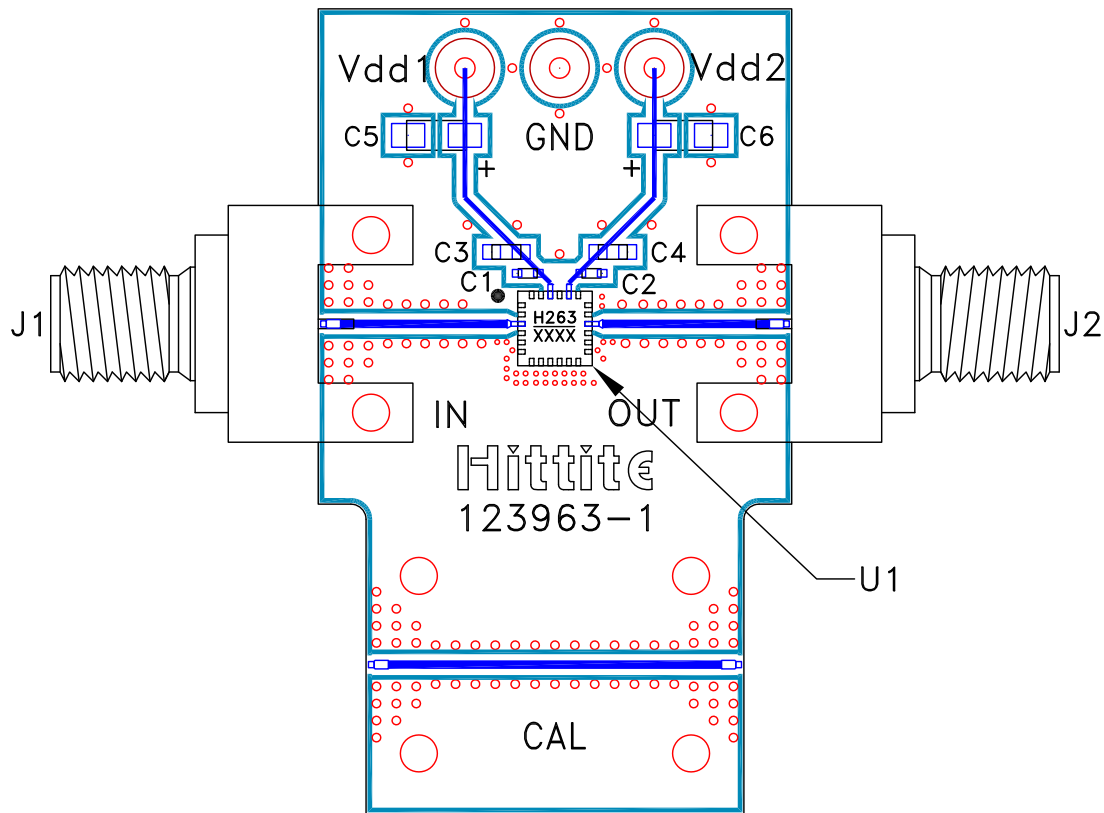

List of Materials for Evaluation PCB 123965 [1]

Item	Description
J1, J2	PCB Mount K Connector
J3 - J5	DC Pin
C1, C2	100 pF Capacitor, 0402 Pkg.
C3, C4	10 nF Capacitor, 0603 Pkg.
C5, C6	4.7 μF Capacitor, Tantalum
U1	HMC263LP4E
PCB [2]	123963 Evaluation PCB

[1] Reference this number when ordering complete evaluation PCB

[2] Circuit Board Material: Rogers 4350 or Arlon 25 FR

The circuit board used in the application should use RF circuit design techniques. Signal lines should have 50 Ohm impedance while the package ground leads and package bottom should be connected directly to the ground plane similar to that shown. A sufficient number of via holes should be used to connect the top and bottom ground planes. The evaluation board should be mounted to an appropriate heat sink. The evaluation circuit board shown is available from Analog Devices, upon request.

Mouser Electronics

Authorized Distributor

Click to View Pricing, Inventory, Delivery & Lifecycle Information:

[Analog Devices Inc.:](#)

[123965-HMC263LP4E](#) [HMC263LP4ETR](#) [HMC263LP4E](#)