

Amphenol AIB/GT Series MIL-DTL-5015



IMPROVED COUPLING OVER THREADED MIL-DTL-5015

The AIB/GT Series replaces the threaded coupling used in MIL-DTL-5015 with a positive, quick-mating, three-point reverse bayonet lock for improved performance. These Amphenol connectors are an ideal cost-effective option for applications requiring reliability in harsh environments, and is the world-standard for rail, mass transit, and military ground vehicle applications. This series has the same shell dimensions, contact layouts, contacts, and performance characteristics as the MIL-DTL-5015 threaded connectors; however, the two series do not intermate. They are sealed to withstand moisture, condensation, vibration and flash-over. Over 180 contact layouts are available, in variations that allow for just power, just signal, or a mix of both contact types.

- Meets NATO specification VG95234

COMMERCIAL & MILITARY

AIB/GT series connectors are made in accordance with German military specification VG95234 and MIL-DTL-5015. Originally designed for NATO combat vehicles, aircraft, and airborne equipment, these rugged connectors are now in a broad range of demanding commercial applications from trucks to industrial robots.

APPLICATIONS

Industrial environments requiring extreme environmental reliability and ease of mating and unmating, such as:

- Power generators
- Battery systems
- Engines
- Sensors
- Motion control
- Off-road vehicles
- Earth-moving equipment
- Ships
- Railroad equipment
- Mobile equipment
- Industrial machinery
- Telecommunications
- Mass transit

FEATURES

SIMPLE AND FAST MATING AND UN-MATING

AIB/GT series connectors use a unique “reverse bayonet” coupling system that allows for mating and un-mating with a simple 120° rotation without compromising shock, vibration, or moisture resistance. The large, open ramps are easily cleaned of mud or other contaminants. The ramp coupling system eliminates the possibility of cross-threading and thread damage possible with standard MIL-DTL-5015 threaded connectors. This design is easier to mate in cold weather, tight spaces, or on equipment which must be disassembled frequently.

SHOCK AND VIBRATION RESISTANCE

AIB/GT series connectors are supplied with military-standard resistant sealing and a three-point bayonet coupling nut. The three-point bayonet coupling incorporates a wave spring and washer specified by the rail industry. AIB/GT series connectors pass the most stringent tests of shock and vibration performance while maintaining proper continuity and water tightness. Rugged aluminum alloy shell and hardware are light in weight yet highly resistant to damage.

FEATURES

AUDIBLE, VISUAL, AND TACTILE CONFIRMATION OF MATING

AIB/GT series connectors provide three independent checks that the connector halves are mated. When the coupling nut is fully rotated, the three studs snap into the end of the ramps with a loud “click” (audible). The user can feel the bolts click into the grooves (tactile). Blue dots on the receptacle and coupling nut are aligned when the connector is properly mated (visual).

ENVIRONMENTAL

The sealing is not compromised by any of the operating conditions defined in MIL-DTL-5015 and is completely watertight when mated.

BROAD TEMPERATURE RANGE

These connectors will operate in temperatures from -67° to +257°F (-55° to +125°C). High-temperature and zero-halogen insulators are also available. Contact us for ordering information.

WIDE RANGE OF WIRE GAUGES AND CURRENT-CARRYING CAPABILITY

Up to 150 amps with accommodations for wire gauges from size 26 to size 0 AWG.

WIDE VARIETY OF CONTACTS

High-reliability screw machine contacts with silver or gold plating are available in sizes from 20 to 0 to accommodate wire gauges from 26 to 0 AWG. Solder, crimp, PC, coax, and thermocouple contacts are available.

AIB/GT connectors use rail industry-standard crimp contacts that are completely interchangeable with other rail connectors such as Litton/Veam CIR series.

INTERMATEABLE AND INTERMOUNTABLE WITH ALL VG95234 CONNECTORS

The standard MIL-DTL-5015 layouts and dimensions ensure intermateability and intermountability with all connectors made in accordance with VG95234.

All AIB/GT connectors are intermountable with standard threaded MIL-DTL-5015 connectors, often making it possible to upgrade without changing panel cutouts or clearances.

TECHNICAL SPECIFICATIONS

MATERIALS & FINISHES

Shell	Aluminum alloy. (Can be grounded)
Plating	Olive drab chromate coating over cadmium plating, conductive black alloy, black alloy, electroless nickel, green zinc, and black anodized
Contacts	Copper alloy
Platings	Hard silver plating or gold plating
Insulator*	Neoprene
Seals	Silicone, Neoprene, or Viton®**

*Optional zero-halogen and high-temperature insulators are available. Contact us for information.

**Viton® is a registered trademark of DuPont DOW Elastomers

ELECTRICAL DATA

Operating Voltage/Test Voltage according to MIL-DTL-5015H

The indicated values for the operating voltage are limits concerning the electrical function. When the working voltage exceeds 50V, safety precautions must be in accordance with the following standards: VDE 0100, IEC 309-1 or applicable national standards.

Current Rating

CONTACT SIZE	TEST CURRENT (AMPS)
16/16S	13
12	23 (60)*
8	46 (69)*
4	80 (120)*
0	150 (225)*

*Test amps, multiconductor using Radsok contact

Altitude Voltage Derating* Chart

MS SERVICE RATING	NOMINAL DISTANCE		OPERATING VOLTAGE*		STANDARD SEA LEVEL CONDITIONS		PRESSURE ALTITUDE† 50,000 FEET		PRESSURE ALTITUDE† 70,000 FEET	
	AIRSPACE	CREEPAGE	DC V	AC VRMS	MINIMUM FLASHOVER VOLTAGE AC (RMS)	TEST VOLTAGE AC (RMS)	MINIMUM FLASHOVER VOLTAGE AC (RMS)	TEST VOLTAGE AC (RMS)	MINIMUM FLASHOVER VOLTAGE AC (RMS)	TEST VOLTAGE AC (RMS)
I	1/32	1/16	250	200	1,400	1,000	550	400	325	260
A	1/16	1/8	700	500	2,800	2,000	800	600	450	360
D	1/8	3/16	1,250	900	3,600	2,800	900	675	500	400
E	3/16	1/4	1,750	1,250	4,500	3,500	1,000	750	550	440
B	1/4	5/16	2,450	1,750	5,700	4,500	1,100	825	600	480
C	5/16	1	4,200	3,000	8,500	7,000	1,300	975	700	560

* No attempt has been made to recommend operating voltages. The designer must determine own operating voltage by the application of a safety factor to the above derating chart to compensate for circuit transients, surges, etc.

† Not corrected for changes in density due to variations in temperature.

Wire Range Sizes

26 AWG to 0 AWG (See contact selection on [pages 94-97](#))

Contact Resistance

per MIL-DTL-5015H
p 3.15

CONTACT SIZE	CONTACT RESISTANCE MILLIOHM MAX.	POTENTIAL VOLTAGE DROP IN MILLIVOLTS MAX.
16/16S	6	21
12	3	20
8	1/(0.44)*	12 (20)*
4	0.5/(0.23)*	10 (18)*
0	0.2/(0.18)*	10 (27)*

*Using Radsok contact

Insulation Resistance

@77°F (25°C) > 5,000 Megohms

MECHANICAL

Operating Temperature -67° to +257°F (-55° to +125°C) Neoprene

Sealing

33-foot submersible

Sealed when mated. ≈ IP 67 and NEMA 4P

**TECHNICAL
SPECIFICATIONS**

Wire Sealing Range

The connector is designed for individual wire sealing. Sealing of an outer cable jacket on multiconductor cables must be accomplished with an appropriate endbell. Sealing is only guaranteed if wires used are according to MIL-W-5086 or within the listed ranges.

CONTACT SIZE	SEALING RANGE	
	INCHES	MM
16	.064 - .130	1.62 - 3.30
12	.114 - .170	2.89 - 4.31
8	.164 - .255	4.16 - 6.47
4	.272 - .370	6.90 - 9.30
0	.415 - .550	10.50 - 13.97

Insulation Strip Lengths

See Contact Selection Chart on [pages 94 and 97](#)

Mating Life

2,000 cycles minimum (AIB/GT) 500 cycles minimum (AIBC/ACA-B)

Salt Spray

Olive drab chromate over cadmium - 500 hours
 Black alloy - 48 to 200 hours
 Conductive black alloy - 48 to 200 hours
 Black anodized - 500+ hours
 Electroless nickel - 48 hours

Heat

Neoprene low-smoke, zero-halogen (LSZH) 257°F (+125°C);
 Viton 392°F (+200°C)

Chemical Resistance

Diesel Fuel 48-hour intermittent spray for each
 JP-4 chemical with no deterioration,
 Hydraulic Fluid followed by Contact Retention (CR),
 Gasoline Insulation Resistance (IR), Dielectric Withstanding
 Voltage tests (DWW)

Corrosion Resistance

Olive Drab Cadmium-Plated 48 hours per MIL-DTL-5015 (3.17/4.6.13)

Fluid Immersion

Hydraulic Fluid 20 hours per MIL-DTL-5015 (3.19/4.6.15)
 Lubrication Oil 20 hours per MIL-DTL-5015 (3.19/4.6.15)

Vibration

Per MIL-STD-810C, method 516.2, procedure VIII
 1.0 g peak from 5 to 25 Hz
 .030" double amplitude from 25 to 57 Hz
 5g peak from 57 to 500 Hz

Basic Shock

Per MIL-STD-810C, method 516.2, procedure I pulse at half-sine
 wave of 30g for 11 seconds

Gun fire Shock

Per MIL-STD-810C, method 516.2, procedure IV pulse at half-sine
 wave of 100g for 1.5 seconds

Ballistic Shock

Per MIL-STD-810C, method 516.2, procedure IV pulse at half sine
 wave of 200g for .5 seconds

Contact Type

Solder, crimp, PC, coax, or thermocouple. Hard silver or gold plating.

Contact Insertion

From rear with simple hand-tool. Removable, 5 cycles minimum.

Contact Retention

Pin and socket contacts are designed to resist severe vibration and repeated connection and disconnection. Contact retention and separation is tested according to MIL-DTL-5015H (4.6.6.1)

CONTACT SIZE	RETENTION FORCE MIN.
16	10
12	15
8	20
4	20
0	25

TECHNICAL SPECIFICATIONS

Number of Circuits	1 to 85																																															
Polarization	Key and keyway plus three point bayonet with optional rotational polarization. See pages 83-93 .																																															
Rear Accessories	<p>Maximum Torque</p> <table border="1"> <thead> <tr> <th>SIZE</th> <th>IN./LB. MAX.</th> </tr> </thead> <tbody> <tr><td>10SL</td><td>26</td></tr> <tr><td>14S</td><td>44</td></tr> <tr><td>16</td><td>50</td></tr> <tr><td>16S</td><td>50</td></tr> <tr><td>18</td><td>55</td></tr> <tr><td>20</td><td>65</td></tr> <tr><td>22</td><td>85</td></tr> <tr><td>24</td><td>90</td></tr> <tr><td>28</td><td>114</td></tr> <tr><td>32</td><td>120</td></tr> <tr><td>36</td><td>153</td></tr> <tr><td>40</td><td>170</td></tr> </tbody> </table> <table border="1"> <thead> <tr> <th colspan="3">THERMOCOUPLE CODES</th> </tr> <tr> <th>MATERIAL</th> <th>COLOR CODE</th> <th>CODE</th> </tr> </thead> <tbody> <tr><td>Iron</td><td>Black</td><td>IR</td></tr> <tr><td>Constantan</td><td>Yellow</td><td>CON</td></tr> <tr><td>Copper Alloy</td><td>–</td><td>Cu</td></tr> <tr><td>Chromel</td><td>White</td><td>CH</td></tr> <tr><td>Alumel</td><td>Green</td><td>AL</td></tr> </tbody> </table> <p>Color code is identified by small dot on wire well end of contact.</p> <p>Thermocouple Types: J = Iron-Constantan K = Alumel-Chromel T = Copper-Constantan E = Chromel-Constantan</p>	SIZE	IN./LB. MAX.	10SL	26	14S	44	16	50	16S	50	18	55	20	65	22	85	24	90	28	114	32	120	36	153	40	170	THERMOCOUPLE CODES			MATERIAL	COLOR CODE	CODE	Iron	Black	IR	Constantan	Yellow	CON	Copper Alloy	–	Cu	Chromel	White	CH	Alumel	Green	AL
SIZE	IN./LB. MAX.																																															
10SL	26																																															
14S	44																																															
16	50																																															
16S	50																																															
18	55																																															
20	65																																															
22	85																																															
24	90																																															
28	114																																															
32	120																																															
36	153																																															
40	170																																															
THERMOCOUPLE CODES																																																
MATERIAL	COLOR CODE	CODE																																														
Iron	Black	IR																																														
Constantan	Yellow	CON																																														
Copper Alloy	–	Cu																																														
Chromel	White	CH																																														
Alumel	Green	AL																																														
Approvals/Agency Listing	UL File# E115497																																															

AIB/GT SERIES CROSS-SECTION

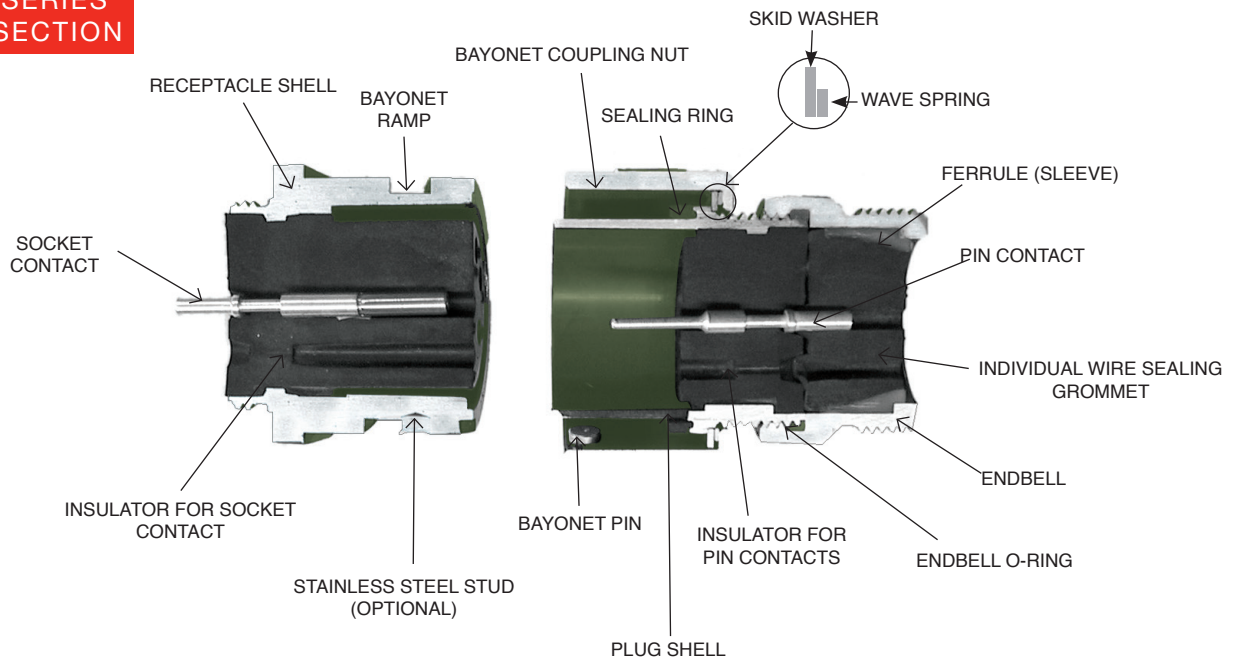

AIB/GT SERIES HOW TO ORDER

The next page shows all of the standard possibilities for AIB/GT series connectors. Follow the nine steps to create a description of the connector best suited to your application. This is not an Amphenol part number, but gives you a convenient way to select your connector. Contact us with the description for a valid Amphenol part number. If you prefer to select the Amphenol part number, see the How-To-Order Guide on [pages 70-71](#).

Many additional options not shown are available. Contact us if your needs are not met by the options on the next page.

CREATE YOUR PART NUMBER USING THESE NINE STEPS

1	2	3	4	5	6	7	8	9
AIB	6HD	F	A	24-28	P	W	S	-472
CONNECTOR TYPE	SHELL STYLE	END BELLS (If omitting endbell, enter -)	CABLE CLAMP/BOOT (If needed)	LAYOUT	CONTACT	ROTATION (omit for normal)	CONTACT TYPE	PLATING/MODIFICATION

STEP 1: SELECT CONNECTOR TYPE

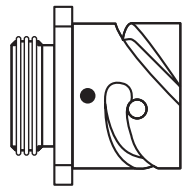

AIB*

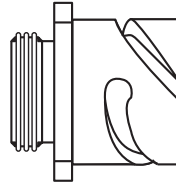

AIBC*

* AIBC is the commercial version of the AIB. It comes without wear pins in the receptacles and without wave springs in the coupling nuts.
Note: AIBC are fully intermateable with all reverse bayonet connectors.

STEP 2: SELECT SHELL STYLE, PLUG OR RECEPTACLE

PLUGS

Mates with

RECEPTACLES

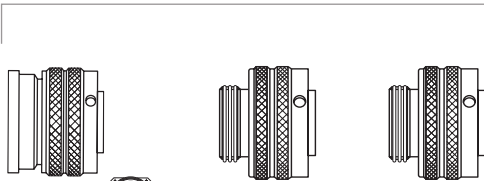

6B Box Mount

6 Standard Plug

G6 Shielded Plug

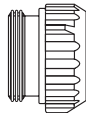

4 Rubber-Covered

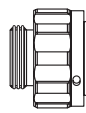

6HD Heavy-Duty

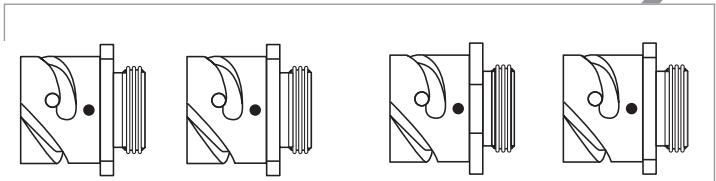

0 Front Wall Mount with Accessory Threads

30 Rear Wall Mount with Accessory Threads (Most Popular)

1 Cable Mount with Accessory Threads

20 Front Box Mount with Rear Accessory Threads

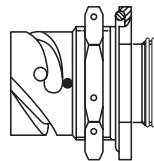

70 Rear Mount Jam Nut with Accessory Threads

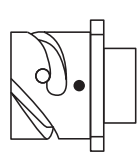

2 Front Box Mount No Accessory Threads

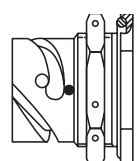

7 Rear Mount Jam Nut No Accessory Threads

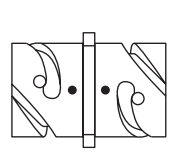

TB Thru Bulkhead

STANDARD SPECIALS — CALL WITH NPT THREAD SIZE, SEALTITE CONDUIT DIAMETER, OR CABLE OUTSIDE DIAMETER.

SHIELDED CABLE/HEAT SHRINK



LOW COST GLAND SEAL



SHIELDED CABLE BANDING

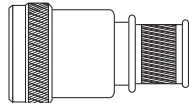

INTERNAL THREAD VERSION

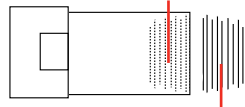

EXTERNAL THREAD VERSION

GLAND SEAL

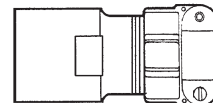

CONDUIT METAL

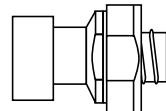

MESH GRIP

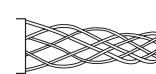

CONDUIT PLASTIC

➔ See pages 444-445

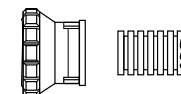

STEP 3: SELECT CABLE CLAMP OR BOOT (IF APPLICABLE)

TIP: Order connector, backshell and all accessories as one part number! See www.peigenesis.com/en/solution-guides.html



RV
No Clamp

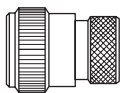

G Heat Shrink

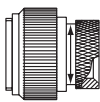

G2 Spin Coupling
Heat Shrink

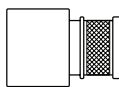

U Low-Cost
Shielded

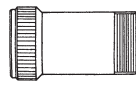

L Long Extender



A Unsealed
(no grommet seal)

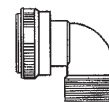

T MS Style
(MS3108) 90°



P Potting
*Potting
Compound
⇒ See
Page 443

F Sealed
(with grommet seal)

STEP 4: SELECT CABLE CLAMP OR BOOT (IF APPLICABLE)



Heat Shrink Boot
Call with cable outside
diameter ⇒ See pages
440-441.

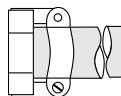

A MS3057-A
Standard Cable Clamp

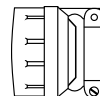

C MS3057-C
Gland Seal ⇒ See
Page 112

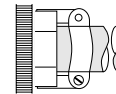

9767 9767
Gland Seal for smaller cable
range. ⇒ See Page 113

STEP 5: SELECT LAYOUT

⇒ See pages 72-82

STEP 6: SELECT CONTACT

P = Pin **S** = Socket **PS** = Style TB Only

STEP 7: SELECT ROTATION

⇒ See pages 83-93 (Omit for normal)
W, X, Y, Z

STEP 8: SELECT CONTACT TYPE

S = Solder **C** = Crimp*
H = PC** **O** = Less Contacts

* When using a "C" in part number, the connector is supplied with the standard size crimp contacts for its layout. Bolded part numbers on ⇒ page 94-96 indicate crimp contact. Please call for connectors with reduced or enlarged crimp barrel contacts.
⇒ ** See page 99 for post diameters and lengths.

STEP 9: SELECT PLATING

CONTACTS

(Omit for silver contacts)

B30 = Gold 30µ" Gold over Nickel
T = Thermocouple (Solder only)
RDS = RADSOK (Socket only) 12, 8, 4, 0

SHELL PLATING

(Omit for olive drab chromate over cadmium)

023 = Nickel (RoHS with crimp or 116 contacts)
024 = Green Zinc Cobalt
025 = Black Zinc Alloy
(RoHS with crimp or 116 contacts)
027 = Conductive Black Zinc Alloy
(RoHS with crimp or 116 contacts)
G96 = Black Anodized
116 = Less Pre-tinned Solder Cups
472 = 116 & 025 mod codes (RoHS)
548 = 116 & 023 mod codes (RoHS)
553 = 116 & 027 mod codes (RoHS)

MATERIALS

L = Low-smoke, zero-halogen
V = High-temperature Viton®*

















*Viton® is a registered trademark of DuPont Dow Elastomers

LAYOUTS BY NUMBER OF CONTACTS



















CONTACT LEGEND ⊕=16 ●=12 ⊙=8 ○=4 ⊗=0
 Mating face view of pin inserts

SERIES KEY: AIB (●=GT) AIT (⊕=MS; ⊙=non QPL) 97 (⚡=97)
 VG95234 (■) MS3450 (▼=MS; ▽=non QPL) Thermocouple (⚡)









1 CONTACT

								
LAYOUT	8S-1	10S-2	12S-4	12-5	14S-4	14-3	16S-3	16-2
# OF CONTACTS	1-#16	1-#16	1-#16	1-#12	1-#16	1#8	1#16	1-#12
SERIES	⊕ ⊙ ▼	⊕ ▼	⊕ ▼	⊕ ⊙ ▼	● ⊕ ⊙	⊕ ▼	▽ ⊕	● ⊕ ▼
SERVICE RATING	A	A	D	D	D	A	B	E
								
LAYOUT	16-12	18-6	18-7	18-16	18-420	20-2	22-7	24-52
# OF CONTACTS	1-#4	1-#4	1-#8	1-#12	1-#12	1-#0	1-#0	1-#12
SERIES	● ⊕ ⊙ ▼	● ⊕ ▼	⊕ ⊙ ▼	● ⊕ ⊙ ▼	⚡	● ⊙ ■ ▼	● ⊕ ▼	● ⊙
SERVICE RATING	A	D	B	C	17 KVac 24 KVdc	D	E	21 KVac 30 KVdc

2 CONTACTS

									
LAYOUT	10SL-4*	12S-3*	12S-6	14S-9*	16S-4	16A11	16-11	16-13	18-3
# OF CONTACTS	2-#16	2-#16	2-#16	2-#16	2-#16	2-#12	2-#12	2-#12	2-#12
SERIES	● ⊕ ⊙ ▼ ⚡	⊕ ▼ ⚡	⚡	● ⊕ ⊙ ▼ ⚡	● ⊕ ⊙ ▼ ⚡	■	● ⊕ ⊙ ▼ ⚡	⊕ ▼ ⚡	● ⊕
SERVICE RATING	A	A	Thermocouple	A	D	A	A	Thermocouple	D
									
LAYOUT	18-14	20-12	20-23	22-1	22-8	22-11	24-1	24-1	24-1
# OF CONTACTS	1-#16; 1-#4	1-#16; 1-#4	2-#8	2-#8	2-#12	2-#16	1-#12; 1-#0	1-#12; 1-#0	1-#12; 1-#0
SERIES	⊕ ▼	⊕	● ⊕	● ⊕	● ⊕	● ⊕ ▼	▼	▼	▼
SERVICE RATING	A	A	A	D	E	B	D	D	

3 CONTACTS

								
LAYOUT	24-9	28-7	32-5	10SL-3*	14S-1	14S-7	14S-12	16S-5
# OF CONTACTS	2-#4	2-#4	2-#0	3-#16	3-#16	3-#16	3-#16	3-#16
SERIES	● ⊕ ⊙	● ⊙	● ⊕	● ⊕ ⊙ ▼	⊕ ⊙ ▼	● ⊕ ⊙ ▼	● ⊙ ▼	● ⊕
SERVICE RATING	A	D	D	A	A	A	A	A

* most popular * Pins in receptacle, sockets in plug only for 97/AIT/MS series

LAYOUTS BY NUMBER OF CONTACTS

CONTACT LEGEND ⊕ =16 ● =12 ⊙ =8 ○ =4 ⊗ =0 ◐ =2/0 SERIES KEY: AIB (●=GT) AIT (⊕=MS; ⊕=non QPL) 97 (⊕=97)
 Mating face view of pin inserts VG95234 (■) MS3450 (▼=MS; ▽=non QPL) Thermocouple (⊕)

3 CONTACTS (CONT.)

LAYOUT	16S-6	16-7	16-10	18-5	18-22	20-3	20-6	20-19
# OF CONTACTS	3-#16	2-#16; 1-#8	3-#12	1-#16; 2-#12	3-#16	3-#12	3-#16	3-#8
SERIES	● ⊕ ⊕	● ⊕ ⊕ ▽	● ⊕ ⊕ ▽	● ⊕ ⊕ ▽	● ⊕ ⊕ ▽	● ⊕ ⊕	● ⊕ ⊕	● ⊕ ⊕ ▽
SERVICE RATING	A	A	A	D	D	D	D	A

LAYOUT	20-51	20-59	22-2	22-6	22-9	22-21	22-80	28-3
# OF CONTACTS	3-#8	3-#8 for #10 or #12 wire	3-#8	1-#16; 2-#8	3-#12	2-#16; 1-#0	3-#8 for #10 or 12 wire	3-#8
SERIES	● ⊕	● ⊕	● ⊕ ⊕ ▽	● ⊕ ▽	● ⊕ ▽	● ⊕ ▽	● ⊕	● ⊕ ▽
SERVICE RATING	A	A	D	D	E	A	A	E

4 CONTACTS

LAYOUT	28-6	28-72	36-4	40-AV	12SL-844	14S-2*	14S-10
# OF CONTACTS	3-#4	3-#4 (coax) RG-59A/U or RG-62A/U	3-#0	3-#2/0	4-#16	4-#16	4-#16
SERIES	● ⊕ ⊕	● ⊕	● ⊕	● ⊕	⊕	● ⊕ ⊕ ▽	● ⊕ ⊕ ▽
SERVICE RATING	D	(coax)	D(A); A(B,C)	D	I	I	I

LAYOUT	16-9	16-59	18-4*	18-10*	18-13	18-15	20-4*	20-20	20-24
# OF CONTACTS	2-#16; 2-#12	4-#12	4-#16	4-#12	3-#12; 1-#8	4-#12	4-#12	3-#12; 1-#4	2-#16; 2-#8
SERIES	● ⊕ ⊕ ▽	● ⊕	● ⊕ ⊕ ▽	● ⊕ ⊕ ▽	● ⊕ ⊕ ▽	● ⊕ ⊕ ▽	● ⊕ ⊕ ▽	● ⊕	● ⊕ ⊕ ▽
SERVICE RATING	A	A	D	A	A	Thermocouple	D	A	A

LAYOUT	22B22	22-4	22-10	22-22*	24-4	24-22*	32-17
# OF CONTACTS	4-#8	2-#12; 2-#8	4-#16	4-#8	3-#16; 1-#0	4-#8	4-#4
SERIES	■	● ⊕ ⊕ ▽	● ⊕ ⊕ ▽	● ⊕ ⊕ ▽	▽	● ⊕ ⊕ ▽	● ⊕ ⊕ ▽
SERVICE RATING	A	A	E	A	D	D	D

* most popular

LAYOUTS BY NUMBER OF CONTACTS

CONTACT LEGEND ⊕=16 ●=12 ⊙=8 ○=4 ⊗=0
 Mating face view of pin inserts

SERIES KEY: AIB (●=GT) AIT (⊕=MS; ⊙=non QPL) 97 (⊕=97)
 VG95234 (■) MS3450 (▼=MS; ▽=non QPL) Thermocouple (⊕)

4 CONTACTS (CONT.)

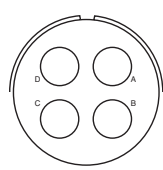

LAYOUT 32-58
 # OF CONTACTS 4-#4 (coax) RG-161/U
 or RG-179/U
 SERIES ● ⊙
 SERVICE RATING (coax)

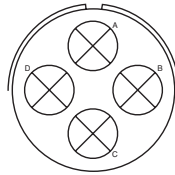

LAYOUT 36-5
 # OF CONTACTS 4-#0
 SERIES ● ⊕ ⊙ ▣ ▼
 SERVICE RATING A

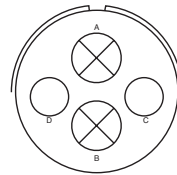

LAYOUT 36-51
 # OF CONTACTS 2-#4; 2-#0
 SERIES ● ⊙
 SERVICE RATING D

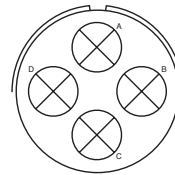

LAYOUT 36-64
 # OF CONTACTS 4-#0 (coax) RG-11/U;
 RG-12/U or RG-13/U
 SERIES ● ⊙
 SERVICE RATING (coax)

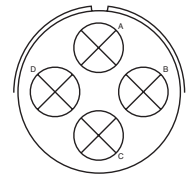

LAYOUT 36-65
 # OF CONTACTS 4-#0 (coax) RG-59/U;
 RG-62/U or RG-71/U
 SERIES ● ⊙
 SERVICE RATING (coax)

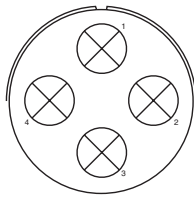

LAYOUT 40-57
 # OF CONTACTS 4-#0
 SERIES ● ⊙
 SERVICE RATING E

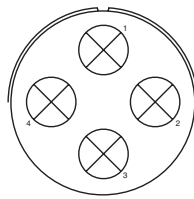

LAYOUT 40-66
 # OF CONTACTS 4-#0 (coax) RG-63B/U
 SERIES ● ⊙
 SERVICE RATING (coax)

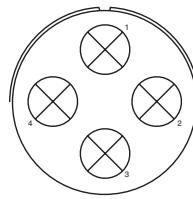

LAYOUT 40-86
 # OF CONTACTS 4-#0 (coax) RG-115A/U
 SERIES ● ⊙
 SERVICE RATING E/ (coax)

5 CONTACTS



LAYOUT 14S-5*
 # OF CONTACTS 5-#16
 SERIES ● ⊕ ⊙ ▼
 SERVICE RATING I



LAYOUT 16S-8*
 # OF CONTACTS 5-#16
 SERIES ● ⊕ ⊙ ▼
 SERVICE RATING A



LAYOUT 18-11*
 # OF CONTACTS 5-#12
 SERIES ● ⊕ ⊙ ▼ ▣
 SERVICE RATING A



LAYOUT 18-20
 # OF CONTACTS 5-#16
 SERIES ● ⊕ ⊙
 SERVICE RATING A



LAYOUT 18-29
 # OF CONTACTS 5-#16
 SERIES ● ⊕ ⊙
 SERVICE RATING A

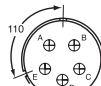

LAYOUT 18-30
 # OF CONTACTS 5-#16
 SERIES ● ⊙ ⊕
 SERVICE RATING A

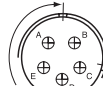

LAYOUT 18-31
 # OF CONTACTS 5-#16
 SERIES ● ⊙ ⊕
 SERVICE RATING A



LAYOUT 20-14
 # OF CONTACTS 3-#12; 2-#8
 SERIES ● ⊕ ⊙ ▼
 SERVICE RATING A

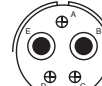

LAYOUT 22-12
 # OF CONTACTS 3-#16; 2-#8
 SERIES ● ⊕ ⊙ ▣
 SERVICE RATING D



LAYOUT 22-13
 # OF CONTACTS 1-#16; 4-#12
 SERIES ● ⊕ ⊙
 SERVICE RATING D(E) A(A,B,C,D)

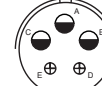

LAYOUT 22-34
 # OF CONTACTS 2-#16; 3-#12
 SERIES ⊕ ⊙
 SERVICE RATING D



LAYOUT 24-12
 # OF CONTACTS 3-#12; 2-#4
 SERIES ● ⊕ ⊙ ▣ ▼
 SERVICE RATING A



LAYOUT 24-17
 # OF CONTACTS 3-#16; 2-#12
 SERIES ● ⊕
 SERVICE RATING D



LAYOUT 24-51
 # OF CONTACTS 5-#8
 SERIES ● ⊙
 SERVICE RATING A



LAYOUT 24-53
 # OF CONTACTS 5-#8
 SERIES ● ⊙
 SERVICE RATING A



LAYOUT 24-79
 # OF CONTACTS 5-#8
 SERIES ● ⊙
 SERVICE RATING A



LAYOUT 28-5
 # OF CONTACTS 2-#16; 1-#12; 2-#4
 SERIES ● ⊕ ⊙ ▼
 SERVICE RATING D

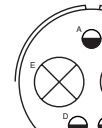

LAYOUT 32-1
 # OF CONTACTS 3-#12; 2-#0
 SERIES ⊕ ▣ ▼
 SERVICE RATING E(A); D(All others)

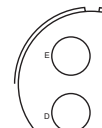

LAYOUT 32-2
 # OF CONTACTS 2-#16; 3-#4
 SERIES ● ⊕ ▼
 SERVICE RATING E

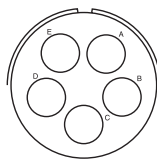

LAYOUT 32-63
 # OF CONTACTS 5-#4
 SERIES ▼
 SERVICE RATING D

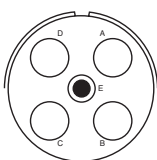

LAYOUT 32-79
 # OF CONTACTS 1-#8; 4-#4
 SERIES ● ⊙
 SERVICE RATING D

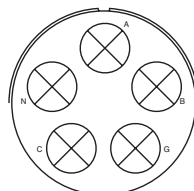

LAYOUT 40-5
 # OF CONTACTS 5-#0
 SERIES ● ⊙
 SERVICE RATING A

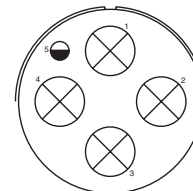

LAYOUT 40-75
 # OF CONTACTS 4-#0; 1-#12
 SERIES ● ⊙
 SERVICE RATING E

6 CONTACTS



LAYOUT 14S-6*
 # OF CONTACTS 6-#16
 SERIES ● ⊕ ⊙ ▣ ▼
 SERVICE RATING I

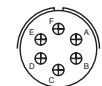

LAYOUT 18-12
 # OF CONTACTS 6-#16
 SERIES ⊕ ⊙ ▼ ▣
 SERVICE RATING A

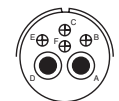

LAYOUT 20-8
 # OF CONTACTS 4-#16; 2-#8
 SERIES ● ⊕ ⊙ ▣ ▼
 SERVICE RATING I

* most popular

LAYOUTS BY NUMBER OF CONTACTS

CONTACT LEGEND ⊕ =16 ● =12 ⊙ =8 ○ =4 ⊗ =0
Mating face view of pin inserts

SERIES KEY: AIB (●=GT) AIT (⊕=MS; ⊙=non QPL) 97 (⊕=97)
VG95234 (■) MS3450 (▼=MS; ▽=non QPL) Thermocouple (⊕)

6 CONTACTS (CONT.)

LAYOUT	20-17	20-22	20-66	22-5	22-15	22-24	28-22	28-82
# OF CONTACTS	1-#16; 5-#12	3-#16; 3-#8	1-#16; 5-#12 for #10 wire	4-#16; 2-#12	1-#16; 5-#12	4-#16; 2-#12	3-#16; 3-#4	4-#12; 2-#8
SERIES	● ⊕ ⊕ ▼	● ⊕ ▼	● ⊙	● ⊕ ⊕ ▼ ⊕	● ⊕ ⊕ ■ ▼	● ⊕	● ⊕ ■ ▼	● ⊙
SERVICE RATING	A	A	A	D	A(A, B, C, E, F); E(D)	D(C, D, E)A(A, B, F)	D	D

7 CONTACTS

LAYOUT	36-3	36-6	40-74	14SA7	16S-1*	18-9	18-17
# OF CONTACTS	3-#12; 3-#0	4-#4; 2-#0	1-#12; 1-#4 (coax) RG-62/U; 4-#0 (coax) RG-9B/U or RG-214/U	7-#16	7-#16	5-#16; 2-#12	5-#16; 2-#12
SERIES	● ⊕ ⊕ ▼	● ⊕ ⊕ ■ ▼	● ⊙	● ⊙	● ⊕ ⊕ ■ ▼ ⊕	● ⊕ ⊕ ■ ▼ ⊕	● ⊙ ⊕ ▼
SERVICE RATING	D	A	A / coax	A	A	I	I

LAYOUT	20-15*	20-57	22-26	22-28	22-33	24-2	24-3
# OF CONTACTS	7-#12	7-#12 for #14 or 16 wire	5-#16; 2-#12	7-#12	7-#16	7-#12	5-#16; 2-#12
SERIES	● ⊕ ⊕ ▼ ⊕	● ⊙	⊕	● ⊕	● ⊕	● ⊕ ⊕ ▼	● ⊕
SERVICE RATING	A	A	1/8" spacing	D/A	D(A, B, C, D); A(E, F, G)	D	D

LAYOUT	24-10	24-16	24-27	24-60	24-66	24-71	24-75
# OF CONTACTS	7-#8	3-#16; 3-#12; 1-#8	7-#16	7-#8 or 12 wire	7-#12	5-#8 for #10 or 12 wire, 2-#8	2-#8 for #16 wire; 5-#8
SERIES	● ⊕ ⊕ ■ ▼	● ⊕ ⊕ ▼	● ⊕ ⊕ ▼	● ⊙	● ⊙	● ⊙	● ⊙
SERVICE RATING	A	D(A, B, F, G) A(C, D, E)	E	A	D	A	A

LAYOUT	28-10	32-10	36-73	36-77	36-83	40-87
# OF CONTACTS	3-#12; 2-#8; 2-#4	3-#16; 2-#8; 2-#4	7-#4 (coax) RG-62B/U	7-#4	7-#4 (coax) RG-58/U	7-#4
SERIES	● ⊕ ⊕ ▼	● ⊕	● ⊙	● ⊙	● ⊙	● ⊙
SERVICE RATING	D(G); A(All others)	E(A, F); B(G); D(B, E); A(C, D)	(coax)	D	(coax)	D

* most popular

LAYOUTS BY NUMBER OF CONTACTS

CONTACT LEGEND ⊕=16 ●=12 ⊙=8 ○=4 ⊗=0
 Mating face view of pin inserts

SERIES KEY: AIB (●=GT) AIT (⊕=MS; ⊕≠non QPL) 97 (⊕=97)
 VG95234 (■) MS3450 (▼=MS; ▼≠non QPL) Thermocouple (⊕)

8 CONTACTS



LAYOUT	18-8*	20-7*	20-9	20-79	22-18	22-23	22-36	22-65
# OF CONTACTS	7-#16; 1-#12	8-#16	7-#16; 1-#12	7-#16; 1-#12 for #16 wire	8-#16	8-#12	8-#12	8-#12 for #14 or 16 wire
SERIES	● ⊕ ⊕ ▼	● ⊕ ⊕ ▼ ⊕	⊕ ⊕ ▼	⊕ ⊕	● ⊕ ⊕ ▼	● ⊕ ⊕ ▼	▼	● ⊕
SERVICE RATING	A	A (B,C,F,G); I(all others)	DCH; A(all others)	DCH; A(all others)	D(A, B, F, G, H); A(C, D, E)	D(H); A(all others)	D(H)	D(H); A(all others)

9 CONTACTS

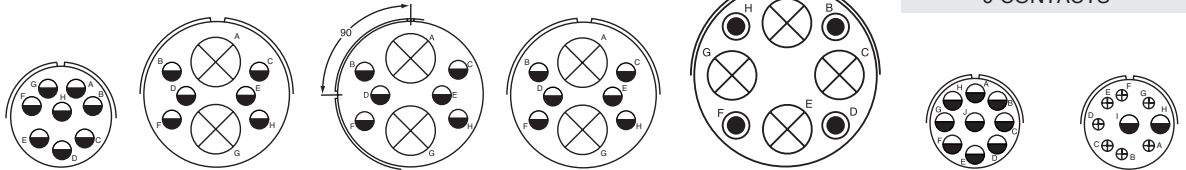

LAYOUT	24-6	32-15	32-52	32-57	40-AD	20A9	20-16
# OF CONTACTS	8-#12	6-#12; 2-#0	6-#12; 2-#0	6-#12; 2-#0 (coax) RG-7/U	4-#8; 4-#0	9-#12	7-#16; 2-#12
SERIES	● ⊕ ⊕ ▼	● ⊕ ▼	● ⊕	● ⊕	● ⊕	■	● ⊕ ⊕ ▼
SERVICE RATING	D(A, G, H); A(all others)	D	D	(coax)	A	D(J), I(all others)	A

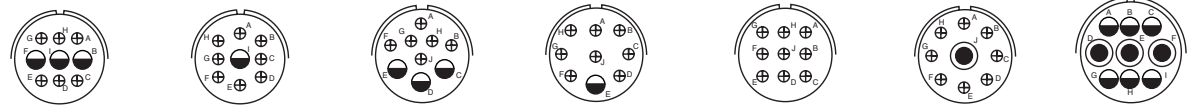

LAYOUT	20-18*	20-21	22-16	22-17	22-20	22-27	24-11
# OF CONTACTS	6-#16; 3-#12	8-#16; 1-#12	6-#16; 3-#12	8-#16; 1-#12	9-#16	8-#16; 1-#8	6-#12; 3-#8
SERIES	● ⊕ ⊕ ▼	● ⊕ ⊕ ▼	● ⊕ ⊕ ▼	● ⊕ ▼	● ⊕ ⊕	● ⊕ ⊕ ▼	● ⊕ ⊕ ▼
SERVICE RATING	A	A	A	D(A); A(all others)	A	D(J); A(all others)	A

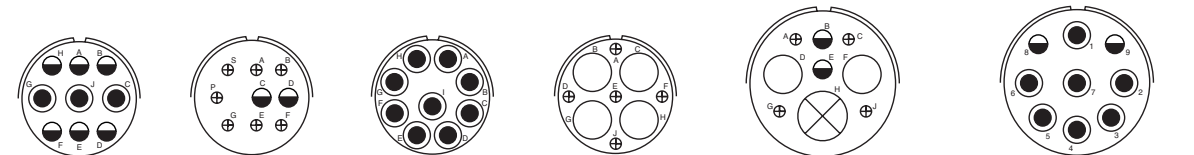

LAYOUT	28-1	28-4	28-84	28AY	32-3	32-75
# OF CONTACTS	6-#12; 3-#8	7-#16; 2-#12	9-#8	5-#16; 4-#4	4-#16; 2-#12; 2-#4; 1-#0	2-#12; 7-#8 (coax) RG-180B/U
SERIES	● ⊕ ⊕ ▼	● ⊕ ▼	● ⊕	● ⊕	● ⊕ ▼	● ⊕
SERVICE RATING	D(A, J, E); A(all others)	E(G, P, S); D(all others)	A	A	D	(coax)

10 CONTACTS



LAYOUT	18-1*	18-19	18-24	20-58	24-21	28-19
# OF CONTACTS	10-#16	10-#16	10-#16	5-#16; 5-#12	9-#16; 1-#8	6-#16; 4-#12
SERIES	● ⊕ ⊕ ▼ ⊕	● ⊕ ⊕ ▼	● ⊕ ⊕ ▼	● ⊕	● ⊕ ⊕ ▼	● ⊕ ⊕ ▼
SERVICE RATING	A (B, C, F, G); I(all others)	A	A(B, C, F, G); I(balance)	A	D	B(H, M); D(A, B) A(C, E, G, J, K, L)

* most popular

LAYOUTS BY NUMBER OF CONTACTS

CONTACT LEGEND ⊕ =16 ⊖ =12 ⊙ =8 ○ =4 ⊗ =0
Mating face view of pin inserts

SERIES KEY: AIB (●=GT) AIT (⊕=MS; ⊖=non QPL) 97 (◆=97)
VG95234 (■) MS3450 (▼=MS; ▽=non QPL) Thermocouple (⊞)

11 CONTACTS

LAYOUT 20-33	LAYOUT 24-20	LAYOUT 36-14	LAYOUT 40-67	LAYOUT 40-72	LAYOUT 40-80
# OF CONTACTS 11-#16	9-#16; 2-#12	6-#16; 5-#12; 5-#8	1-#16; 10-#4 (coax) RG-59/U	1-#16; 10-#4 (coax) RG-9B/U	10-#4; 1-#16
SERIES ● ⊕ ◆ ▼	● ⊕ ◆ ▼ ⊞	● ⊕	● ◆	● ◆	● ◆
SERVICE RATING A	D	D	A (coax)	A (coax)	A

12 CONTACTS

LAYOUT 22-63	LAYOUT 24-19	LAYOUT 28-8	LAYOUT 28-9	LAYOUT 28-18	LAYOUT 28-51
# OF CONTACTS 8-#16; 4-#12	12-#16	10-#16; 2-#12	6-#16; 6-#12	12-#16	12-#12
SERIES ● ◆	● ⊕	● ⊕ ◆ ▽	● ⊕ ◆ ▼	● ⊕ ◆ ▽	● ◆
SERVICE RATING A	A	E(L,M,); D(B) A(balance)	D	C(M); D(G, H, J, K, L) A(A, B); I(C,D,E,F)	A

13 CONTACTS

LAYOUT 20-11	LAYOUT 20-25	LAYOUT 20-30	LAYOUT 22-70	LAYOUT 24-58	LAYOUT 32-14	LAYOUT 20-27*
# OF CONTACTS 13-#16	13-#16	13-#16	5-#16; 8-#12	7-#16; 3-#12; 3-#8	13-#12	14-#16
SERIES ● ⊕ ◆	● ◆ ◆	● ◆ ◆	● ◆	● ◆	◆	● ⊕ ◆ ▼ ⊞
SERVICE RATING I	I	I	A	A	D	A

14 CONTACTS

LAYOUT 22-19*	LAYOUT 24-59	LAYOUT 28-2	LAYOUT 28-20	LAYOUT 32-4	LAYOUT 32-9	LAYOUT 36-78
# OF CONTACTS 14-#16	7-#16; 7-#12	12-#16; 2-#12	4-#16; 10-#12	12-#16; 2-#12	12-#16; 2-#4	12-#8; 2-#16
SERIES ● ⊕ ◆ ▼ ⊞	● ◆	● ⊕ ◆ ▼	● ⊕ ◆ ▼ ⊞	● ⊕	● ⊕ ▼	● ◆
SERVICE RATING A	A	D	A	A(F, J, K, N); D(all others)	D	A

• different per 1651 STD: 5-#12; 2-#4

* most popular

LAYOUTS BY NUMBER OF CONTACTS

CONTACT LEGEND ⊕=16 ●=12 ⊙=8 ○=4 ⊗=0
 Mating face view of pin inserts

SERIES KEY: AIB (●=GT) AIT (⊕=MS; ⊕=non QPL) 97 (⊕=97)
 VG95234 (■) MS3450 (▼=MS; ▼=non QPL) Thermocouple (⊕)

15 CONTACTS

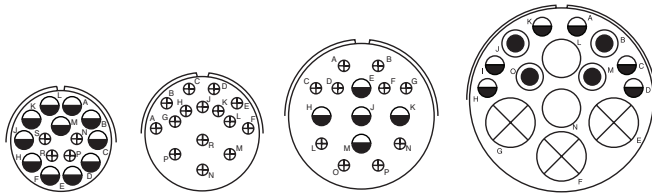

LAYOUT	24-65	28-17*	32-12	40-5□
# OF CONTACTS	4-#16; 11-#12	15-#16	10-#16; 5-#12	6-#12; 4-#8; 2-#4; 3-#0
SERIES	● ⊕	● ⊕ ⊕ ▼	● ⊕	▼
SERVICE RATING	A	B(R); D(M-P); A(A-L)	A(C, D, E, F, G); D(all others)	A

16 CONTACTS

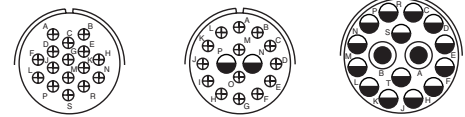

LAYOUT	24-5	24-7*	28-66
# OF CONTACTS	16-#16	14-#16; 2-#12	14-#12; 2-#8
SERIES	● ⊕ ▼ ⊕	● ⊕ ▼ ⊕	● ⊕
SERVICE RATING	A	A	A

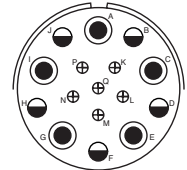
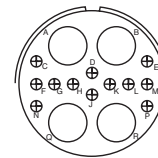
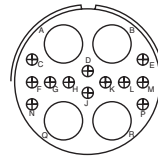
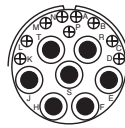

LAYOUT	28-74	28-75	28-79	32-68	32-82	36-14
# OF CONTACTS	9-#16; 4-#8; 3-#8 for #10 wire	9-#16; 7-#8 for #10 wire	7-#8; 9-#16	12-#12; 4-#4 (coax)	12-#16; 4-#4	6-#16; 5-#12; 5-#8
SERIES	● ⊕	● ⊕	● ⊕	● ⊕	● ⊕	● ⊕
SERVICE RATING	A	A	A	A (coax)	A	D

17 CONTACTS

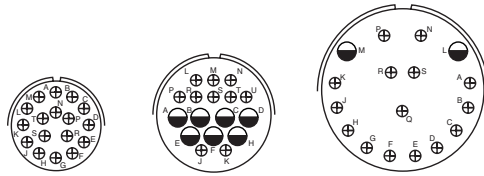

LAYOUT	20-29*	28-59	36-13
# OF CONTACTS	17-#16	10-#16; 7-#12	15-#16; 2-#12
SERIES	● ⊕ ▼ ⊕	● ⊕	● ⊕
SERVICE RATING	A	A	E(N, P, Q); A(all others)

19 CONTACTS



LAYOUT	20A48	20-26	22-14*	24-67
# OF CONTACTS	19-#16	19-#16	19-#16	19-#12
SERIES	■	⊕ ●	● ⊕ ⊕ ▼ ⊕	● ⊕
SERVICE RATING	I	A	A	I

20 CONTACTS

21 CONTACTS

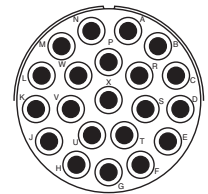
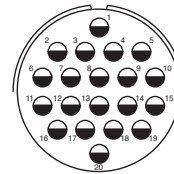
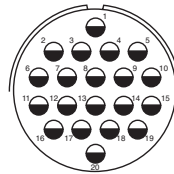
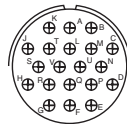
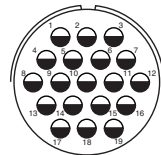
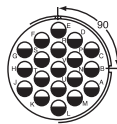

LAYOUT	24-84	32-76	28-16	36-79	36-80	40-68
# OF CONTACTS	1-#12; 18-#12 (coax)	19-#12,	20-#16	20-#12	20-#12 for #10 wire	21-#8
SERIES	● ⊕	● ⊕	● ⊕ ▼ ⊕	● ⊕	● ⊕	● ⊕
SERVICE RATING	A (coax)	A	A	A	A	A

* most popular

□ Special arrangement for MS3450 Series

LAYOUTS BY NUMBER OF CONTACTS

CONTACT LEGEND ⊕=16 ⊖=12 ●=8 ○=4 ⊗=0
Mating face view of pin inserts

SERIES KEY: AIB (●=GT) AIT (⊕=MS; ⊖=non QPL) 97 (◆=97)
VG95234 (■) MS3450 (▼=MS; ▽=non QPL) Thermocouple (⊖)

22 CONTACTS

23 CONTACTS

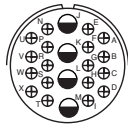

28-11*

18-#16; 4-#12



A

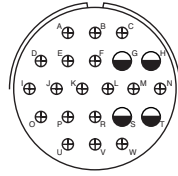

36-1

18-#16, 4-#12



D

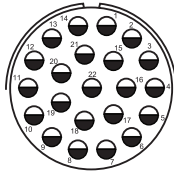

36-22

22-#12



D

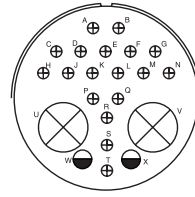

40-7

18-#16; 2-#12; 2-#0



P, Q, U, V, W, X=A;
D(balance)

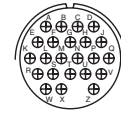

24-80

23-#16



I

LAYOUT
OF CONTACTS
SERIES
SERVICE RATING

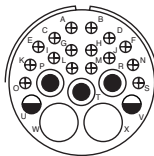

32-6

16-#16; 2-#12;
3-#8; 2-#4



A

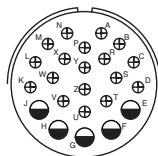

32-13

18-#16; 5-#12



D

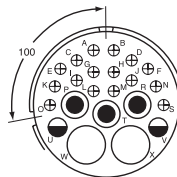

32-16

16-#16; 2-#12;
3-#8; 2-#4



A

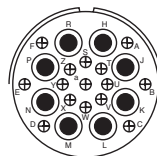

32-60

15-#16; 8-#8 (coax)
RG-124/U



A (coax)

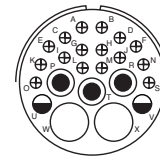

32-62

16-#16; 2-#12; 1-#8;
2-#8 (coax) RG-124/U; 2-#4



A (coax)

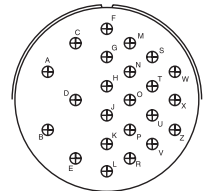

40-2

23-#16



D

LAYOUT
OF CONTACTS
SERIES
SERVICE RATING

23 CONTACTS (CONT.)

24 CONTACTS

25 CONTACTS

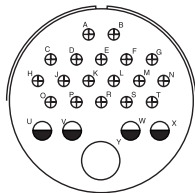

40-3

18-#16; 4-#12; 1-#4



D

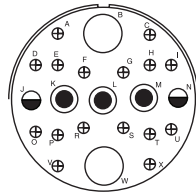

40-4

16-#16; 2-#12; 3-#8; 2-#4



D

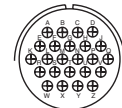

24-28*

24-#16



I

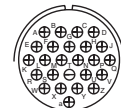

24-AJ

25-#16



A

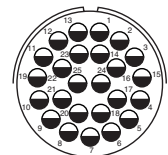

32-25

25-#12



A

LAYOUT
OF CONTACTS
SERIES
SERVICE RATING

26 CONTACTS

28 CONTACTS

29 CONTACTS

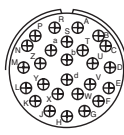

28-12*

26-#16



A

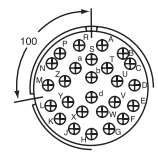

28-13

26-#16



A

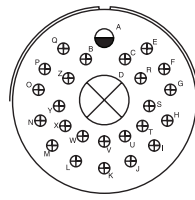

40-6

24-#16; 1-#12; 1-#0



D

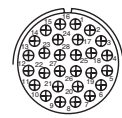

24-96

28-#16



I

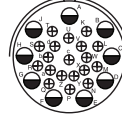

28A63

19-#16; 9-#12



A

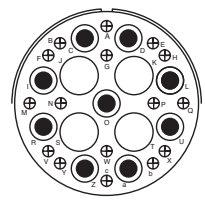

40-10

16-#16; 9-#8; 4-#4



A

LAYOUT
OF CONTACTS
SERIES
SERVICE RATING

* most popular

LAYOUTS BY NUMBER OF CONTACTS

CONTACT LEGEND ⊕=16 ●=12 ⊙=8 ○=4 ⊗=0
 Mating face view of pin inserts

SERIES KEY: AIB (●=GT) AIT (⊕=MS; ⊖=non QPL) 97 (⬠=97)
 VG95234 (■) MS3450 (▼=MS; ▽=non QPL) Thermocouple (⊖)

30 CONTACTS

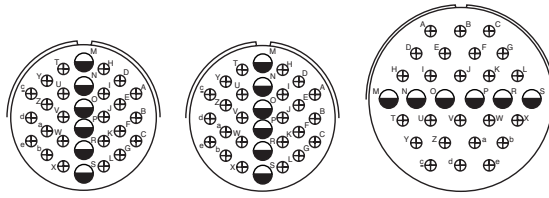

32-8

24-#16; 6-#12

● ⊕ ⊖

A

32-56

24-#16; 6-#12 for #10 wire

● ⊖

A

40-1

24-#16; 6-#12

● ⊕ ▼

D

31 CONTACTS

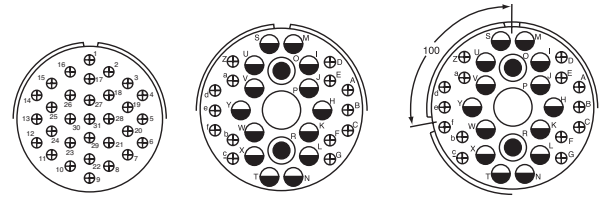

32-31

31-#16

● ⊖

A

36-9

14-#16; 14-#12; 2-#8; 1-#4

● ⊕ ⊖ ▼

A

36-18

14-#16; 14-#12; 2-#8; 1-#4

● ⊖ ▽

A

LAYOUT
 # OF CONTACTS
 SERIES
 SERVICE RATING

34 CONTACTS

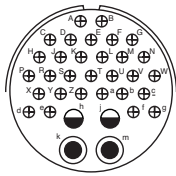

36-20

30-#16; 2-#12; 2-#8

● ⊖

A

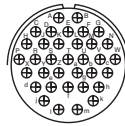

28-15*

35-#16

● ⊕ ▼ ▽

A

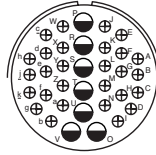

32-7*

28-#16; 7-#12

● ⊕ ⊖ ■ ▼

I(A, B, H, J); A(all others)

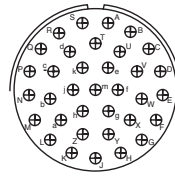

36-15

35-#16

● ⊕ ▼ ▽

D(M); A(balance)

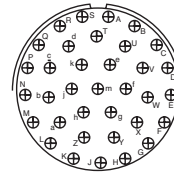

36-85

35-#16 for #12 wire

● ⊖

A/D

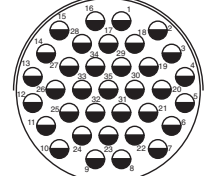

40-35

35-#12

● ⊖

D

LAYOUT
 # OF CONTACTS
 SERIES
 SERVICE RATING

36 CONTACTS

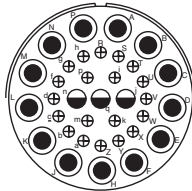

40-64

20-#16; 3-#12; 13-#8 (coax) RG-124/U

● ⊖

(coax)

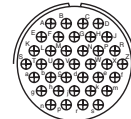

28-21*

37-#16

● ⊕ ▼ ▽

A

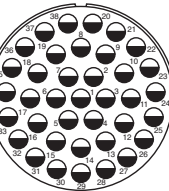

40-AG

38-#12

● ⊖

A

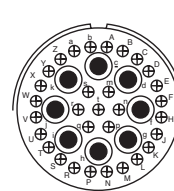

36-54

31-#16; 8-#8

● ⊖

A

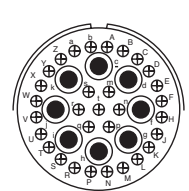

36-55

31-#16; 8-#8 for #6 wire

● ⊖

A

LAYOUT
 # OF CONTACTS
 SERIES
 SERVICE RATING

42 CONTACTS

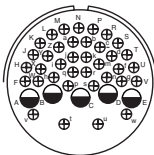

32-53

37-#16; 5-#12

● ⊖

I/E

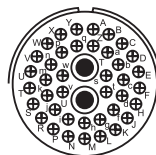

32-59

40-#16; 2-#8 (coax) RG-161/U

● ⊖

A (coax)

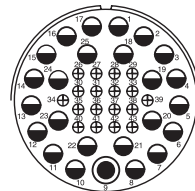

40-AT

18-#16; 24-#12; 1-#8

● ⊖

A

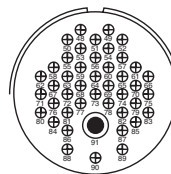

36-74

43-#16; 1-#8 (coax); RG-187B/U

● ⊖

A (coax)

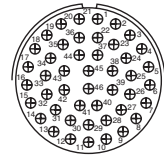

32-73

46-#16

● ⊖ ▼

A

LAYOUT
 # OF CONTACTS
 SERIES
 SERVICE RATING

* most popular

LAYOUTS BY NUMBER OF CONTACTS

CONTACT LEGEND ⊕=16 ●=12 ⊙=8 ○=4 ⊗=0
Mating face view of pin inserts

SERIES KEY: AIB (●=GT) AIT (⊕=MS; ⊕=non QPL) 97 (⬠=97)
VG95234 (■) MS3450 (▼=MS; ▼=non QPL) Thermocouple (⊕)

47 CONTACTS

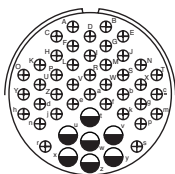

36-7*

40-#16; 7-#12

● ⊕ ▼ ⊕

A

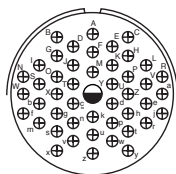

36-8

46-#16; 1-#12

● ⊕ ▼ ⊕

A

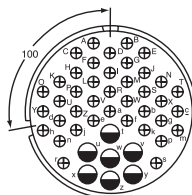

36-16

40-#16; 7-#12

● ⊕ ▼

A

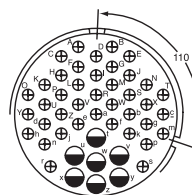

36-17

40-#16; 7-#12

● ⊕ ▼

A

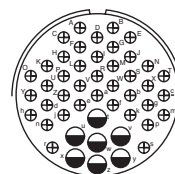

36-60

40-#16; 7-#12 for #10 wire

● ⊕

A

LAYOUT
OF CONTACTS
SERIES
SERVICE RATING

48 CONTACTS

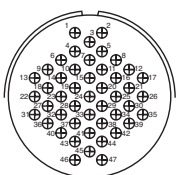

36-76

47-#16

● ⊕

A

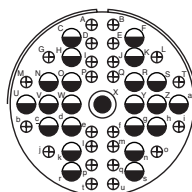

40-9

24-#16; 22-#12; 1-#8

● ⊕ ▼

A

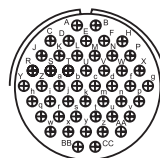

32-48

48-#16

● ⊕

I

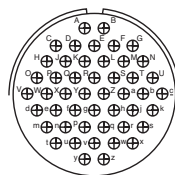

36-10*

48-#16

● ⊕ ⊕ ▼ ⊕

A

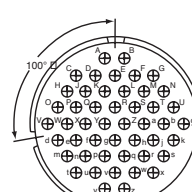

36-11

48-#16

● ⊕ ⊕ ▼

A

LAYOUT
OF CONTACTS
SERIES
SERVICE RATING

52 CONTACTS

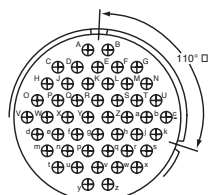

36-12

48-#16

● ⊕ ⊕ ▼

A

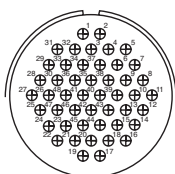

36-75

48-#16 for #14 wire

● ⊕

A

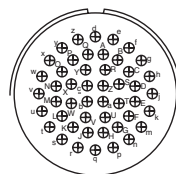

36-AF

48-#16

● ⊕

A

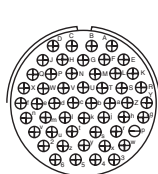

32-414

52-#16

⬠

A

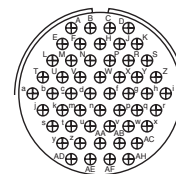

36-52

52-#16

● ⊕ ▼ ⊕

A

LAYOUT
OF CONTACTS
SERIES
SERVICE RATING

53 CONTACTS

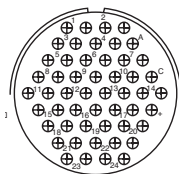

36-403

52-#16

⬠

A

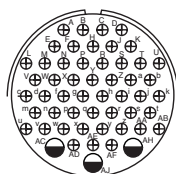

36-59

50-#16; 3-#12 for #10 wire

● ⊕

A

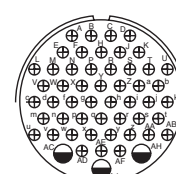

36-71

50-#16; 3-#12

● ⊕

A

LAYOUT
OF CONTACTS
SERIES
SERVICE RATING

* most popular

LAYOUTS BY NUMBER OF CONTACTS

CONTACT LEGEND $\oplus=20$ $\opl�=16$ $\ominus=12$ $\bullet=8$ $\circ=4$ $\otimes=0$ SERIES KEY: AIB ($\bullet=GT$) AIT ($\oplus=MS$; $\opl�=non\ QPL$) 97 ($\diamond=97$)
 Mating face view of pin inserts VG95234 (\blacksquare) MS3450 ($\blacktriangledown=MS$; $\blacktriangledown=non\ QPL$) Thermocouple (Ⓢ)

54 CONTACTS

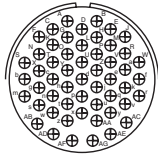

LAYOUT

32-22

OF CONTACTS
 SERIES
 SERVICE RATING

54-#16
 \bullet $\opl�$ \blacktriangledown
 A

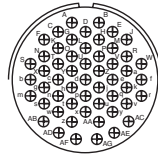

LAYOUT

32-64

54-#16
 \bullet $\opl�$
 I

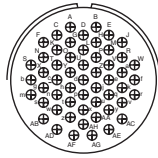

LAYOUT

32-AF

55-#16
 \bullet $\opl�$
 A

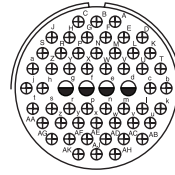

LAYOUT

36-66

52-#16; 4-#12
 \blacktriangledown
 A

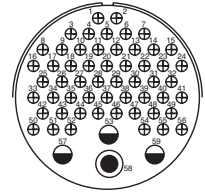

LAYOUT

40-61

55-#16; 3-#12; 1-8
 \bullet $\opl�$
 A

60 CONTACTS

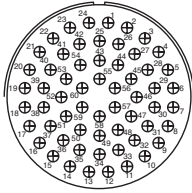

LAYOUT

40-53

OF CONTACTS
 SERIES
 SERVICE RATING

60-#16
 \bullet $\opl�$ Ⓢ
 A

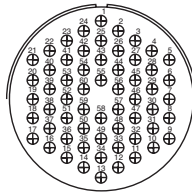

LAYOUT

40-62

60-#16
 \bullet \oplus \blacktriangledown
 A

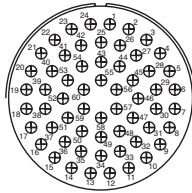

LAYOUT

40-85

60-#16 for #14 wire
 \bullet $\opl�$
 A

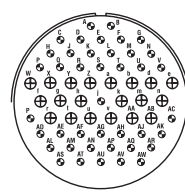

LAYOUT

32A69

41-#20; 20-#16
 \blacksquare
 I

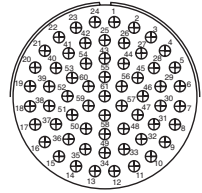

LAYOUT

40-63

61-#16 for #14 wire
 \bullet $\opl�$
 A

62 CONTACTS

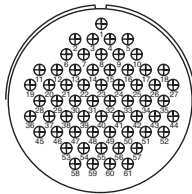

LAYOUT

40-70

OF CONTACTS
 SERIES
 SERVICE RATING

61-#16
 \bullet $\opl�$
 A

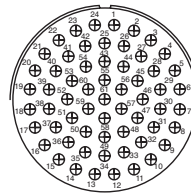

LAYOUT

40-73

61-#16
 \bullet $\opl�$
 A

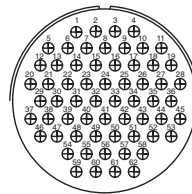

LAYOUT

40-81

62-#16 for #14 wire
 \bullet $\opl�$
 A

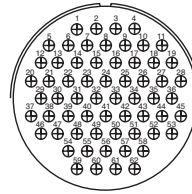

LAYOUT

40-82

62-#16
 \bullet $\opl�$
 A

85 CONTACTS

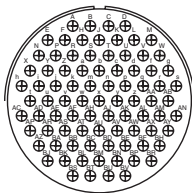

LAYOUT

40-56

OF CONTACTS
 SERIES
 SERVICE RATING

85-#16
 \bullet \oplus \blacktriangledown Ⓢ
 A

* most popular

LAYOUTS BY SHELL SIZE

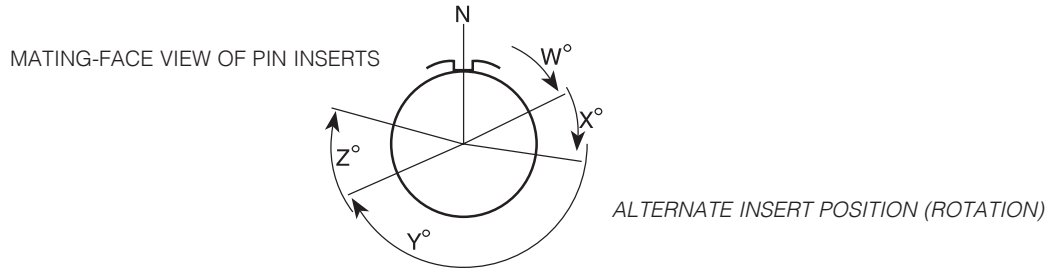

SERIES KEY: 97 (◆=97) AIT (⊕=MS; ◆=non QPL) AIB (●=GT) VG95234 (■) MS3450 (▼=MS; ▽=non QPL) Thermocouple (⊖) CONTACT METALLURGY KEY: Alumel (Al.) Chromel (Ch.) Constantan (Con.) Copper (Cu) Iron (Ir.)

LAYOUT	CONTACTS SIZES					DEGREES OF ROTATION				SERVICE RATING								
	97 Series	AIT Series	AIB/GT	VG95234	MS3450	TOTAL	20	16	12		8	4	0	°	W	X	Y	Z
8S-1	◆	⊕			▼	1		1						-	-	-	-	A
10S-2		⊕^			▼	1		1						-	-	-	-	A
10SL-3	◆*	⊕*	●*	■	▼	3		3						-	-	-	-	A
10SL-4	◆*	⊕^*	●	■	▼	2		2						63#	-	-	-	A
10SL-51		◆*	●		▽	2		2					⊖	10SL-4	45°	A=Ir.; B=Con.		
10SL-52		◆*	●		▽	2		2					⊖	10SL-4	45°	A=Cu; B=Con.		
10SL-53		◆*	●		▽	2		2					⊖	10SL-4	45°	A=Al.; B=Ch.		
10SL-54		◆*	●		▽	3		3					⊖	10SL-3	A=Ir.; B=Con.; C=Cu			
10SL-55		◆*	●		▽	3		3					⊖	10SL-3	A=Al.; B=Ch.; C=Cu			
10SL-56		◆*	●		▽	2		2					⊖	10SL-4	A=Al.; B=Ch.			
10SL-57		◆*	●		▽	2		2					⊖	10SL-4	A=Ch.; B=Con.			
10SL-58		◆*	●		▽	3		3					⊖	10SL-3	A=Ch.; B=Al.; C=Cu			
10SL-59		◆*	●		▽	2		2					⊖	10SL-4	A=Ch.; B=Al.			
10SL-60		◆*	●		▽	2		2					⊖	10SL-4	A=Ir.; B=Con.			
10SL-61		◆*	●		▽	2		2					⊖	10SL-4	A=Cu; B=Con.			
10SL-62		◆*	●		▽	3		3					⊖	10SL-3	A=Cu; B=Al.; C=Ir.			
10SL-63		◆*	●		▽	3		3					⊖	10SL-3	A, C=Con.; B=Ch.			
10SL-64		◆*	●		▽	3		3					⊖	10SL-3	A, C=Ch.; B=Al.			
12S-1		◆			▽	2		2						12S-3	100°			A
12S-2	◆	◆			▽	2		2						12S-3	250°			A
12S-3	◆	⊕			▼	2		2						70	145	215	290	A
12S-4		⊕			▼	1		1						-	-	-	-	D
12S-6	◆					2		2					⊖	12S-3	A=Con.; B=Ir.			
12S-51		◆			▽	2		2					⊖	12S-3	315°	A=Ch.; B=Al.		
12S-54		◆			▽	2		2					⊖	12S-3	315°	A = Ir.; B=Con.		
12S-55		◆			▽	2		2					⊖	12S-3	45°	A=Cu; B=Con.		
12S-56		◆			▽	2		2					⊖	12S-3	A=Al.; B=Ch.			
12S-57		◆			▽	2		2					⊖	12S-3	60°	A=Ch.; B=Al.		
12S-58		◆			▽	2		2					⊖	12S-3	120°	A=Ir.; B=Con.		
12S-59		◆			▽	2		2					⊖	12S-3	A=Ir.; B=Con.			
12S-60		◆			▽	2		2					⊖	12S-3	A=Cu; B=Con.			
12S-61		◆			▽	2		2					⊖	12S-3	A=Ch.; B=Con.			
12S-62		◆			▽	2		2					⊖	12S-3	A=Ch.; B=Al.			
12SL844	◆					4		4						-	-	-	-	I
12-5	◆	⊕			▼	1			1					-	-	-	-	D
14S-1	◆	⊕	●		▼	3		3						-	-	-	-	A
14S-2	◆	⊕	●		▼	4		4						-	120	240	-	I
14S-4	◆	⊕^	●			1		1						-	-	-	-	D
14S-5	◆	⊕	●		▼	5		5						-	110	-	-	I

*Pins in receptacle, sockets in plug only ^ 5015 QPL not all configurations #Rotation commercial only, not MS-approved

NOTE: 16S contacts are used in shell sizes 8S, 10S, 10SL, 12S, 14S, & 16S

LAYOUTS BY SHELL SIZE

SERIES KEY: 97 (◆=97) **AIT** (⊕=MS; ⊖=non QPL) **AIB** (●=GT) **VG95234** (■) **MS3450** (▼=MS; ▽=non QPL) **Thermocouple** (⊖°)

CONTACT METALLURGY KEY: Alumel (Al.) Chromel (Ch.) Constantan (Con.) Copper (Cu) Iron (Ir.)

LAYOUT	97 Series	AIT Series	AIB/GT	VG95234	MS3450	TOTAL	CONTACTS SIZES						⊖°	DEGREES OF ROTATION				SERVICE RATING
							20	16	12	8	4	0		W	X	Y	Z	
14S-6	◆	⊕	●	■	▼	6		6						90#	-	-	-	I
14S-7	◆	⊕	●		▼	3		3						90	180	270	-	A
14S-9	◆	⊕	●		▼	2		2						70	145	215	290	A
14S-10	◆	⊖	●		▽	4		4						14S-2	100°			I
14S-11	◆	⊖	●		▽	4		4						14S-2	250°			I
14S-12	◆	⊖	●		▽	3		3						14S-1	100°			A
14S-13	◆	⊖	●		▽	3		3						14S-1	260°			A
14S-14	◆	⊖	●			4		4						14S-2	100°			I
14S-51		⊖	●		▽	2		2				⊖°	14S-9	90° A=Al.; B=Ch.				
14S-52		⊖	●		▽	4		4				⊖°	14S-2	45° A, B=Cu; C=Al.; D=Ch.				
14S-53		⊖	●		▽	2		2				⊖°	14S-9	90° A=Ir.; B=Con.				
14S-54		⊖	●		▽	6		6				⊖°	14S-6	45° A, C, E=Ir.; B, D, F=Con.				
14S-55		⊖	●		▽	4		4				⊖°	14S-2	45° A, C=Ir.; B, D=Con.				
14S-56		⊖	●		▽	4		4				⊖°	14S-2	45° A=Ir.; B=Con.; C, D=Cu				
14S-57		⊖	●		▽	4		4				⊖°	14S-2	45° A, C=Al.; B, D=Ch.				
14S-58		⊖	●		▽	3		3				⊖°	14S-7	45° A=Al.; B=Ch.; C=Cu				
14S-59		⊖	●		▽	2		2				⊖°	14S-9	90° A=Cu; B=Con.				
14S-60		⊖	●		▽	2		2				⊖°	14S-9	A=Al.; B=Ch.				
14S-61		⊖	●		▽	6		6				⊖°	14S-6	45° A=Al.; B=Ch.; C=Ir.; D=Con.; E, F=Cu				
14S-63		⊖	●		▽	6		6				⊖°	14S-6	A, C= Al.; B, D=Ch.; E=Ir.; F=Con.				
14S-64		⊖	●		▽	4		4				⊖°	14S-2	A, C=Con.; B, D=Cu				
14S-65		⊖	●		▽	6		6				⊖°	14S-6	A, C, E= Cu; B, D, F=Con.				
14S-67		⊖	●		▽	6		6				⊖°	14S-6	A=Al.; B=Ch.; Balance=Cu				
14S-68		⊖	●		▽	4		4				⊖°	14S-2	45° A=Ch.; B=Con.; C, D=Cu				
14S-69		⊖	●		▽	3		3				⊖°	14S-7	A=Con.; B=Ch.; C=Cu				
14S-70		⊖	●		▽	4		4				⊖°	14S-2	A, D=Ch.; B, C=Al.				
14S-71		⊖	●		▽	4		4				⊖°	14S-2	A, B, D=Cu; C=Con.				
14S-72		⊖	●		▽	2		2				⊖°	14S-9	A=Con.; B=Cu				
14S-73		⊖	●		▽	4		4				⊖°	14S-2	A, B=Cu; C=Al.; D=Ch.				
14S-74		⊖	●		▽	4		4				⊖°	14S-2	A, B=Ch.; C, D=Al.				
14S-75		⊖	●		▽	4		4				⊖°	14S-2	A, B=Cu; C, D=Con.				
14S-76		⊖	●		▽	4		4				⊖°	14S-2	A, C=Al.; B, D=Ch.				
14S-77		⊖	●		▽	4		4				⊖°	14S-2	A, D=Al.; B, C=Ch.				
14S-78		⊖	●		▽	2		2				⊖°	14S-9	A=Ch.; B=Al.				
14SA7		⊖	●			7		7					-	-	-	-	A	
14-3		⊕			▼	1			1				-	-	-	-	A	
16S-1	◆	⊕	●	■	▼	7		7					80	-	-	280	A	
16S-3		⊕			▽	1		1					-	-	-	-	B	
16S-4	◆	⊕	●	■	▽	2		2					35	110	250	325	D	
16S-5	◆	⊕	●			3		3					70	145	215	290	A	
16S-6	◆	⊕	●			3		3					90	180	270	-	A	
16S-8	◆	⊕	●		▼	5		5					-	170	265	-	A	
16S-14	◆	⊖	●			3		3					16S-5	110°			A	
16S-15	◆	⊖	●			2		2					16S-4	100°			D	
16S-16	◆	⊖	●			2		2					16S-4	250°			D	
16S-17	◆	⊖	●			3		3					16S-5	250°			A	
16S-52		⊖	●		▽	2		2				⊖°	16S-4	A=Ch.; B= Al.				
16S-54		⊖	●		▽	7		7				⊖°	16S-1	A=Al.; B=C; Balance=Cu				

NOTE: 16S contacts are used in shell sizes 8S, 10S, 10SL, 12S, 14S, & 16S. #Rotation commercial only. Not MS-approved. Not used for 97 series.

LAYOUTS BY SHELL SIZE

SERIES KEY: 97 (◆=97) AIT (◆=MS; ◆=non QPL) AIB (●=GT) VG95234 (■) MS3450 (▼=MS; ▼=non QPL) Thermocouple (⊖)
 CONTACT METALLURGY KEY: Alumel (Al.) Chromel (Ch.) Constantan (Con.) Copper (Cu) Iron (Ir.)

LAYOUT	97 Series	AIT Series	AIB/GT	VG95234	MS3450	TOTAL	CONTACTS SIZES						⊖	DEGREES OF ROTATION				SERVICE RATING
							20	16	12	8	4	0		W	X	Y	Z	
16S-55	◆	◆	●		▼	7		7					⊖	16S-1 A=Con.; Balance=Cu				
16A11				■		2			2					35	110	250	125	A
16SA18	◆	◆	●			7		7						16S-1	100°			A
16SA19	◆	◆	●			7		7						16S-1	260°			A
16SA20	◆	◆	●			7		7						16S-1	110°			A
16SA21	◆	◆	●			7		7						16S-1	250°			A
16-2		◆	●		▼	1			1					-	-	-	-	E
16-7	◆	◆	●	■	▼	3		2		1				80	110	250	280	A
16-9	◆	◆	●		▼	4		2	2					35	110	250	325	A
16-10	◆	◆	●	■	▼	3			3					90	180	270	-	A
16-11	◆	◆	●		▼	2			2					35	110	250	325	A
16-12	◆	◆	●	■	▼	1				1				-	-	-	-	A
16-13	◆	◆	●		▼	2			2				⊖	35	110	250	325	A = Ir.; B = Con.
16-52		◆	●		▼	2			2				⊖	16-11	90° A=Al.; B=Ch.			
16-53		◆	●		▼	4		2	2				⊖	16-9	70° A=Al.; C=Ch.; B, D=Cu			
16-55		◆	●		▼	3			3				⊖	16-10	45° A=Al.; B=Ch.; C=Cu			
16-56		◆	●		▼	2			2				⊖	16-13	90° A=Con.; B=Cu			
16-57		◆	●		▼	3			3				⊖	16-10	A=Al.; B=Cu; C=Ch.			
16-58		◆	●		▼	3			3				⊖	16-10	A=Con.; B, C=Cu			
16-59		◆	●			4			4					80	-	-	280	A
16-60		◆	●		▼	2			2				⊖	16-13	A=Al.; B=Ch.			
16-62		◆	●		▼	2			2				⊖	16-11	A=Con.; B=Cu			
18A31	◆	◆	●			10		10						18-1	110°			A (B,C,F,G) I (all others)
18-1	◆	◆	●	■	▼	10		10						70	145	215	290	A (B,C,F,G) I (all others)
18-3	◆	◆	●			2			2					35	110	250	325	D
18-4	◆	◆	●		▼	4		4						35	110	250	325	D
18-5	◆	◆	●		▼***	3		1	2					80	110	250	280	D
18-6		◆	●		▼***	1				1				-	-	-	-	D
18-7		◆^	●		▼	1				1				-	-	-	-	B
18-8	◆	◆	●		▼	8		7	1					70	-	-	290	A
18-9	◆	◆	●	■	▼	7		5	2					80	110	250	280	I
18-10	◆	◆	●		▼	4			4					-	120	240	-	A
18-11	◆	◆	●	■	▼	5			5					-	170	265	-	A
18-12	◆	◆	●		▼	6		6						80	-	-	280	A
18-13	◆	◆	●	■	▼	4			3	1				80	110	250	280	A
18-14		◆^			▼	2		1			1			80	110	250	280	A
18-15	◆†	◆	●		▼***	4			4				⊖	-	120	240	-	A, C=Ir. B, D=Con.
18-16	◆	◆^	●		▼	1			1					-	-	-	-	C
18-17	◆	◆	●		▼	7		5	2					18-9	100°			I
18-18	◆	◆	●		▼	7		5	2					18-9	250°			I
18-19	◆	◆	●		▼	10		10						80	120	240	-	A
18-20	◆	◆^	●			5		5						90	180	270	-	A
18-22	◆	◆^	●		▼	3		3						70	145	215	290	D
18-23	◆	◆	●		▼	10		10						18-1	100°			A(B,C,F,G) I (all others)
18-24	◆	◆	●		▼	10		10						18-1	250°			A(B,C,F,G) I (all others)
18-25	◆	◆	●			2			2					18-3	100°			D
18-26	◆	◆	●			2			2					18-3	250°			D

† Socket only for 97 Series ^ 5015 QPL not all configurations ***Socket only for MS3450 series ***Pin only for MS3450

NOTE: 16S contacts are used in shell sizes 8S, 10S, 10SL, 12S, 14S, & 16S

LAYOUTS BY SHELL SIZE

SERIES KEY: 97 (◆=97) AIT (◆=MS; ◆=non QPL) AIB (●=GT) VG95234 (■) MS3450 (▼=MS; ▼=non QPL) Thermocouple (⊞)
 CONTACT METALLURGY KEY: Alumel (Al.) Chromel (Ch.) Constantan (Con.) Copper (Cu) Iron (Ir.)

LAYOUT	97 Series	AIT Series	AIB/GT	VG95234	MS3450	TOTAL	CONTACTS SIZES						⊞	DEGREES OF ROTATION				SERVICE RATING
							20	16	12	8	4	0		W	X	Y	Z	
18-27	◆	◆	●		▼**	3		1	2					18-5	100°			D
18-28	◆	◆	●		▼**	3		1	2					18-5	250°			D
18-29	◆	◆^	●			5	5							90	180	270	-	A
18-30	◆	◆	●			5	5							18-20	110°			A
18-31	◆	◆	●			5	5							18-20	260°			A
18-420	◆					1 HV		1 HV						24 KVdc, 17 KVac				
18-51		◆	●	▼		6	6					⊞	18-12	A=Ir.; B, E=Con.; D=Cu; C, F=Dummy				
18-52		◆	●	▼		5		5				⊞	18-11	A=Ir.; B=Con.; C=Ch.; D=Al.; E=Dummy				
18-53		◆	●	▼		6	6					⊞	18-12	A, D=Ir.; B, E=Con.; C, F=Dummy				
18-54		◆	●	▼		4		4				⊞	18-15	A, C=Al.; B, D=Ch.				
18-56		◆	●	▼		10	10					⊞	18-1	45° A, C, E, G, I=Ir.; B, D, F, H, J=Con.				
18-57		◆	●	▼		6	6					⊞	18-12	45° A, C, E=Al.; B, D, F=Ch.				
18-59		◆	●	▼		6	6					⊞	18-12	45° A, C=Ir.; B, E, F=Con.; D=Cu				
18-60		◆	●	▼		5		5				⊞	18-11	45° A, D=Al.; B, C=Ch.; E=Cu				
18-61		◆	●	▼		6	6					⊞	18-12	A, C=Ir.; B, D=Con.; E=Ch.; F=Al.				
18-62		◆	●	▼		6	6					⊞	18-12	A, B, C=Ir.; D, E, F=Con.				
18-63		◆	●	▼		4		4				⊞	18-15	A, C=Con.; B, D=Cu				
18-65		◆	●	▼		6	6					⊞	18-12	A=Ir.; B=Con.; Balance=Cu				
18-66		◆	●	▼		10	10					⊞	18-1	A, C, E, G, I=Cu; B, D, F, H, J=Con.				
18-67		◆	●	▼		6	6					⊞	18-12	A, C, E=Cu; B, D, F=Con.				
18-68		◆	●	▼		5		5				⊞	18-11	A, D=Al.; B, C=Ch.; E=Cu				
18-69		◆	●	▼		10	10					⊞	18-1	A=Al.; B=Ch.; Balance=Cu				
18-70		◆	●	▼		5		5				⊞	18-11	A=Ir.; B=Con.; C=Ch.; D=Al.; E=Cu				
18-71		◆	●	▼		4		4				⊞	18-15	A=Con.; Balance=Cu				
18-72		◆	●	▼		4		4				⊞	18-15	D=Con.; Balance=Cu				
18-73		◆	●	▼		7	5	2				⊞	18-9	A=Al.; D=Ch.; Balance=Cu				
18-74		◆	●	▼		6	6					⊞	18-12	A=Ch.; B=Al.; D=Ir.; E=Cu; C, F=Con.				
20A9				■		9		9					-	110	250	-	-	D(J), I(all others)
20A16	◆	◆	●			13	13						20-11	182°				I
20A37	◆	◆	●			4		4					20-4	250°				D
20A48				■		19	19						80	280	-	-	-	I
20-2		◆	●	■	▼	1					1		-	-	-	-	-	D
20-3	◆	◆^	●			3		3					70	145	215	290		D
20-4	◆	◆	●	▼		4		4					45	110	250	-		D
20-6	◆	◆^	●			3	3						70	145	215	290		D
20-7	◆	◆	●	▼		8	8						80	110	250	280	A(B,C,F,G) I(all others)	
20-8	◆	◆	●	■	▼	6	4	2					80	110	250	280	I	
20-9		◆		▼		8	7	1					80	110	250	280	D(H), A(all others)	
20-11	◆	◆	●			13	13						-	-	-	-	I	
20-12		◆^				2	1			1			80	110	250	280	A	
20-14	◆	◆	●	▼		5		3	2				80	110	250	280	A	
20-15	◆	◆	●	▼		7		7					80	-	-	280	A	
20-16	◆	◆	●	▼		9	7	2					80	110	250	280	A	
20-17	◆	◆^	●	▼		6	1	5					90	180	270	-	A	
20-18	◆	◆	●	▼		9	6	3					35	110	250	325	A	
20-19	◆	◆	●	▼		3			3				90	180	270	-	A	
20-20		◆^	●			4		3		1			80	110	250	280	A	
20-21	◆	◆	●	▼		9	8	1					35	110	250	325	A	

** Socket only for MS3450 series ^ 5015 QPL not all configurations

NOTE: 16S contacts are used in shell sizes 8S, 10S, 10SL, 12S, 14S, & 16S

LAYOUTS BY SHELL SIZE

SERIES KEY: 97 (◆=97) AIT (⊕=MS; ⊖=non QPL) AIB (●=GT) VG95234 (■) MS3450 (▼=MS; ▽=non QPL) Thermocouple (⊖°)
 CONTACT METALLURGY KEY: Alumel (Al.) Chromel (Ch.) Constantan (Con.) Copper (Cu) Iron (Ir.)

LAYOUT	97 Series	AIT Series	AIB/GT	VG95234	MS3450	TOTAL	CONTACTS SIZES						⊖°	DEGREES OF ROTATION				SERVICE RATING
							20	16	12	8	4	0		W	X	Y	Z	
20-22		⊕	●		▼	6		3		3				80	110	250	280	A
20-23	◆	⊕	●			2				2				35	110	250	325	A
20-24	◆	⊕	●		▼	4		2		2				35	110	250	325	A
20-25	◆	⊖	●			13		13						20-11 100°				I
20-26		⊖	●			19		19						-	90	280	-	A
20-27	◆	⊕	●		▼	14		14						35	110	250	325	A
20-29	◆	⊕	●		▼	17		17						80	-	-	280	A
20-30	◆	⊖	●			13		13						20-11 250°				I
20-32	◆	⊖	●		▽	8		8						20-7 260°				A(B,C,F,G) I(all others)
20-33	◆	⊕	●		▼	11		11						-	-	-	280#	A
20-51		⊖	●			3				3				-	-	-	-	A
20-52		⊖	●		▽	4			4			⊖°	20-4 315° A=Ir.; B=Con.; C=Ch.; D=Al.					
20-56		⊖	●		▽	8		8				⊖°	20-7 45° A, B, G, H=Ir.; C, D, E, F=Con.					
20-57		⊖	●			7‡			7‡					-	-	-	-	A
20-58		⊖	●			10		5	5					-	-	-	-	A
20-59		⊖	●			3‡				3‡				-	-	-	-	A
20-60		⊖	●		▽	8		8				⊖°	20-7 45° D=Ch.; E=Al.; Balance=Cu					
20-61		⊖	●		▽	17		17				⊖°	20-29 45° A, B, M=Cu; Balance=Con.					
20-62		⊖	●		▽	7			7			⊖°	20-15 80° A, C, E=Al.; B, D, F=Ch.; G=Cu					
20-64		⊖	●		▽	14		14				⊖°	20-27 A=Al.; C=Ch.; Balance=Cu					
20-65		⊖	●		▽	14		14				⊖°	20-27 A, B, C, D, E, F, G=Ir.; H, I, J, K, L, M, N=Con.					
20-66		⊖	●			6‡		1	5‡					-	-	-	-	A
20-67		⊖	●		▽	9		7	2			⊖°	20-16 H=Al.; I=Ch.; Balance=Cu					
20-68		⊖	●		▽	8		8				⊖°	20-7 A, B, G, H=Con.; C, D, E, F=Cu					
20-69		⊖	●		▽	14		14				⊖°	20-27 A, B, C, D, E, F, G=Cu; H, I, J, K, L, M, N=Con.					
20-70		⊖	●		▽	17		17				⊖°	20-29 A, C, E, G, J, L, N, R, T=Ir.; B, D, F, H, K, M, P, S=Con.					
20-71		⊖	●		▽	17		17				⊖°	20-29 S=Al.; R=Ch.; Balance=Cu					
20-74		⊖	●		▽	17		17				⊖°	20-29 A, C, E, G, J, L, N, R=Ir.; B, D, F, H, K, M, P, S=Con.; T=Cu					
20-75		⊖	●		▽	7			7			⊖°	20-15 G=Al.; Balance=Ch.					
20-77		⊖	●		▽	9		7	2			⊖°	20-16 A=Con.; Balance=Cu					
20-79		⊖	●			8‡		7	1‡					-	-	-	-	D(H); A (all others)
20-80		⊖	●		▽	14		14				⊖°	20-27 A, C, E, G, I, K, M=Cu; B, D, F, H, J, L, N=Con.					
20-81		⊖	●		▽	14		14				⊖°	20-27 A, C, E, G, I, K, M=Ch.; B, D, F, H, J, L, N=Al.					
20-82		⊖	●		▽	17		17				⊖°	20-29 A, C, E, G, J, L, N, R=Al.; B, D, F, H, K, M, P, S=Ch.; T=Cu					
22B22				■		4				4				-	110	250	-	A
22-1	◆	⊕	●			2				2				35	110	250	325	D
22-2	◆	⊕	●	■	▼	3				3				70	145	215	290	D
22-4	◆	⊕	●		▼***	4			2	2				35	110	250	325	A
22-5	◆	⊕	●		▼***	6		4	2					35	110	250	325	D
22-6		⊕	●		▼***	3		1		2				80	110	250	280	D
22-7		⊕	●		▼***	1					1			-	-	-	-	E
22-8	◆	⊕^	●			2			2					35	110	250	325	E
22-9	◆	⊕	●		▽	3			3					70	145	215	290	E
22-10	◆	⊕	●		▽	4		4						35	110	250	325	E
22-11	◆	⊕	●		▽	2		2						35	110	250	325	B
22-12	◆	⊕^	●	■		5		3		2				80	110	250	280	D
22-13	◆	⊕^	●			5		1	4					35	110	250	325	A(A-D) D(E)

#Rotation commercial only, not MS-approved ‡ Reduced contact crimp pot ^ 5015 QPL not all configurations
 ** Socket only for MS3450 series ***Pin only for MS3450 series

LAYOUTS BY SHELL SIZE

SERIES KEY: 97 (◆=97) AIT (⊕=MS; ⋄=non QPL) AIB (●=GT) VG95234 (■) MS3450 (▼=MS; ▽=non QPL) Thermocouple (⊖) CONTACT METALLURGY KEY: Alumel (Al.) Chromel (Ch.) Constantan (Con.) Copper (Cu) Iron (Ir.)

LAYOUT	CONTACTS SIZES					TOTAL	°	DEGREES OF ROTATION				SERVICE RATING	
	20	16	12	8	4			0	W	X	Y		Z
22-14	◆	⊕	●	■	▼	19		80	110	250	280	A	
22-15	◆	⊕	●		▽	6		80	110	250	280	A(A-C, E, F) E(D)	
22-16	◆	⊕	●			9		80	110	250	280	A	
22-17		⊕^	●		▽	9		80	110	250	280	D(A) A(all others)	
22-18	◆	⊕	●		▽	8		80	110	250	280	A(C-E) D(all others)	
22-19	◆	⊕	●	▼		14		80	110	250	280	A	
22-20	◆	⊕^	●			9		35	110	250	325	A	
22-21		⊕^	●	▼		3		80	110	250	280	A	
22-22	◆	⊕	●	■	▼	4		-	110	250	-	A	
22-23	◆	⊕	●		▼	8		35	-	250	-	D(A-D); A(E-G)	
22-24		⊕	●			6		80	110	250	280	D(C, D, E) A(A, B, F)	
22-26	◆					7		-	-	-	-	1/8" spacing	
22-27	◆	⊕	●	■	▽	9		80	-	250	280	D(J) A(all others)	
22-28	◆	⊕^	●			7		80	-	-	280	A	
22-30	◆	⋄	●		▽	19		22-14	100°			A	
22-31	◆	⋄	●			2		22-11	100°			B	
22-32	◆	⋄	●		▽	6		22-5	260°			D	
22-33		⊕^	●			7		80	110	250	280	D(A-D) A(E-G)	
22-34	◆	⊕				5		80	110	250	280	D	
22-36					▽	8		90	-	270	-	D(H); A(all others)	
22-57		⋄	●		▽	19		⊖	22-14	45°	A, C, E, G, J, L, N, R=Ir.; B, D, F, H, K, M, P, S=Con.; T, U, V=Cu		
22-60		⋄	●		▽	19		⊖	22-14	45°	U=Al.; N=Ch.; Balance=Cu		
22-62		⋄	●		▽	8		⊖	22-23	60°	A, B, F, G=Al.; C, D, E, H=Ch.		
22-63		⋄	●			12			20	-	-	A	
22-65		⋄	●			8‡			-	-	-	D(H); A(all others)	
22-68		⋄	●		▽	14		⊖	22-19	45°	A, C, E, G, J, L, M=Ir.; B, D, F, H, K, P, N=Con.		
22-69		⋄	●		▽	14		⊖	22-19	45°	A, C, E, G, J, L, M=Cu; B, D, F, H, K, P, N=Con.		
22-70		⋄	●		▽	13			-	-	-	A	
22-71		⋄	●		▽	19		⊖	22-14	V=Al.; U=Ch.; Balance=Cu			
22-72		⋄	●		▽	6		⊖	22-5	B=Al.; E=Ch.; Balance=Cu			
22-73		⋄	●		▽	6		⊖	22-5	E=Al.; B=Ch.; Balance=Cu			
22-74		⋄	●		▽	8		⊖	22-23	A, C, E, G=Ir.; B, D, F, H=Con.			
22-75		⋄	●		▽	8		⊖	22-23	A=Al.; B, D, G, H=Cu; C=Ch.; E=Ir.; F=Con.			
22-76		⋄	●			21		⊖		W=Con.; Balance=Cu			
22-77		⋄	●		▽	14		⊖	22-19	B, D, F, H, J, K, M, P=Cu; A, E, L=Ir.; C, G, N=Con.			
22-78		⋄	●		▽	19		⊖	22-14	A, C, E, G, H, K, M, P, R, T=Con.; Balance=Cu			
22-79		⋄	●		▽	4		⊖	22-10	A, C=Con.; B, D=Cu			
22-80		⋄	●			3‡			-	-	-	A	
24A35		⋄	●			16			24-7	100°		A	
24-2	◆	⊕	●	▼		7			80	-	-	280	D
24-3		⊕^	●			7			80	110	250	280	D
24-4					▽	4			80	110	250	280	D
24-5	◆	⊕	●	▼		16			80	110	250	280	A
24-6	◆	⊕^	●		▽	8			80	110	250	280	D(A,G,H) A(all others)
24-7	◆	⊕	●	▼		16			80	110	250	280	A

^ 5015 QPL not all configurations

LAYOUTS BY SHELL SIZE

SERIES KEY: 97 (◆=97) AIT (⊕=MS; ⊖=non QPL) AIB (●=GT) VG95234 (■) MS3450 (▼=MS; ▽=non QPL) Thermocouple (⊖°)

CONTACT METALLURGY KEY: Alumel (Al.) Chromel (Ch.) Constantan (Con.) Copper (Cu) Iron (Ir.)

LAYOUT	CONTACTS SIZES					TOTAL	DEGREES OF ROTATION				SERVICE RATING						
	97 Series	AIT Series	AIB/GT	VG95234	MS3450		20	16	12	8		4	0	⊖°	W	X	Y
24-9	◆	⊕	●	■		2				2			35	110	250	325	A
24-10	◆	⊕	●	■	▼	7			7				80	-	-	280	A
24-11	◆	⊕	●	■	▼	9		6	3				35	110	250	325	A
24-12	◆	⊕	●	■	▼	5		3		2			80	110	250	280	A
24-15		⊖	●		▽	16	16						24-5 100°				A
24-16	◆	⊕^	●		▽	7	3	3	1				80	110	250	280	D(A, B, F, G) A(C, D, E)
24-17		⊕^	●			5	3	2					80	110	250	280	D
24-19	◆	⊖	●			12	12						-	-	-	-	A
24-20	◆	⊕	●	▼		11	9	2					80	110	250	280	D
24-21	◆	⊕	●	▽		10	9		1				80	110	250	280	D
24-22	◆	⊕	●	▼		4			4				45	110	250	-	D
24-24				▽		16	16						24-5 250°				A
24-25	◆	⊖	●			8		8					24-6 100°				D(A, G, H) A(all others)
24-26	◆	⊖	●			8		8					24-6 250°				D(A, G, H) A(all others)
24-27	◆	⊕	●	▽		7	7						80	-	-	280	E
24-28	◆	⊕	●	■	▼	24	24						80	110	250	280	I
24-51		⊖	●			5			5				-	108	-	-	A
24-52		⊖	●			1 HV		1 HV					30 KVdc, 21 KVac				
24-53		⊖	●			5‡			5‡				-	108	-	-	A
24-56		⊖	●	▽		11	9	2				⊖°	24-20 45° E=Al.; F=Ch.; Balance=Cu				
24-57		⊖	●	▽		24	24					⊖°	24-28 45° A, C, J, V, Y, W, K, E, H, U, S, M=Ch.; Balance=Al.				
24-58		⊖	●			13	7	3	3				-	-	-	-	A
24-59		⊖	●			14	7	7					-	-	-	-	A
24-60		⊖	●			7‡			7‡				-	-	-	-	A
24-62		⊖	●	▽		24	24					⊖°	24-28 A, C, E, G=Ir.; B, D, F, H=Con.; R, T=Ch.; S, U=Al.; Balance=Cu				
24-63		⊖	●	▽		24	24					⊖°	24-28 A, C, E, G, J, L, K, N, S, U, W, Y=Cu; B, D, F, H, Q, R, M, P, T, V, X, Z=Con.				
24-64		⊖	●	▽		16	16					⊖°	24-5 A, B, C, D, E, F, G, H=Ir.; J, K, L, M, N, P, R, S=Con.				
24-65		⊖	●			15	4	11					-	-	-	-	A
24-66		⊖	●			7		7					-	-	-	-	D
24-67		⊖	●			19		19					16	-	-	-	I
24-68		⊖	●	▽		24	24					⊖°	24-28 D=Con.; Balance=Cu				
24-71		⊖	●			7‡			7‡				-	-	-	-	A
24-75		⊖	●			7‡			7‡				-	-	-	-	A
24-79		⊖	●			5			5				-	108	-	-	A
24-80		⊖	●	▽		23	23						35	145	240	300	I
24-81		⊖	●			16	14	2				⊖°	24-7 A, C, E, G, I, K, M, N, P=Cu; B, D, F, H, J, L, O=Con.				
24-84		⊖	●			19		19(18)					-	-	-	-	A/Coax
24-96		⊖	●			28	28						65	-	-	-	I
24-AJ		⊖	●			25	25						80	110	250	280	A
28A63			■			28	19	9					-	110	260	-	A
28-1	◆	⊕	●	▼		9		6	3				80	110	250	280	D(A, E, J) A(all others)
28-2	◆	⊕	●	▼		14	12	2					35	110	250	325	D
28-3	◆	⊕	●	▽		3			3				70	145	215	290	E
28-4		⊕^	●	▽		9	7	2					80	110	250	280	E(G, P, S) D(all others)
28-5		⊕^	●	▽		5	2	1		2			35	110	250	325	D
28-6	◆	⊕^	●			3				3			70	145	215	290	D
28-7		⊖	●			2				2			35	110	250	325	D

‡ Reduced contact crimp pot ^ 5015 QPL not all configurations () Number of contacts that are coax

LAYOUTS BY SHELL SIZE

SERIES KEY: 97 (◆=97) AIT (⊕=MS; ⊖=non QPL) AIB (●=GT) VG95234 (■) MS3450 (▼=MS; ▽=non QPL) Thermocouple (⊖) CONTACT METALLURGY KEY: Alumel (Al.) Chromel (Ch.) Constantan (Con.) Copper (Cu) Iron (Ir.)

LAYOUT	97 Series	AIT Series	AIB/GT	VG95234	MS3450	TOTAL	CONTACTS SIZES						°	DEGREES OF ROTATION				SERVICE RATING
							20	16	12	8	4	0		W	X	Y	Z	
28-8	◆	⊕^	●		▽	12		10	2					80	110	250	280	E(L, M) D(B) A(all others)
28-9	◆	⊕	●		▼	12		6	6					80	110	250	280	D
28-10	◆	⊕	●		▼	7			3	2	2			80	110	250	280	D(G) A(all others)
28-11	◆	⊕	●	■	▼	22		18	4					80	110	250	280	A
28-12	◆	⊕	●		▼	26		26						90	180	270	-	A
28-13	◆	⊖	●		▽	26		26					28-12	100°				A
28-15	◆	⊕	●		▼	35		35						80	110	250	280	A
28-16	◆	⊕	●		▽	20		20						80	110	250	280	A
28-17	◆	⊕	●		▼	15		15						80	110	250	280	A(A-L) B(R) D(M-P)
28-18	◆	⊕	●		▽	12		12						70	145	215	290	C(M) D(G, H, J, K, L) A(A, B) I(C, D, E, F)
28-19	◆	⊕	●		▽	10		6	4					80	110	250	280	A(C, E, G, J, K, L) B(H, M) D(A, B)
28-20	◆	⊕^	●	■	▼	14		4	10					80	110	250	280	A
28-21	◆	⊕	●	■	▼	37		37						80	110	250	280	A
28-22		⊕^	●	■	▼	6		3			3			70	145	215	290	D
28-51		⊖	●			12			12					80	135	195	-	A
28-53		⊖	●		▽	22		18	4				⊖	28-11	45°	J, L=Al.; K, M=Ch.; Balance=Cu		
28-58		⊖	●		▽	14		4	10				⊖	28-20	45°	A, C, E, G, K, M=Al.; B, D, F, H, L, N=Ch.; J, P=Cu		
28-59		⊖	●			17		10	7					-	-	-	-	A
28-61		⊖	●		▽	37		37					⊖	28-21	45°	A, C, J, Z, m, r, n, a, K, F, H, X, k, h, T, M, N, d=Ir.; Balance=Con.		
28-63		⊖	●		▽	14		4	10				⊖	28-20	45°	A, C, E, G, J=Al.; B, D, F, H, P=Ch.; Balance=Cu		
28-64		⊖	●		▽	35		35					⊖	28-15	A, d=Al.; B, j=Ch.; C, D, E, F, G, N, P, R, S, H, J, K, L, M, W, X, Y, Z=Con.; Balance=Cu			
28-65		⊖	●		▽	26		26					⊖	28-12	A, C, E, G, J, L, N, R, T, V=Ir.; X, Z=Al.; B, D, F, H, K, M, P, S, U, W=Con.; Y, a=Ch.; b, d=Cu			
28-66		⊖	●			16			14	2				50	100	165	-	A
28-67		⊖	●		▽	20		20					⊖	28-16	U=Con.; Balance=Cu			
28-68		⊖	●		▽	35		35					⊖	28-15	45°	T=Al.; U=Ch.; Balance=Cu		
28-69		⊖	●		▽	22		18	4				⊖	28-11	G=Al.; R=Ch.; Balance=Cu			
28-70		⊖	●		▽	22		18	4				⊖	28-11	A=Al.; B=Ch.; Balance=Cu			
28-72		⊖	●			3					3(3)			-	-	-	-	Coax
28-74		⊖	●			16‡		9			7‡			70	133	227	290	A
28-75		⊖	●			16‡		9			7‡			70	133	227	290	A
28-79		⊖	●			16		9			7			70	133	227	290	A
28-82		⊖	●			6			4	2				-	-	-	-	D
28-84		⊖	●			9				9				45	157	90	135	A
28-77		⊖	●		▽	22		18	4				⊖	28-11	J=Con.; Balance=Cu			
28-81		⊖	●		▽	37		37					⊖	28-21	A, D, S, Z, n, s=Ir.; B, J, K, f, g, r=Con.; G, L, P, b, e, j=Al.; F, H, T, X, h, k=Ch.; Balance=Cu			
28-AY		⊖	●			9		5			4			80	110	250	280	A
32A29		⊖	●			23		16	2	3	2			32-6	250°			A
32A30		⊖	●			5			3			2		32-1	100°			E(A) D(all others)
32A69				■		61	41	20						-	110	250	-	I
32-1		⊕		■	▼	5			3			2		80	110	250	280	E(A) D(all others)
32-2		⊕	●		▽	5		2			3			70	145	215	290	E

‡ Reduced contact crimp pot ^ 5015 QPL not all configurations () Number of contacts that are coax

LAYOUTS BY SHELL SIZE

SERIES KEY: 97 (◆=97) AIT (⊕=MS; ⊕=non QPL) AIB (●=GT) VG95234 (■) MS3450 (▼=MS; ▽=non QPL) Thermocouple (⊖)

CONTACT METALLURGY KEY: Alumel (Al.) Chromel (Ch.) Constantan (Con.) Copper (Cu) Iron (Ir.)

LAYOUT	97 Series	AIT Series	AIB/GT	VG95234	MS3450	TOTAL	CONTACTS SIZES					⊖	DEGREES OF ROTATION				SERVICE RATING	
							20	16	12	8	4		0	W	X	Y		Z
32-3		⊕	●	■	▽	9		4	2		2	1		80	110	250	280	D
32-4		⊕^	●			14		12	2					80	110	250	280	A(F, J, K, N) D(all others)
32-5	◆	⊕	●			2						2		35	110	250	325	D
32-6	◆	⊕	●	■	▼	23		16	2	3	2			80	110	250	280	A
32-7	◆	⊕	●	■	▼	35		28	7					80	125	235	280	I(A, B, H, J) A(all others)
32-8	◆	⊕	●			30		24	6					80	125	235	280	A
32-9		⊕^	●		▼	14		12			2			80	110	250	280	D
32-10		⊕^	●			7		3		2	2			80	110	250	280	E(A, F) B(G) D(E) A(D)
32-12		⊕^	●			15		10	5					80	110	250	280	A(C, D, E, F, G) D(all others)
32-13	◆	⊕	●		▼	23		18	5					80	110	250	280	D
32-14		⊕				13			13					65	130	230	295	D
32-15		⊕^	●		▼	8			6			2		35	110	250	280	D
32-16		⊕	●		▽	23		16	2	3	2			32-6	100°			A
32-17	◆	⊕	●		▼	4					4			45	110	250	-	D
32-19		⊕	●		▽	5			3			2		32-1	260°			E(A) D(all others)
32-20		⊕	●		▽	23		16	2	3	2			32-6	260°			A
32-22		⊕	●		▽	54		54						80	110	250	280	A
32-25		⊕	●			25			25					60	125	-	-	A
32-31		⊕	●			31		31						80	125	215	280	A
32-48		⊕	●			48		48						80	-	-	-	I
32-51		⊕	●			30		24	6				⊖	32-8	90°M=Ch.; N=Al.; Balance=Cu			
32-52		⊕	●			8			6			2		32-15	90°			D
32-53		⊕	●			42		37	5					-	-	-	-	IE
32-55		⊕	●			30		24	6				⊖	32-8	125°M, N=Ch.; O, P=Al.; Balance=Cu			
32-56		⊕	●			30‡		24	6‡					-	-	-	-	A
32-57		⊕	●			8			6			2(2)		-	-	-	-	Coax
32-58		⊕	●			.4					4(4)			-	-	-	-	Coax
32-59		⊕	●			42		40		2(2)				-	-	-	-	Coax
32-60		⊕	●			23			15	8(8)				72	145	215	200	A/Coax
32-62		⊕	●			23		16	2	3(2)	2			-	-	-	-	A/Coax
32-63					▼	5					5			-	-	-	-	D
32-64		⊕	●			54		54						80	100	110	250	I
32-68		⊕	●			16		12			4(4)			30	-	-	-	A/Coax
32-73		⊕	●		▼	46		46						36	-	-	-	A
32-75		⊕	●			9			2	7(7)				-	-	-	-	Coax
32-76		⊕	●			19			19					44	147	254	-	A
32-79		⊕	●			5				1	4			-	-	-	-	D
32-82		⊕	●			16		12			4			30	-	-	-	A
32-414	◆					52		52						-	-	-	-	A
32-AF		⊕	●			55		55						80	110	250	280	A
36-1	◆	⊕^	●			22		18	4					80	110	250	280	D
36-3		⊕^	●	■	▼	6			3			3		70	145	215	290	D
36-4		⊕^	●			3						3		70	145	215	290	A(B, C) D(A)
36-5	◆	⊕	●	■	▼	4						4		-	120	240	-	A
36-6	◆	⊕	●	■	▼	6					4	2		35	110	250	325	A
36-7	◆	⊕	●		▼	47		40	7					80	110	250	280	A
36-8	◆	⊕	●		▼	47		46	1					80	110	250	280	A

‡ Reduced contact crimp pot ^ 5015 QPL not all configurations () Number of contacts that are coax

LAYOUTS BY SHELL SIZE

SERIES KEY: 97 (◆=97) AIT (⊕=MS; ◆=non QPL) AIB (●=GT) VG95234 (■) MS3450 (▼=MS; ▽=non QPL) Thermocouple (⊖)

CONTACT METALLURGY KEY: Alumel (Al.) Chromel (Ch.) Constantan (Con.) Copper (Cu) Iron (Ir.)

LAYOUT	97 Series	AIT Series	AIB/GT	VG95234	MS3450	TOTAL	CONTACTS SIZES						⊖	DEGREES OF ROTATION				SERVICE RATING
							20	16	12	8	4	0		W	X	Y	Z	
36-9	◆	⊕	●		▼	31		14	14	2	1			80	125	235	280	A
36-10	◆	⊕	●	■	▼	48		48						80	125	235	280	A
36-11	◆	◆	●		▽	48		48						36-10	100°			A
36-12	◆	◆	●		▽	48		48						36-10	250°			A
36-13		⊕^	●			17		15	2					80	110	250	280	E(N,P,Q) A(all others)
36-14		⊕^	●			16		6	5	5				90	180	270	-	D
36-15	◆	⊕	●		▼	35		35						60	125	245	305	D(M) A(all others)
36-16		◆	●		▽	47		40	7					36-7	100°			A
36-17		◆	●		▽	47		40	7					36-7	250°			A
36-18		◆	●		▽	31		14	14	2	1			36-9	100°			A
36-20		◆	●			34		30	2	2				-	-	-	-	A
36-21		◆	●		▽	31		14	14	2	1			36-9	260°			A
36-22		◆	●			22			22					-	-	-	-	D
36-51		◆	●			4					2	2		-	127	-	-	D
36-52		⊕^	●		▼	52		52						72	144	216	288	A
36-53		◆	●		▽	47		40	7				⊖	36-7	45° u, v, w=Al.; x, y, z=Ch.; Balance=Cu			
36-54		◆	●			39		31		8				-	-	-	-	A
36-55		◆	●			39‡		31		8‡				-	-	-	-	A
36-56		◆	●		▽	48		48					⊖	36-10 A, C, E, G, L, J, H, P, R, T, V, X, Z, b, d, f, h, k, q, n, m, u, w, y=Con.; Balance=Cu				
36-59		◆	●			53‡		50	3‡					-	-	-	-	A
36-60		◆	●			47‡		40	7‡					-	-	-	-	A
36-61		◆	●		▽	35		35					⊖	36-15 A, C, E, J, K, L, M, N, P, R, T, V, f, X, Y, h, j, c=Con.; Balance=Cu				
36-62		◆	●		▽	48		48					⊖	36-10 A, C, E=Al.; B, D, F=Ch.; Balance=Cu				
36-64		◆	●			4						4(4)		-	-	-	-	Coax
36-65		◆	●			4						4(4)		-	-	-	-	Coax
36-66					▽	56		52	4					110	250	260	280	A
36-71		◆	●			53		50	3					-	-	-	-	A
36-73		◆	●			7					7(7)			81	279	-	-	Coax
36-74		◆	●			44		43	1(1)					-	-	-	-	A
36-75		◆	●			48‡		48‡						-	-	-	-	A
36-76		◆	●			47		47						-	-	-	-	A
36-77		◆	●			7					7			81	279	-	-	D
36-78		◆	●			14		2		12				35	106	254	325	A
36-79		◆	●			20			20					30	110	250	330	A
36-80		◆	●			20‡			20‡					30	110	250	330	A
36-82		◆	●		▽	52		52					⊖	36-52 v, g=Ir.; p, y, c=Con. x=Ch.; Balance=Cu				
36-83		◆	●			7					7(7)			81	279	-	-	Coax
36-85		◆	●			35‡		35‡						-	-	-	-	A/D
36-403	◆					52		52						-	-	-	-	A
36-57		◆	●		▽	47		46	1				⊖	36-8 W=Al.; f=Ch.; Balance=Cu				
36-58		◆	●		▽	35		35					⊖	36-15 H=Al.; G=Ch.; Balance=Cu				
36-AF		◆	●			48		48						65	-	-	-	A
40-1		⊕	●		▼	30		24	6					65	130	235	300	D
40-2					▽	23		23						80	110	250	280	D
40-3					▽	23		18	4		1			80	110	250	280	D

‡ Reduced contact crimp pot ^ 5015 QPL not all configurations () Number of contacts that are coax

LAYOUTS BY SHELL SIZE





SERIES KEY: 97 (◆=97) AIT (⊕=MS; ◆=non QPL) AIB (●=GT) VG95234 (■) MS3450 (▼=MS; ▽=non QPL) Thermocouple (⊖)

CONTACT METALLURGY KEY: Alumel (Al.) Chromel (Ch.) Constantan (Con.) Copper (Cu) Iron (Ir.)

LAYOUT	97 Series	AIT Series	AIB/GT	VG95234	MS3450	TOTAL	CONTACTS SIZES						⊖	DEGREES OF ROTATION				SERVICE RATING
							20	16	12	8	4	0		W	X	Y	Z	
40-4				▽		23		16	2	3	2			80	110	250	280	D
40-5##				▽		15			6	4	2	3		80	110	250	280	A
40-5	◆	●				5						5		33	-	-	270	A
40-6				▽		26		24	1			1		80	110	250	280	D
40-7				▽		22		18	2			2		80	110	250	280	P,Q,U,V,W,X=A; Bal=D
40-9	⊕	●		▼		47		24	22	1				65	125	225	310	A
40-10	⊕^	●				29		16		9	4			65	125	225	310	A
40-35	◆	●				35			35					70	130	230	290	D
40-53	◆	●				60		60						80	110	250	280	A
40-56	⊕	●		▼		85		85						72	144	216	288	A
40-57	◆	●				4						4		30	150	-	-	E
40-58	◆	●		▽		85		85					⊖	40-56 A, C, E, H, K, M, P, S, U, W, Y, a, c, f, h, j, m, p, r, t, v, x, z, AB, AD, AF, AJ, AL, AN, AP, AS, AU, AW, AY, BA, BC, BE, BH, BK, BM, BP, BS, BU=Ir.; Balance=Con.				
40-59	◆	●		▽		85		85					⊖	40-56 B=Ch.; C=Con.; Balance=Cu				
40-61	◆	●				59		55	3	1				-	-	-	-	A
40-62	⊕	●		▽		60		60						30	130	220	290	A
40-63	◆	●				61‡		61‡						-	-	-	-	A
40-64	◆	●				36		20	3	13(13)				-	-	-	-	Coax
40-66	◆	●				4						4(4)		-	-	-	-	Coax
40-67	◆	●				11		1				10(10)		-	-	-	-	A/Coax
40-68	◆	●				21			21					-	-	-	-	A
40-70	◆	●				61		61						-	-	-	-	A
40-72	◆	●				11		1				10(10)		-	-	-	-	A/Coax
40-73	◆	●				61		61						-	-	-	-	A
40-74	◆	●				6			1		1(1)	4(4)		-	-	-	-	A/Coax
40-75	◆	●				5			1			4		-	-	-	-	E
40-77	◆	●				60		60					⊖	40-56 55, 60=Ir.; 57, 58, 59=Con.; 56=Ch.; Balance=Cu				
40-78	◆	●				60			60				⊖	40-53 50 51=Ir.; 27, 28, 29, 31, 32, 34, 36, 37=Con.; 25, 39, 40, 41=Al 43,44,45, 46, 47, 48, 49, 52, 53, 54=Ch.; Balance=Cu				
40-80	◆	●				11		1				10		72	144	210	288	A
40-81	◆	●				62‡		62‡						-	-	-	-	A
40-82	◆	●				62		62						-	-	-	-	A
40-85	◆	●				60‡		60‡						-	-	-	-	A
40-86	◆	●				4						4(4)		-	-	-	-	E/Coax
40-87	◆	●				7					7			37	74	285	322	D
40-AD	◆	●				8			4			4		45	-	-	-	A
40-AG	◆	●				38			38					37	74	285	322	A
40-AT	◆	●				43		18	24	1				80	110	250	280	A
40-AV	◆	●				3						3#2/0		90	180	270	-	D

‡ Reduced contact crimp pot ^ 5015 QPL not all configurations () Number of contacts that are coax

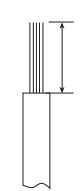
PIN & SOCKET CRIMP CONTACTS

		PIN CONTACT		SOCKET CONTACT		WIRE STRIP LENGTHS	WIRE RANGE	
								
CONTACT SIZE	WIRE SIZE	PART NUMBER				WIRE STRIP LENGTHS INCHES (MM)	WIRE SEALING RANGE INCHES (MM)	
		PIN CONTACT		SOCKET CONTACT				
		SILVER	GOLD	SILVER	GOLD			
16S†	16-18-20	AIC16S-16P	AIC16S-16PG	AIC16S-16S	AIC16S-16SG	-	.312 (7.9)	.090 - .118 (2.3-3.0)
	12-14	AIC16S-12P	AIC16S-12PG	AIC16S-12S	AIC16S-12SG	C4		
	14-16	AIC16S-14P	AIC16S-14PG	AIC16S-14S	AIC16S-14SG	C3		
	18-20	AIC16S-20P	AIC16S-20PG	AIC16S-20S	AIC16S-20SG	C13		
	20-22	AIC16S-22P	AIC16S-22PG	AIC16S-22S	AIC16S-22SG	C14		
	22-24	AIC16S-24P	AIC16S-24PG	AIC16S-24S	AIC16S-24SG	C2		
16	16-18-20	AIC16-16P	AIC16-16PG	AIC16-16S	AIC16-16SG	-		
	12-14	AIC16-12P	AIC16-12PG	AIC16-12S	AIC16-12SG	C4		
	14-16	AIC16-14P	AIC16-14PG	AIC16-14S	AIC16-14SG	C3		
	18-20	AIC16-18P	AIC16-18PG	AIC16-18S	AIC16-18SG	C13		
	20-22	AIC16-20P	AIC16-20PG	AIC16-20S	AIC16-20SG	C14		
	20-24	AIC16-2024P	AIC16-2024PG	AIC16-2024S	AIC16-2024SG	C36		
12	22-24	AIC16-22P	AIC16-22PG	AIC16-22S	AIC16-22SG	C2		
	12-14	AIC12-12P	AIC12-12PG	AIC12-12S	AIC12-12SG	-		
	12 High-Power	-	-	AIC12-12SRAD	-	-		
	8-10	AIC12-8P	AIC12-8PG	AIC12-8S	AIC12-8SG	C5		
	10-12	AIC12-10P	AIC12-10PG	AIC12-10S	AIC12-10SG	C8		
	14-16	AIC12-14P	AIC12-14PG	AIC12-14S	AIC12-14SG	C9		
	16-18	AIC12-16P	AIC12-16PG	AIC12-16S	AIC12-16SG	C7		
8	18-20	AIC12-18P	AIC12-18PG	AIC12-18S	AIC12-18SG	C6		
	20-22	AIC12-20P	AIC12-20PG	AIC12-20S	AIC12-20SG	C40		
	8	AIC8-8P	AIC8-8PG	AIC8-8S	AIC8-8SG	-		
	8 High-Power	-	-	AIC8-8SRAD	-	-		
4	10-12	AIC8-10P	AIC8-10PG	AIC8-10S	AIC8-10SG	C10		
	12-14	AIC8-12P	AIC8-12PG	AIC8-12S	AIC8-12SG	C38		
	4	AIC4-4P	AIC4-4PG	AIC4-4S	AIC4-4SG	-		
	4 High-Power	-	-	AIC4-4SRAD	-	-		
0	8	AIC4-8P	AIC4-8PG	AIC4-8S	AIC4-8SG	C15		
	0	AIC0-0P	AIC0-0PG	AIC0-0S	AIC0-0SG	-		
	0 High-Power	-	-	AIC0-0SRAD	-	-		
	0-2	AIC0-2P	AIC0-2PG	AIC0-2S	AIC0-2SG	C11		
	4	AIC0-4P	AIC0-4PG	AIC0-4S	AIC0-4SG	C12		

Bolded items are standard crimp contacts.







SOLDER THERMOCOUPLE CONTACTS			
	TYPE	PINS	SOCKETS
16S†	Alumel	10-040799-02P*	10-040799-02S*
	Chromel	10-040799-01P*	10-040799-01S*
	Iron	10-040799-03P*	10-040799-03S*
	Constantan	10-040799-04P*	10-040799-04S*
16	Alumel	10-040799-12P*	10-040799-12S*
	Chromel	10-040799-11P*	10-040799-11S*
	Iron	10-040799-13P*	10-040799-13S*
	Constantan	10-040799-14P*	10-040799-14S*

SOLDER THERMOCOUPLE CONTACTS			
	TYPE	PINS	SOCKETS
12	Alumel	10-040799-42P*	10-040799-42S*
	Chromel	10-040799-41P*	10-040799-41S*
	Iron	10-040799-43P*	10-040799-43S*
	Constantan	10-040799-44P*	10-040799-44S*

Thermocouple Types: **J** = Iron-Constantan **K** = Alumel-Chromel
T = Copper-Constantan **E** = Chromel-Constantan

*Contact us for availability

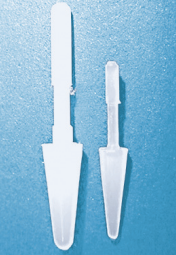
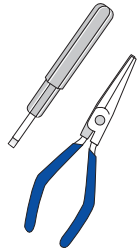



† 16S contacts are used in 8S, 10S, 10SL, 12S, 14S and 16S connector sizes only.

ACCESSORIES		TOOLS						
								
CONTACT SIZE	WIRE HOLE FILLER COLOR	CRIMP TOOLS	CRIMP LOCATOR & DIE SETS	LOCATOR COLOR	PILOT PIN/INSERTION GUIDE FOR SOCKETS	INSERTION TOOL	EXTRACTION TOOL	
16S†	MS27488-16-3 (Blue)	AF8-(hand) WA27F-(pneumatic) ††	TH29-1	Red	10-242758-016	DAK168-16	DRK59 Kit with Multiple Tips	
16				Pin-Blue Socket- Green				
12				Green				
8	MS27488-8-3 (Red)	400BHD	Die Set 414DA-8N Locator 4025-Pin 4026-Socket	-	10-242758-008	DAK282		
4	MS27488-4-3 (Blue)		Die Set 414DA-4N Locator 4043-2	-	-	AIC4INS		AIC4EXT
0	MS27488-0-3 (Yellow)		Die Set 414DA-0N Locator 4042	-	-	AIC0INS		AIC0EXT

†† Contact us for additional tool accessories.

PIN & SOCKET COAX CONTACTS

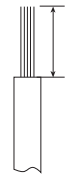
5015 - AMPHENOL AIB/GT SERIES MIL-DTL-5015

		PIN CONTACT		SOCKET CONTACT		WIRE STRIP LENGTH	WIRE RANGE	ACCESSORIES	
									
COAX CONTACT SIZE	COAX WIRE SIZE	PART NUMBER				WIRE STRIP LENGTHS INCHES (mm)	WIRE SEALING RANGE INCHES (mm)		WIRE HOLE FILLER
		PINS		SOCKETS			MIN.	MAX.	
		SILVER	GOLD	SILVER	GOLD				
12	RG161/U RG174A/U RG179B/U RG187A/U RG188A/U RG316/U	21-33034-1	21-33014-21 21-33048-1(1) 21-33130-1(1)	21-33033-1	21-33013-21 21-33047-1(1) 21-33129-1(1)	Contact us for details	0.126 (3.2)	0.177 (4.5)	Yellow 10-405996-12
	RG178B/U RG196A/U	-	21-33014-22	-	21-33013-22				
8	RG58C/U RG141A/U RG303/U	21-33034-2(1)	21-33014-1(5) 21-33016-5(3) 21-33130-2(1)	21-33033-2(1) 21-33048-2(1)	21-33013-1(5) 21-33047-2(1) 21-33015-5(3) 21-33129-2(1)	Contact us for details	0.150 (3.8)	0.256 (6.5)	White 10-405996-8
	RG59B/U RG62A/U RG62B/U RG210/U	21-33034-5(1)	21-33014-5(5) 21-33016-2(3) 21-33130-5(1) 21-33064-21(1)	21-33033-5(1)	21-33013-5(5) 21-33015-2(3) 21-33129-3(1) 21-33063-21(1)				
	RG161/U RG174A/U RG179B/U RG187A/U RG188A/U RG316/U	21-33034-3(1)	21-33014-3(5) 21-33016-1(3) 21-33130-3(1) 21-33064-20(1)	21-33033-3(1)	21-33013-3(5) 21-33015-1(3) 21-33129-3(1) 21-33063-20(1)				
	RG180B/U RG195A/U	21-33034-6	21-33014-6(5) 21-33048-3(1) 21-33130-6(1)	21-33033-6	21-33013-6(1) 21-33047-3(1) 21-33129-6(1)				
	RG140/U RG302/U	21-33034-8	21-33014-8(5) 21-33033-8(1) 21-33130-8(1)	21-33033-8	21-33013-8(5) 21-33129-8(1)				
	RG55B/U RG142A/U RG142B/U RG223/U	21-33034-4	21-33014-5(5) 21-33130-4(1)	21-33033-4	21-33013-5(5) 21-33129-4(1)				
4	RG59B/U RG62A/U RG62B/U RG210/U		21-33060-10(1)		21-33059-10(1)	Contact us for details	0.279 (7.1)	0.366 (9.3)	Blue 10-405996-4
	RG212/U	-	21-33060-11(1)	-	21-33059-11(1)				
	RG55B/U RG142A/U RG142B/U RG223/U		31-33060-12(1)		21-33059-12(1)				

() Various platings available. Availability of coax contacts varies widely. Contact us for details. All dimensions in inches (millimeters in parenthesis)

TOOLS

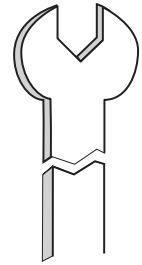

Crimp Dies

COAX CONTACT SIZE	COAX WIRE SIZE	HAND-CRIMP TOOL	CRIMP DIES	USE LOCATOR	COAX CLAMP NUT WRENCH
12	RG161/U RG174A/U RG179B/U RG187A/U RG188A/U RG316/U	M22520/10-01	M22520/10-05	A	11-8676-1
	RG178B/U RG196A/U			B	
8	RG58C/U RG141A/U RG303/U	M22520/10-01	M22520/10-07	B	11-8676-2
	RG59B/U RG62A/U RG62B/U RG210/U	M22520/5-01	M22520/5-45	B	11-8676-3
	RG161/U RG174A/U RG179B/U RG187A/U RG188A/U RG316/U	M22520/10-01	M22520/10-05	A	11-8676-2
	RG180B/U RG195A/U			B	
	RG140/U RG302/U		M22520/10-07	A	
	RG55B/U RG142A/U RG142B/U RG223/U				
	4	RG59B/U RG62A/U RG62B/U RG210/U	M22520/5-01	M22520/5-45	B
RG212/U		M22520/5-01	M22520/5-39	A	
RG55B/U RG142A/U RG142B/U RG223/U		M22520/10-01	M22520/10-07	A	

All dimensions in inches (millimeters in parenthesis)

COMPONENTS				
PLUGS		RECEPTACLES		
	AIB/GT	AIBC/ACA-B	AIB/GT	AIBC/ACA-B
O-Ring				
Barrel/Shell				
Insert/Insulator				
Contacts				
Wave Spring and Skid Washer (Optional)				
Coupling Nut				
Individual Wire Sealing Grommet				
Ferrule/Sleeve Compression Ring				
Endbell/Backshell/Cable Clamp				

PRINTED CIRCUIT CONTACTS

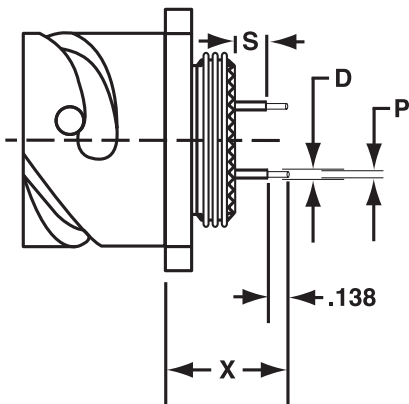

SHELL SIZE	H SERIES	
	S	X
10SL	.188 (4.78)	.567 (14.40)
14S	.188 (4.78)	.567 (14.40)
16S	.188 (4.78)	.567 (14.40)
16	.188 (4.78)	.622 (15.80)
18	.188 (4.78)	.622 (15.80)
20	.188 (4.78)	.622 (15.80)
22	.188 (4.78)	.622 (15.80)
24	.188 (4.78)	.622 (15.80)
28	.188 (4.78)	.657 (16.69)
32	.188 (4.78)	.720 (18.29)
36	.188 (4.78)	.720 (18.29)
40	.188 (4.78)	.720 (18.29)

CONTACT SIZE	D	P
12	.134 (3.4)	.070 (1.78)
16	.063 (1.6)	.030 (0.76)

All dimensions in inches (millimeters in parenthesis)

DIMENSIONS

STYLE 0, 2, 30 RECEPTACLES

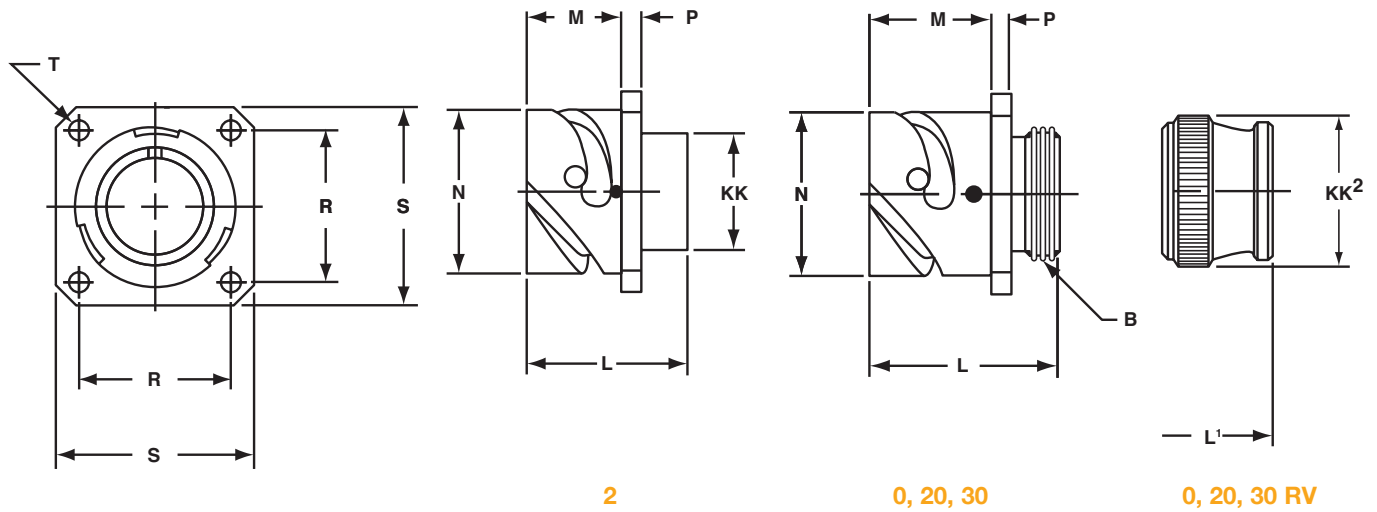

SHELL SIZE	M +.016-.000 (+0.4-0.0)	N +.000-.006 (+0.00-0.15)	P ± .008 (±0.2)	R ± .004 (±0.1)	S ± .012 (±0.3)	T +.004-.000 (+0.1-0.0)	KK MAX.	B THREAD CLASS 2A	L + .012 (+ 0.3)	L ¹ MAX.	KK ² MAX.
10SL	.717 (18.2)	.717 (18.2)	.110 (2.8)	.717 (18.2)	1.000 (25.4)	.126 (3.2)	.626 (15.9)	.6250-24 UNEF	1.087 (27.6)	1.890 (48.0)	.787 (20.0)
14S	.717 (18.2)	.969 (24.6)	.126 (3.2)	.906 (23.0)	1.181 (30.0)	.126 (3.2)	.756 (19.2)	.7500-20 UNEF	1.087 (27.6)	1.890 (48.0)	.945 (24.0)
16S	.717 (18.2)	1.079 (27.4)	.126 (3.2)	.969 (24.6)	1.280 (32.5)	.126 (3.2)	.882 (22.4)	.8750-20 UNEF	1.087 (27.6)	1.890 (48.0)	1.024 (26.0)
16	.846 (21.5)	1.079 (27.4)	.126 (3.2)	.969 (24.6)	1.280 (32.5)	.126 (3.2)	.882 (22.4)	.8750-20 UNEF	1.331 (33.8)	2.205 (56.0)	1.024 (26.0)
18	.907 (23.1)	1.213 (30.8)	.157 (4.0)	1.063 (27.0)	1.378 (35.0)	.126 (3.2)	1.008 (25.6)	1.0000-20 UNEF	1.331 (33.8)	2.244 (57.0)	1.161 (29.5)
20	.907 (23.1)	1.346 (34.2)	.157 (4.0)	1.157 (29.4)	1.496 (38.0)	.126 (3.2)	1.142 (29.0)	1.1250-18 UNEF	1.331 (33.8)	2.244 (57.0)	1.299 (33.0)
22	.907 (23.1)	1.472 (37.4)	.157 (4.0)	1.252 (31.8)	1.614 (41.0)	.126 (3.2)	1.268 (32.2)	1.2500-18 UNEF	1.331 (33.8)	2.244 (57.0)	1.417 (36.0)
24	.907 (23.1)	1.610 (40.9)	.157 (4.0)	1.374 (34.9)	1.752 (44.5)	.146 (3.7)	1.390 (35.3)	1.3750-18 UNEF	1.331 (33.8)	2.244 (57.0)	1.575 (40.0)
28	.947 (24.1)	1.839 (46.7)	.157 (4.0)	1.563 (39.7)	2.000 (50.8)	.146 (3.7)	1.630 (41.4)	1.6250-18 UNEF	1.406 (35.7)	2.244 (57.0)	1.811 (46.0)
32	.947 (24.1)	2.102 (53.4)	.157 (4.0)	1.752 (44.5)	2.244 (57.0)	.169 (4.3)	1.882 (47.8)	1.8750-16 UN	1.469 (37.3)	2.362 (60.0)	2.028 (51.5)
36	.947 (24.1)	2.346 (59.6)	.157 (4.0)	1.937 (49.2)	2.500 (63.5)	.169 (4.3)	2.063 (52.4)	2.0625-16 UN	1.469 (37.3)	2.362 (60.0)	2.283 (58.0)
40	.947 (24.1)	2.579 (65.5)	.157 (4.0)	2.185 (55.5)	2.752 (69.9)	.169 (4.3)	2.323 (59.0)	2.3125-16 UN	1.469 (37.3)	2.362 (60.0)	2.539 (64.5)

All dimensions in inches (millimeters in parenthesis)

STYLE 0, 20, 30 RECEPTACLES

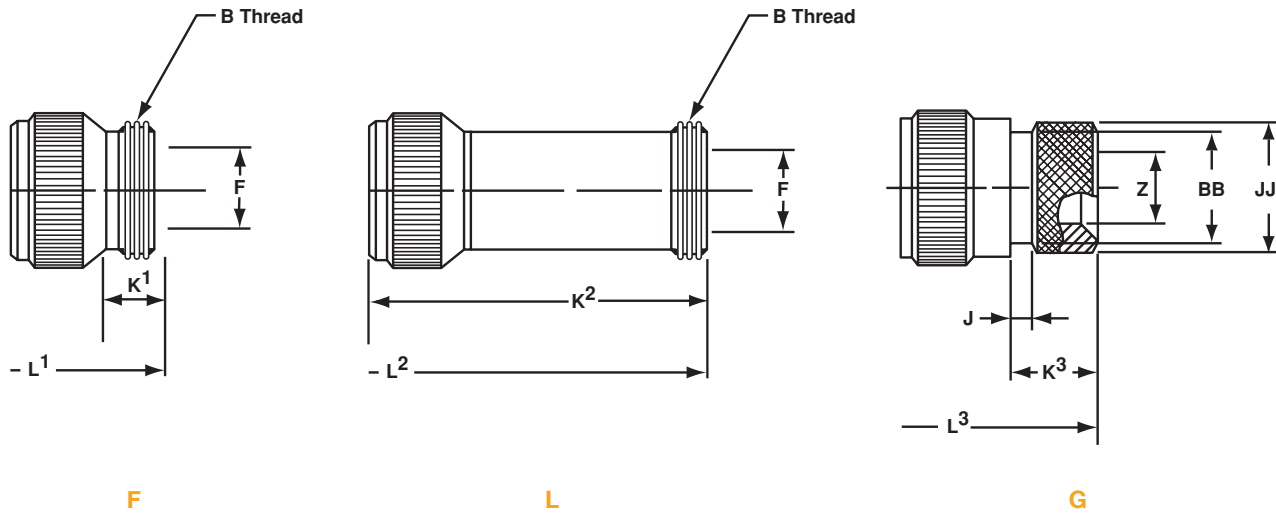

B THREAD CLASS 2A	F MIN.	K ¹ MIN.	K ² MIN.	L ² MAX.	L ³ MAX.	J ± .008 (±0.2)	K ³ + .020 (±0.5)	L ⁴ MAX.	Z MIN.	BB MAX.	JJ + .008 (+0.2)
.6250-24 UNEF	.409 (10.4)	.374 (9.5)	2.110 (53.6)	1.969 (50.0)	3.197 (81.2)	.138 (3.5)	.461 (11.7)	1.969 (50.0)	.303 (7.7)	.524 (13.3)	.610 (15.5)
.7500-20 UNEF	.520 (13.2)	.374 (9.5)	2.145 (54.5)	1.969 (50.0)	3.232 (82.1)	.138 (3.5)	.461 (11.7)	1.969 (50.0)	.417 (10.6)	.669 (17.0)	.752 (19.1)
.8750-20 UNEF	.638 (16.2)	.374 (9.5)	2.145 (54.5)	1.969 (50.0)	3.232 (82.1)	.138 (3.5)	.461 (11.7)	1.969 (50.0)	.531 (13.5)	.862 (21.9)	.941 (23.9)
.8750-20 UNEF	.638 (16.2)	.374 (9.5)	2.240 (56.9)	2.362 (60.0)	3.571 (90.7)	.138 (3.5)	.453 (11.5)	2.362 (60.0)	.531 (13.5)	.862 (21.9)	.941 (23.9)
1.0000-20 UNEF	.756 (19.2)	.374 (9.5)	2.315 (58.8)	2.362 (60.0)	3.646 (92.6)	.138 (3.5)	.453 (11.5)	2.362 (60.0)	.575 (14.6)	.862 (21.9)	.941 (23.9)
1.1875-18 UNEF	.867 (22.0)	.374 (9.5)	2.300 (58.4)	2.362 (60.0)	3.631 (92.2)	.138 (3.5)	.500 (12.7)	2.559 (65.0)	.736 (18.7)	1.031 (26.2)	1.165 (29.6)
1.1875-18 UNEF	.965 (24.5)	.374 (9.5)	2.305 (58.5)	2.362 (60.0)	3.636 (92.4)	.138 (3.5)	.500 (12.7)	2.559 (65.0)	.819 (20.8)	1.031 (26.2)	1.165 (29.6)
1.4375-18 UNEF	1.094 (27.8)	.374 (9.5)	2.320 (58.9)	2.560 (65.0)	3.651 (92.7)	.138 (3.5)	.500 (12.7)	2.559 (65.0)	.969 (24.6)	1.358 (34.5)	1.488 (37.8)
1.4375-18 UNEF	1.228 (31.2)	.374 (9.5)	2.490 (63.2)	2.560 (65.0)	3.896 (99.0)	.138 (3.5)	.500 (12.7)	2.559 (65.0)	1.063 (27.0)	1.358 (34.5)	1.488 (37.8)
1.7500-18 UNS	1.488 (37.8)	.433 (11.0)	2.635 (66.9)	2.560 (65.0)	4.104 (104.2)	.138 (3.5)	.598 (15.2)	2.756 (70.0)	1.311 (33.3)	1.717 (43.6)	1.882 (47.8)
2.0000-18 UNS	1.780 (45.2)	.465 (11.8)	2.680 (68.1)	3.150 (80.0)	4.149 (105.4)	.138 (3.5)	.598 (15.2)	3.150 (80.0)	1.516 (38.5)	1.717 (43.6)	1.882 (47.8)
2.2500-16 UN	2.016 (51.2)	.465 (11.8)	2.680 (68.1)	3.150 (80.0)	4.149 (105.4)	.138 (3.5)	.610 (15.5)	3.150 (80.0)	1.898 (48.2)	2.071 (52.6)	2.276 (57.8)

All dimensions in inches (millimeters in parenthesis)

STYLE 1 CABLE RECEPTACLE

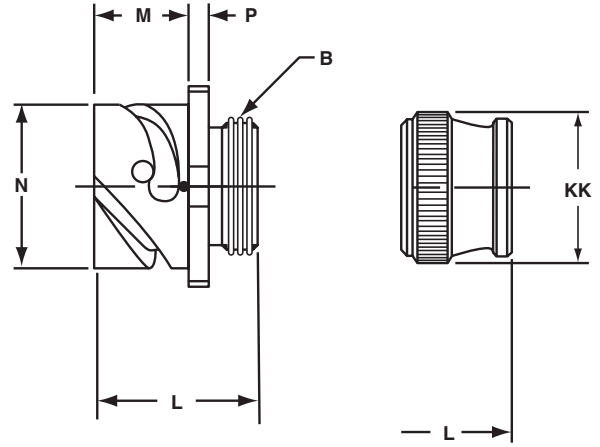
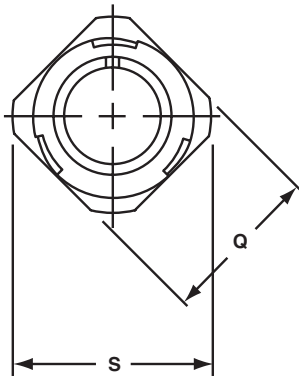

RV

SHELL SIZE	M +.016 -.000 (+0.4 - 0.0)	N +.000 -.006 (+0.00-0.15)	P ± .008 (±0.2)	Q ± .008 (±0.2)	S MAX.
10SL	.717 (18.2)	.717 (18.2)	.110 (2.8)	.811 (20.6)	.992 (25.2)
14S	.717 (18.2)	.969 (24.6)	.126 (3.2)	1.000 (25.4)	1.173 (29.8)
16S	.717 (18.2)	1.079 (27.4)	.126 (3.2)	1.126 (28.6)	1.272 (32.3)
16	.846 (21.5)	1.079 (27.4)	.126 (3.2)	1.126 (28.6)	1.272 (32.3)
18	.907 (23.0)	1.213 (30.8)	.157 (4.0)	1.248 (31.7)	1.370 (34.8)
20	.907 (23.0)	1.346 (34.2)	.157 (4.0)	1.374 (34.9)	1.488 (37.8)
22	.907 (23.0)	1.472 (37.4)	.157 (4.0)	1.500 (38.1)	1.618 (41.1)
24	.907 (23.0)	1.610 (40.9)	.157 (4.0)	1.626 (41.3)	1.756 (44.6)
28	.947 (24.1)	1.839 (46.7)	.157 (4.0)	1.874 (47.6)	2.004 (50.9)
32	.947 (24.1)	2.102 (53.4)	.157 (4.0)	2.126 (54.0)	2.248 (57.1)
36	.947 (24.1)	2.346 (59.6)	.157 (4.0)	2.386 (60.6)	2.504 (63.6)
40	.947 (24.1)	2.579 (65.5)	.157 (4.0)	2.618 (66.5)	2.756 (70.0)

B THREAD CLASS 2A	L + .012 (+ 0.3)
.6250-24 UNEF	1.087 (27.6)
.7500-20 UNEF	1.087 (27.6)
.8750-20 UNEF	1.087 (27.6)
.8750-20 UNEF	1.331 (33.8)
1.0000-20 UNEF	1.331 (33.8)
1.1250-18 UNEF	1.331 (33.8)
1.2500-18 UNEF	1.331 (33.8)
1.3750-18 UNEF	1.331 (33.8)
1.6250-18 UNEF	1.406 (35.7)
1.8750-16 UN	1.469 (37.3)
2.0625-16 UN	1.469 (37.3)
2.3125-16 UN	1.469 (37.3)

L ¹ MAX.	KK MAX.
1.890 (48.0)	.787 (20.0)
1.890 (48.0)	.945 (24.0)
1.890 (48.0)	1.024 (26.0)
2.205 (56.0)	1.024 (26.0)
2.244 (57.0)	1.161 (29.5)
2.244 (57.0)	1.299 (33.0)
2.244 (57.0)	1.417 (36.0)
2.244 (57.0)	1.575 (40.0)
2.244 (57.0)	1.811 (46.0)
2.362 (60.0)	2.028 (51.5)
2.362 (60.0)	2.283 (58.0)
2.362 (60.0)	2.539 (64.5)

All dimensions in inches (millimeters in parenthesis)

STYLE 1 CABLE RECEPTACLE

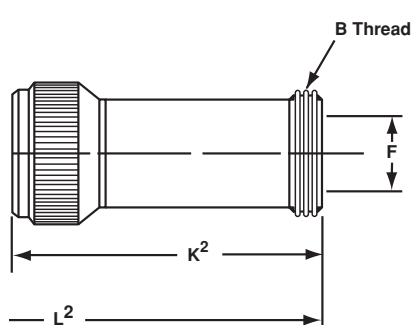

L

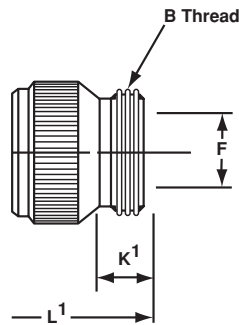

F

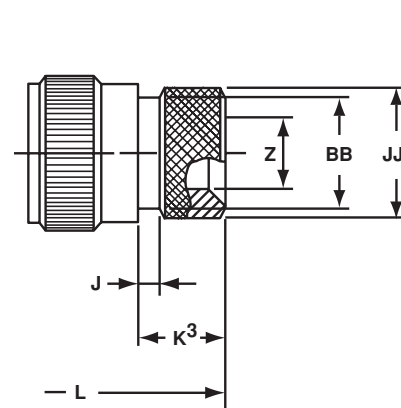

G

B THREAD CLASS 2A	F MIN.	K ¹ MIN.	K ² MAX.	L ³ MAX.	L ² MAX.
.6250-24 UNEF	.409 (10.4)	.374 (9.5)	2.110 (53.6)	1.969 (50.0)	3.197 (81.2)
.7500-20 UNEF	.520 (13.2)	.374 (9.5)	2.145 (54.5)	1.969 (50.0)	3.232 (82.1)
.8750-20 UNEF	.638 (16.2)	.374 (9.5)	2.145 (54.5)	1.969 (50.0)	3.232 (82.1)
.8750-20 UNEF	.638 (16.2)	.374 (9.5)	2.240 (56.9)	2.362 (60.0)	3.571 (90.7)
1.0000-20 UNEF	.756 (19.2)	.374 (9.5)	2.315 (58.8)	2.362 (60.0)	3.646 (92.6)
1.1875-18 UNEF	.867 (22.0)	.374 (9.5)	2.300 (58.4)	2.362 (60.0)	3.631 (92.2)
1.1875-18 UNEF	.965 (24.5)	.374 (9.5)	2.305 (58.5)	2.362 (60.0)	3.636 (92.4)
1.4375-18 UNEF	1.094 (27.8)	.374 (9.5)	2.320 (58.9)	2.560 (65.0)	3.651 (92.7)
1.4375-18 UNEF	1.228 (31.2)	.374 (9.5)	2.490 (63.2)	2.560 (65.0)	3.896 (99.0)
1.7500-18 UNS	1.488 (37.8)	.433 (11.0)	2.635 (66.9)	2.560 (65.0)	4.104 (104.2)
2.0000-18 UNS	1.780 (45.2)	.465 (11.8)	2.680 (68.1)	3.150 (80.0)	4.149 (105.4)
2.2500-16 UN	2.016 (51.2)	.465 (11.8)	2.680 (68.1)	3.150 (80.0)	4.149 (105.4)

J ± .008 (±0.2)	K ³ + .020 (±0.5)	L ⁴ MAX.	Z MIN.	BB MAX.	JJ + .008 (+0.2)
.138 (3.5)	.461 (11.7)	1.969 (50.0)	.303 (7.7)	.524 (13.3)	.610 (15.5)
.138 (3.5)	.461 (11.7)	1.969 (50.0)	.417 (10.6)	.669 (17.0)	.752 (19.1)
.138 (3.5)	.461 (11.7)	1.969 (50.0)	.531 (13.5)	.862 (21.9)	.941 (23.9)
.138 (3.5)	.453 (11.5)	2.362 (60.0)	.531 (13.5)	.862 (21.9)	.941 (23.9)
.138 (3.5)	.453 (11.5)	2.362 (60.0)	.575 (14.6)	.862 (21.9)	.941 (23.9)
.138 (3.5)	.500 (12.7)	2.559 (65.0)	.736 (18.7)	1.031 (26.2)	1.165 (29.6)
.138 (3.5)	.500 (12.7)	2.559 (65.0)	.819 (20.8)	1.031 (26.2)	1.165 (29.6)
.138 (3.5)	.500 (12.7)	2.559 (65.0)	.969 (24.6)	1.358 (34.5)	1.488 (37.8)
.138 (3.5)	.500 (12.7)	2.559 (65.0)	1.063 (27.0)	1.358 (34.5)	1.488 (37.8)
.138 (3.5)	.598 (15.2)	2.756 (70.0)	1.311 (33.3)	1.717 (43.6)	1.882 (47.8)
.138 (3.5)	.598 (15.2)	3.150 (80.0)	1.516 (38.5)	1.717 (43.6)	1.882 (47.8)
.138 (3.5)	.610 (15.5)	3.150 (80.0)	1.898 (48.2)	2.071 (52.6)	2.276 (57.8)

All dimensions in inches (millimeters in parenthesis)

STYLE 4 RUBBER-COVERED PLUGS

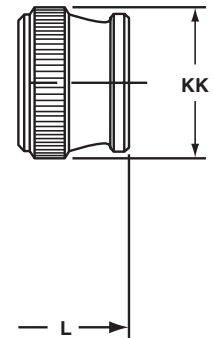
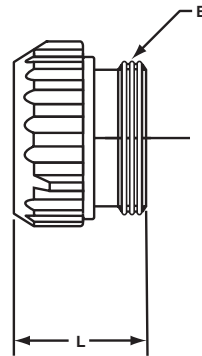
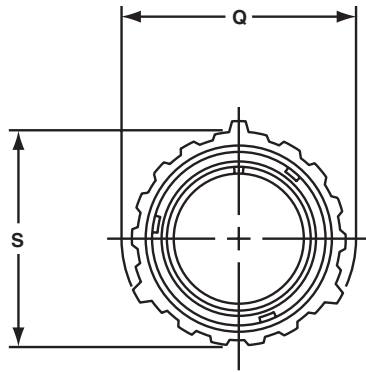

RV

SHELL SIZE	Q MAX.	S MAX.
10SL	1.319 (33.5)	1.122 (28.5)
18	1.929 (49.0)	1.713 (43.5)
20	2.028 (51.5)	1.811 (46.0)
22	2.224 (56.5)	1.988 (50.5)
24	2.362 (60.0)	2.126 (54.0)
28	2.638 (67.0)	2.402 (61.0)
32	2.992 (76.0)	2.661 (67.6)
36	3.240 (82.3)	2.925 (74.3)
40	3.465 (88.0)	3.150 (80.0)

B THREAD CLASS 2A	L + .012 (+ 0.3)
.6250-24 UNEF	1.087 (27.6)
1.0000-20 UNEF	1.331 (33.8)
1.1250-18 UNEF	1.331 (33.8)
1.2500-18 UNEF	1.331 (33.8)
1.3750-18 UNEF	1.331 (33.8)
1.6250-18 UNEF	1.406 (35.7)
1.8750-16 UN	1.469 (37.3)
2.0625-16 UN	1.469 (37.3)
2.3125-16 UN	1.469 (37.3)

L ¹ MAX.	KK MAX.
1.417 (36.0)	.787 (20.0)
1.929 (49.0)	1.161 (29.5)
1.969 (50.0)	1.299 (33.0)
1.969 (50.0)	1.417 (36.0)
2.008 (51.0)	1.575 (40.0)
2.008 (51.0)	1.811 (46.0)
2.087 (53.0)	2.028 (51.5)
2.106 (53.5)	2.283 (58.0)
2.126 (54.0)	2.539 (64.5)

All dimensions in inches (millimeters in parenthesis)

STYLE 4 RUBBER-COVERED PLUGS

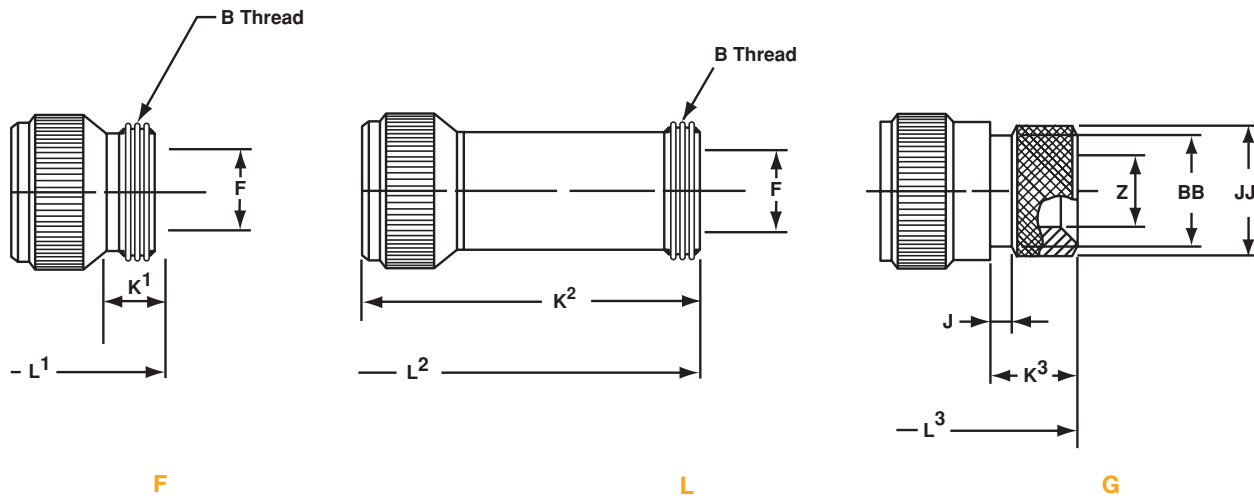

B THREAD CLASS 2A	F MIN.	K ¹ MIN.	K ² MIN.	L ² MAX.	L ³ MAX.
.6250-24 UNEF	.409 (10.4)	.374 (9.5)	2.110 (53.6)	1.969 (50.0)	3.197 (81.2)
1.0000-20 UNEF	.756 (19.2)	.374 (9.5)	2.315 (58.8)	2.362 (60.0)	3.646 (92.6)
1.1875-18 UNEF	.867 (22.0)	.374 (9.5)	2.300 (58.4)	2.362 (60.0)	3.631 (92.2)
1.1875-18 UNEF	.965 (24.5)	.374 (9.5)	2.305 (58.5)	2.362 (60.0)	3.636 (92.4)
1.4375-18 UNEF	1.094 (27.8)	.374 (9.5)	2.320 (58.9)	2.560 (65.0)	3.651 (92.7)
1.4375-18 UNEF	1.228 (31.2)	.374 (9.5)	2.490 (63.2)	2.560 (65.0)	3.896 (99.0)
1.7500-18 UNS	1.488 (37.8)	.433 (11.0)	2.635 (66.9)	2.560 (65.0)	4.104 (104.2)
2.0000-18 UNS	1.780 (45.2)	.465 (11.8)	2.680 (68.1)	3.150 (80.0)	4.149 (105.4)
2.2500-16 UN	2.016 (51.2)	.465 (11.8)	2.680 (68.1)	3.150 (80.0)	4.149 (105.4)

J ± .008 (±0.2)	K ³ + .020 (±0.5)	L ⁴ MAX.	Z MIN.	BB MAX.	JJ + .008 (+0.2)
.138 (3.5)	.461 (11.7)	1.969 (50.0)	.303 (7.7)	.524 (13.3)	.610 (15.5)
.138 (3.5)	.453 (11.5)	2.362 (60.0)	.575 (14.6)	.862 (21.9)	.941 (23.9)
.138 (3.5)	.500 (12.7)	2.559 (65.0)	.736 (18.7)	1.031 (26.2)	1.165 (29.6)
.138 (3.5)	.500 (12.7)	2.559 (65.0)	.819 (20.8)	1.031 (26.2)	1.165 (29.6)
.138 (3.5)	.500 (12.7)	2.559 (65.0)	.969 (24.6)	1.358 (34.5)	1.488 (37.8)
.138 (3.5)	.500 (12.7)	2.559 (65.0)	1.063 (27.0)	1.358 (34.5)	1.488 (37.8)
.138 (3.5)	.598 (15.2)	2.756 (70.0)	1.311 (33.3)	1.717 (43.6)	1.882 (47.8)
.138 (3.5)	.598 (15.2)	3.150 (80.0)	1.516 (38.5)	1.717 (43.6)	1.882 (47.8)
.138 (3.5)	.610 (15.5)	3.150 (80.0)	1.898 (48.2)	2.071 (52.6)	2.276 (57.8)

All dimensions in inches (millimeters in parenthesis)

DIMENSIONS

STYLE 6, 6HD PLUGS

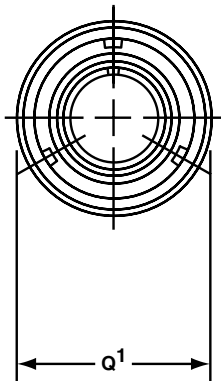

6

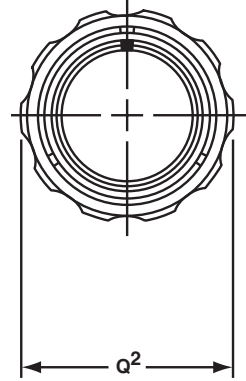

6HD

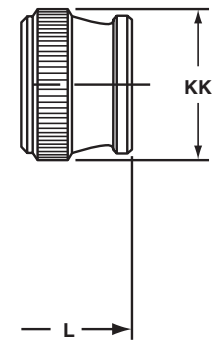
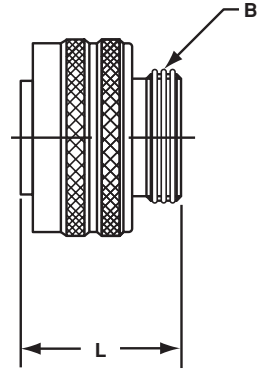

RV

SHELL SIZE	Q ¹ MAX.	Q ² MAX.
10SL	.898 (22.8)	1.007 (25.5)
14S	1.150 (29.2)	1.259 (31.9)
16S	1.260 (32.0)	1.410 (35.8)
16	1.260 (32.0)	1.410 (35.8)
18	1.437 (36.5)	1.547 (39.2)
20	1.571 (39.9)	1.681 (42.6)
22	1.697 (43.1)	1.847 (46.9)
24	1.835 (46.6)	1.965 (49.9)
28	2.102 (53.4)	2.222 (56.4)
32	2.366 (60.1)	2.482 (63.0)
36	2.610 (66.3)	2.721 (69.1)
40	2.850 (72.4)	2.953 (75.0)

B THREAD CLASS 2A	L + .012 (+ 0.3)
.6250-24 UNEF	1.087 (27.6)
.7500-20 UNEF	1.087 (27.6)
.8750-20 UNEF	1.087 (27.6)
.8750-20 UNEF	1.331 (33.8)
1.0000-20 UNEF	1.331 (33.8)
1.1250-18 UNEF	1.331 (33.8)
1.2500-18 UNEF	1.331 (33.8)
1.3750-18 UNEF	1.331 (33.8)
1.6250-18 UNEF	1.406 (35.7)
1.8750-16 UN	1.469 (37.3)
2.0625-16 UN	1.469 (37.3)
2.3125-16 UN	1.469 (37.3)

L ¹ MAX.	KK MAX.
1.417 (36.0)	.787 (20.0)
1.437 (36.5)	.945 (24.0)
1.437 (36.5)	1.024 (26.0)
1.929 (49.0)	1.024 (26.0)
1.929 (49.0)	1.161 (29.5)
1.969 (50.0)	1.299 (33.0)
1.969 (50.0)	1.417 (36.0)
2.008 (51.0)	1.543 (39.2)
2.008 (51.0)	1.811 (46.0)
2.087 (53.0)	2.028 (51.5)
2.106 (53.5)	2.283 (58.0)
2.126 (54.0)	2.539 (64.5)

All dimensions in inches (millimeters in parenthesis)

STYLE 6, 6HD PLUGS

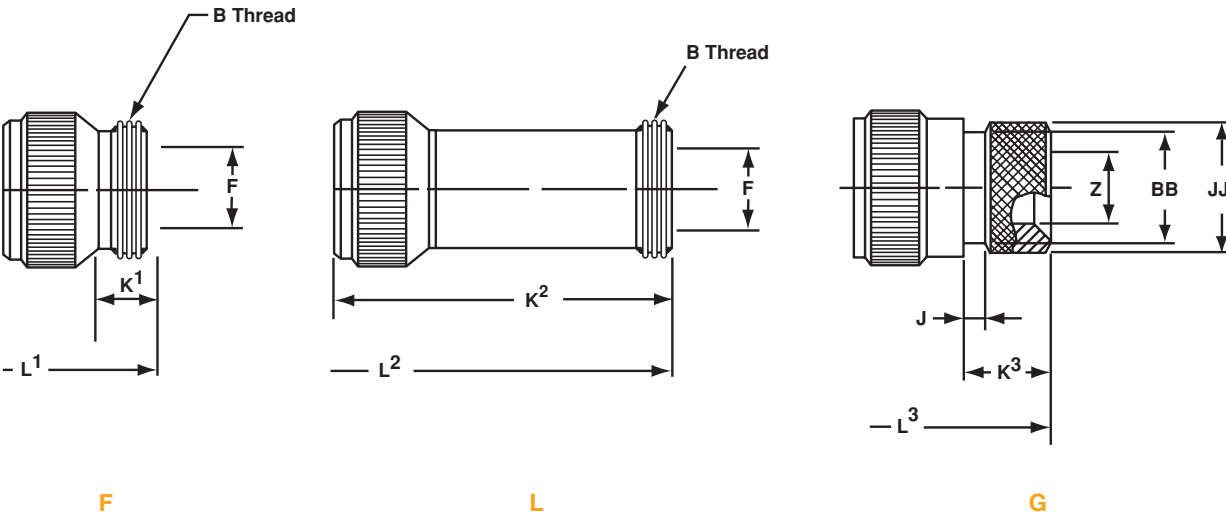

B THREAD CLASS 2A	F MIN.	K ¹ MIN.	K ² MIN.	L ² MAX.	L ³ MAX.
.6250-24 UNEF	.409 (10.4)	.374 (9.5)	2.110 (53.6)	1.969 (50.0)	3.197 (81.2)
.7500-20 UNEF	.520 (13.2)	.374 (9.5)	2.145 (54.5)	1.969 (50.0)	3.232 (82.1)
.8750-20 UNEF	.638 (16.2)	.374 (9.5)	2.145 (54.5)	1.969 (50.0)	3.232 (82.1)
.8750-20 UNEF	.638 (16.2)	.374 (9.5)	2.240 (56.9)	2.362 (60.0)	3.571 (90.7)
1.0000-20 UNEF	.756 (19.2)	.374 (9.5)	2.315 (58.8)	2.362 (60.0)	3.646 (92.6)
1.1875-18 UNEF	.867 (22.0)	.374 (9.5)	2.300 (58.4)	2.362 (60.0)	3.631 (92.2)
1.1875-18 UNEF	.965 (24.5)	.374 (9.5)	2.305 (58.5)	2.362 (60.0)	3.636 (92.4)
1.4375-18 UNEF	1.094 (27.8)	.374 (9.5)	2.320 (58.9)	2.560 (65.0)	3.651 (92.7)
1.4375-18 UNEF	1.228 (31.2)	.374 (9.5)	2.490 (63.2)	2.560 (65.0)	3.896 (99.0)
1.7500-18 UNS	1.488 (37.8)	.433 (11.0)	2.635 (66.9)	2.560 (65.0)	4.104 (104.2)
2.0000-18 UNS	1.780 (45.2)	.465 (11.8)	2.680 (68.1)	3.150 (80.0)	4.149 (105.4)
2.2500-16 UN	2.016 (51.2)	.465 (11.8)	2.680 (68.1)	3.150 (80.0)	4.149 (105.4)

J ± .008 (±0.2)	K ³ + .020 (±0.5)	L ⁴ MAX.	Z MIN.	BB MAX.	JJ + .008 (+0.2)
.138 (3.5)	.461 (11.7)	1.969 (50.0)	.303 (7.7)	.524 (13.3)	.610 (15.5)
.138 (3.5)	.461 (11.7)	1.969 (50.0)	.417 (10.6)	.669 (17.0)	.752 (19.1)
.138 (3.5)	.461 (11.7)	1.969 (50.0)	.531 (13.5)	.862 (21.9)	.941 (23.9)
.138 (3.5)	.453 (11.5)	2.362 (60.0)	.531 (13.5)	.862 (21.9)	.941 (23.9)
.138 (3.5)	.453 (11.5)	2.362 (60.0)	.575 (14.6)	.862 (21.9)	.941 (23.9)
.138 (3.5)	.500 (12.7)	2.559 (65.0)	.736 (18.7)	1.031 (26.2)	1.165 (29.6)
.138 (3.5)	.500 (12.7)	2.559 (65.0)	.819 (20.8)	1.031 (26.2)	1.165 (29.6)
.138 (3.5)	.500 (12.7)	2.559 (65.0)	.969 (24.6)	1.358 (34.5)	1.488 (37.8)
.138 (3.5)	.500 (12.7)	2.559 (65.0)	1.063 (27.0)	1.358 (34.5)	1.488 (37.8)
.138 (3.5)	.598 (15.2)	2.756 (70.0)	1.311 (33.3)	1.717 (43.6)	1.882 (47.8)
.138 (3.5)	.598 (15.2)	3.150 (80.0)	1.516 (38.5)	1.717 (43.6)	1.882 (47.8)
.138 (3.5)	.610 (15.5)	3.150 (80.0)	1.898 (48.2)	2.071 (52.6)	2.276 (57.8)

All dimensions in inches (millimeters in parenthesis)

PLUG STYLE 6, 6HD RIGHT ANGLE

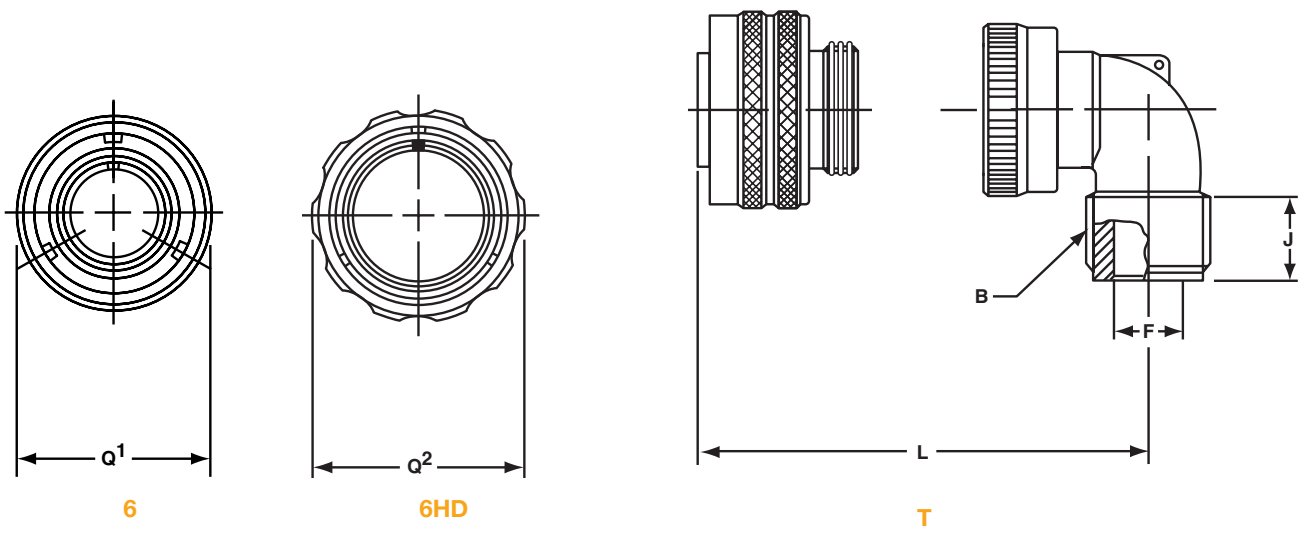

SHELL SIZE	Q ¹ MAX.	Q ² MAX.
10SL	.898 (22.8)	1.007 (25.5)
14S	1.150 (29.2)	1.259 (31.9)
16S	1.260 (32.0)	1.410 (35.8)
16	1.260 (32.0)	1.410 (35.8)
18	1.437 (36.5)	1.547 (39.2)
20	1.571 (39.9)	1.681 (42.6)
22	1.697 (43.1)	1.847 (46.9)
24	1.835 (46.6)	1.965 (49.9)
28	2.102 (53.4)	2.222 (56.4)
32	2.366 (60.1)	2.482 (63.0)
36	2.610 (66.3)	2.721 (69.1)
40	2.850 (72.4)	2.953 (75.0)

B THREAD CLASS 2A	F MAX.	J MIN.	K MAX.	L MAX.
.6250-24 UNEF	.337 (8.5)	.370 (9.4)	1.181 (30.0)	1.772 (45.0)
.7500-20 UNEF	.462 (11.7)	.370 (9.4)	1.181 (30.0)	1.850 (47.0)
.8750-20 UNEF	.587 (14.9)	.370 (9.4)	1.181 (30.0)	1.890 (48.0)
.8750-20 UNEF	.587 (14.9)	.370 (9.4)	1.181 (30.0)	2.244 (57.0)
1.0000-20 UNEF	.685 (17.4)	.370 (9.4)	1.378 (35.0)	2.283 (58.0)
1.1875-18 UNEF	.810 (20.5)	.370 (9.4)	1.378 (35.0)	2.402 (61.0)
1.1875-18 UNEF	.915 (23.2)	.370 (9.4)	1.378 (35.0)	2.402 (61.0)
1.4375-18 UNEF	1.025 (26.0)	.370 (9.4)	1.575 (40.0)	2.598 (66.0)
1.4375-18 UNEF	1.139 (28.9)	.370 (9.4)	1.575 (40.0)	2.598 (53.4)
1.7500-18 UNS	1.447 (36.7)	.433 (11.0)	1.772 (45.0)	2.835 (72.0)
2.0000-18 UNS	1.687 (42.8)	.496 (12.6)	1.969 (50.0)	2.953 (75.0)
2.2500-16 UN	1.923 (48.8)	.496 (12.6)	2.165 (55.1)	3.071 (78.0)

All dimensions in inches (millimeters in parenthesis)

6B PANEL PLUG

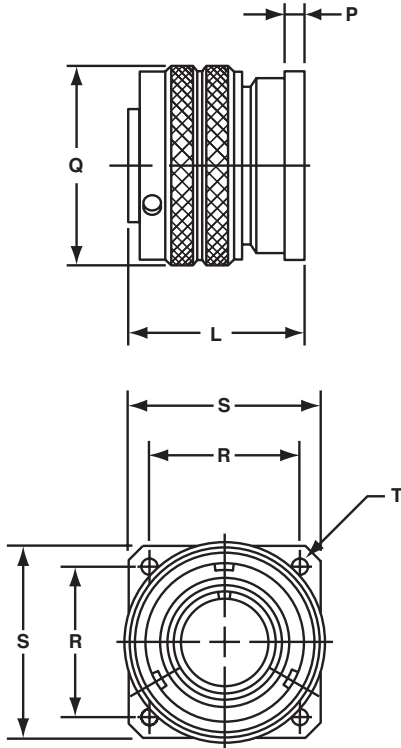

6B

STYLE TB THRU-BULKHEAD RECEPTACLE

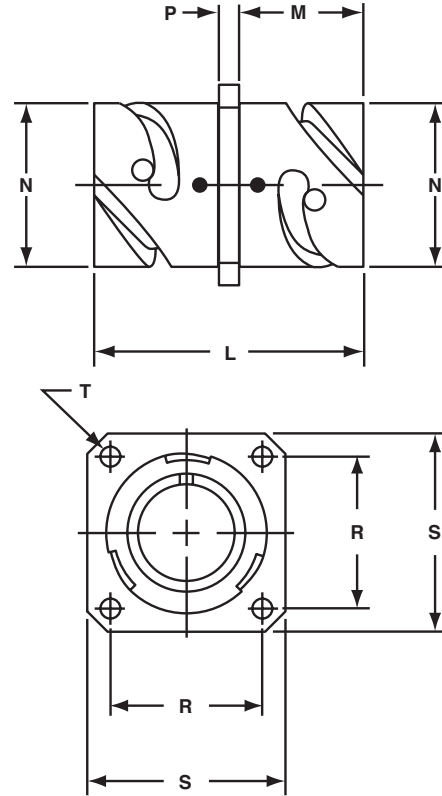

TB

SHELL SIZE	L APPROX.	Q MAX.	P ±.008 (±0.2)	R ±.004 (±0.1)	S ±.012 (±0.3)	T +.004-.000 (+0.1-0.0)	L MAX.	M +.016-.000 (+0.4-0.0)	N +.000-.006 (+0.00-0.15)	P ±.008 (±0.2)	R ±.004 (±0.1)	S ±.012 (±0.3)	T +.004-.000 (+0.1-0.0)
10SL	1.087 (27.6)	.898 (22.8)	.110 (2.8)	.717 (18.2)	1.000 (25.4)	.126 (3.2)	1.488 (37.7)	.717 (18.2)	.717 (18.2)	.110 (2.8)	.717 (18.2)	1.000 (25.4)	.126 (3.2)
14S	1.091 (27.7)	1.150 (29.2)	.126 (3.2)	.906 (23.0)	1.181 (30.0)	.126 (3.2)	1.488 (37.7)	.717 (18.2)	.969 (24.6)	.126 (3.2)	.906 (23.0)	1.181 (30.0)	.126 (3.2)
16S	1.091 (27.7)	1.260 (32.0)	.126 (3.2)	.969 (24.6)	1.280 (32.5)	.126 (3.2)	1.488 (37.7)	.717 (18.2)	1.079 (27.4)	.126 (3.2)	.969 (24.6)	1.280 (32.5)	.126 (3.2)
16	1.469 (37.3)	1.260 (32.0)	.126 (3.2)	.969 (24.6)	1.280 (32.5)	.126 (3.2)	2.049 (52.0)	.846 (21.5)	1.079 (27.4)	.126 (3.2)	.969 (24.6)	1.280 (32.5)	.126 (3.2)
18	1.500 (38.1)	1.437 (36.5)	.157 (4.0)	1.063 (27.0)	1.378 (35.0)	.126 (3.2)	2.049 (52.0)	.907 (23.0)	1.213 (30.8)	.157 (4.0)	1.063 (27.0)	1.378 (35.0)	.126 (3.2)
20	1.500 (38.1)	1.571 (39.9)	.157 (4.0)	1.157 (29.4)	1.496 (38.0)	.126 (3.2)	2.049 (52.0)	.907 (23.0)	1.346 (34.2)	.157 (4.0)	1.157 (29.4)	1.496 (38.0)	.126 (3.2)
22	1.500 (38.1)	1.697 (43.1)	.157 (4.0)	1.252 (31.8)	1.614 (41.0)	.126 (3.2)	2.049 (52.0)	.907 (23.0)	1.472 (37.4)	.157 (4.0)	1.252 (31.8)	1.614 (41.0)	.126 (3.2)
24	1.598 (40.6)	1.835 (46.6)	.157 (4.0)	1.374 (34.9)	1.752 (44.5)	.146 (3.7)	2.049 (52.0)	.907 (23.0)	1.610 (40.9)	.157 (4.0)	1.374 (34.9)	1.752 (44.5)	.146 (3.7)
28	1.626 (41.3)	2.102 (53.4)	.157 (4.0)	1.563 (39.7)	2.000 (50.8)	.146 (3.7)	2.049 (52.0)	.947 (24.0)	1.839 (46.7)	.157 (4.0)	1.563 (39.7)	2.000 (50.8)	.146 (3.7)
32	1.764 (44.8)	2.366 (60.1)	.157 (4.0)	1.752 (44.5)	2.244 (57.0)	.169 (4.3)	2.049 (52.0)	.947 (24.0)	2.102 (53.4)	.157 (4.0)	1.752 (44.5)	2.244 (57.0)	.169 (4.3)
36	1.764 (44.8)	2.610 (66.3)	.157 (4.0)	1.937 (49.2)	2.500 (63.5)	.169 (4.3)	2.049 (52.0)	.947 (24.0)	2.346 (59.6)	.157 (4.0)	1.937 (49.2)	2.500 (63.5)	.169 (4.3)
40	1.764 (44.8)	2.850 (72.4)	.157 (4.0)	2.185 (55.5)	2.752 (69.9)	.169 (4.3)	2.049 (52.0)	.947 (24.0)	2.579 (65.5)	.157 (4.0)	2.185 (55.5)	2.752 (69.9)	.169 (4.3)

All dimensions in inches (millimeters in parenthesis)

STYLE 7, 70 JAM NUT RECEPTACLES

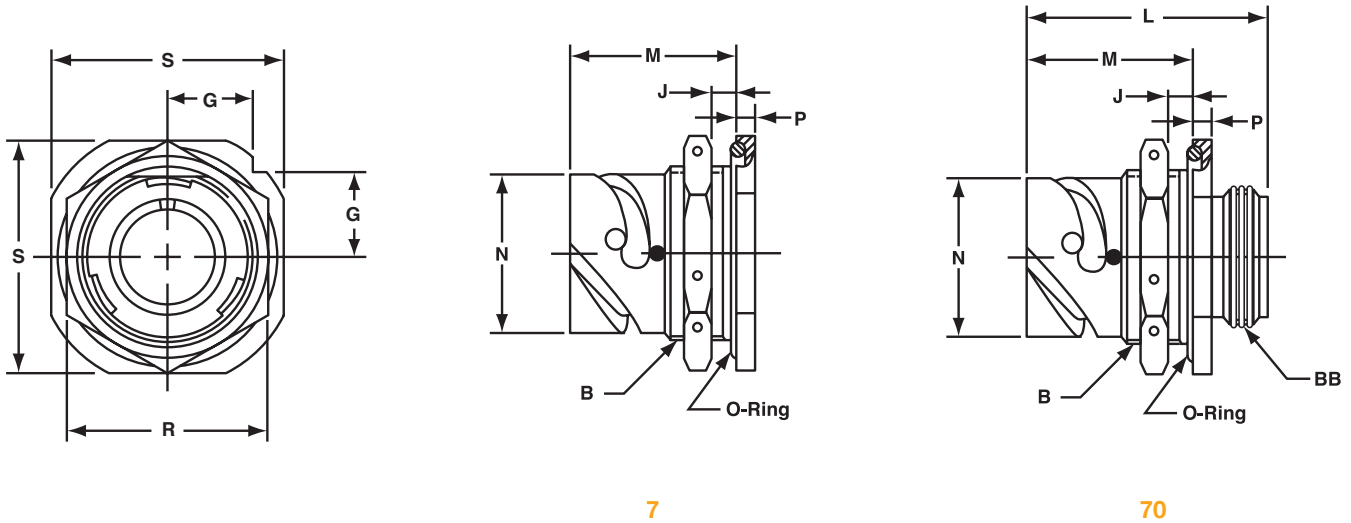

7

70

SHELL SIZE	B THREAD CLASS 2A	G ±.012 (±0.3)	J WALL THICKNESS		L ± .010 (±0.3)	M ± .012 (±0.3)	N +0.000-.1006 (+0.00-0.15)	P ± .007 (±0.2)	R ± .016 (±0.4)	S ± .12 (±0.3)	BB THREAD CLASS 2A
			MIN.	MAX.							
10SL	.8750-20 UNEF	.441 (11.2)	.094 (2.4)	.205 (5.2)	1.425 (36.2)	.965 (24.5)	.717 (18.2)	.157 (4.0)	1.062 (27.0)	1.252 (31.8)	.6250-24 UNEF
14S	1.1250-18 UNEF	.575 (14.6)	.094 (2.4)	.295 (7.5)	1.531 (38.9)	1.055 (26.8)	.969 (24.6)	.189 (4.8)	1.312 (33.3)	1.626 (41.3)	.7500-20 UNEF
16S	1.2500-18 UNEF	.618 (15.7)	.094 (2.4)	.295 (7.5)	1.531 (38.9)	1.055 (26.8)	1.079 (27.4)	.189 (4.8)	1.500 (38.1)	1.748 (44.4)	.8750-20 UNEF
16	1.2500-18 UNEF	.618 (15.7)	.094 (2.4)	.295 (7.5)	1.909 (48.5)	1.264 (32.1)	1.079 (27.4)	.189 (4.8)	1.500 (38.1)	1.748 (44.4)	.8750-20 UNEF
18	1.3750-18 UNEF	.661 (16.8)	.094 (2.4)	.354 (9.0)	1.941 (49.3)	1.327 (33.7)	1.213 (30.8)	.189 (4.8)	1.562 (39.7)	1.874 (47.6)	1.0000-20 UNEF
20	1.5000-18 UNEF	.709 (18.0)	.094 (2.4)	.358 (9.1)	1.941 (49.3)	1.327 (33.7)	1.346 (34.2)	.189 (4.8)	1.750 (44.5)	2.000 (50.8)	1.1250-18 UNEF
22	1.6250-18 UNEF	.795 (20.2)	.094 (2.4)	.358 (9.1)	1.941 (49.3)	1.327 (33.7)	1.472 (37.4)	.189 (4.8)	2.000 (50.8)	2.134 (54.2)	1.2500-18 UNEF
24	1.7500-18 UNEF	.795 (20.2)	.094 (2.4)	.358 (9.1)	1.953 (49.6)	1.327 (33.7)	1.610 (40.9)	.189 (4.8)	2.000 (50.8)	2.252 (57.2)	1.3750-18 UNEF
28	2.0000-18 UNS	.886 (22.5)	.094 (2.4)	.394 (10.0)	2.043 (51.9)	1.386 (35.2)	1.839 (46.7)	.220 (5.6)	2.188 (55.6)	2.500 (63.5)	1.6250-18 UNEF
32	2.2500-16 UN	.972 (24.7)	.094 (2.4)	.394 (10.0)	2.043 (51.9)	1.386 (35.2)	2.102 (53.4)	.220 (5.6)	2.438 (61.9)	2.748 (69.8)	1.8750-16 UN
36	2.5000-16 UN	1.059 (26.9)	.094 (2.4)	.327 (8.3)	2.043 (51.9)	1.386 (35.2)	2.346 (59.6)	.220 (5.6)	2.812 (71.4)	3.000 (76.2)	2.0625-16 UN
40	2.7500-16 UN	1.165 (29.6)	.094 (2.4)	.327 (8.3)	2.043 (51.9)	1.386 (35.2)	2.579 (65.5)	.220 (5.6)	2.953 (75.0)	3.248 (82.5)	2.3125-16 UN

All dimensions in inches (millimeters in parenthesis)

PANEL CUTOUTS

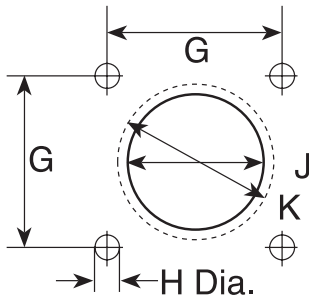

Dim. J-flange in front of panel
 Dim. K-flange at rear of panel
 See sealing screws on [page 439](#).

SHELL SIZE	STYLE 0, 2, 20, 30, TB FLANGE			
	G (TP)	MOUNTING HOLE DIAMETER H	J FRONT	K REAR
10SL	0.717 (18.2)	0.126 (3.2)	0.688 (17.5)	0.750 (19.1)
14S	0.906 (23.0)	0.126 (3.2)	0.813 (20.7)	1.000 (25.4)
16S	0.969 (24.6)	0.126 (3.2)	0.938 (23.8)	1.125 (28.6)
16	0.969 (24.6)	0.126 (3.2)	0.938 (23.8)	1.125 (28.6)
18	1.063 (27.0)	0.126 (3.2)	1.063 (27.0)	1.250 (26.7)
20	1.157 (29.4)	0.126 (3.2)	1.188 (30.2)	1.375 (35.0)
22	1.252 (31.8)	0.126 (3.2)	1.313 (33.4)	1.500 (38.1)
24	1.374 (34.9)	0.146 (3.7)	1.438 (36.5)	1.625 (41.3)
28	1.563 (39.7)	0.146 (3.7)	1.688 (42.9)	1.875 (47.6)
32	1.752 (44.5)	0.169 (4.3)	1.938 (49.2)	2.125 (54.0)
36	1.937 (49.2)	0.169 (4.3)	2.125 (54.0)	2.375 (60.3)
40	2.185 (55.5)	0.169 (4.3)	2.375 (60.3)	2.625 (66.7)

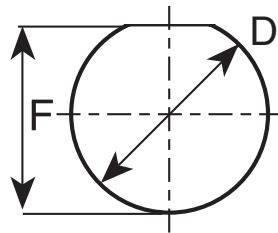

SHELL SIZE	7/70 PANEL CUTOUT	
	F - FLAT	D - DIAMETER
10SL	0.830 (21.1)	0.875 (22.2)
14S	1.080 (27.4)	1.125 (28.6)
16S/16	1.210 (30.7)	1.250 (31.7)
18	1.320 (33.5)	1.375 (34.9)
20	1.450 (36.8)	1.500 (38.1)
22	1.570 (39.9)	1.625 (41.3)
24	1.700 (43.2)	1.750 (44.5)
28	1.950 (49.5)	2.000 (50.8)
32	2.200 (55.9)	2.250 (57.2)
36	2.450 (62.2)	2.500 (63.5)
40	2.700 (68.6)	2.750 (69.9)

PANEL THICKNESS

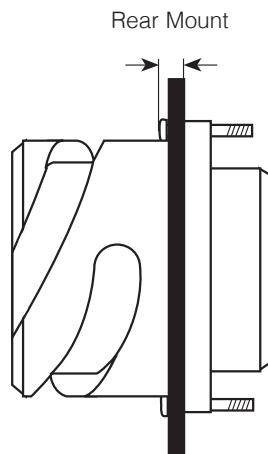

SHELL SIZE	REAR MOUNT
10SL	.303 (7.70)
14S	.303 (7.70)
16S	.303 (7.70)
16	.242 (6.15)
18	.303 (7.70)
20	.303 (7.70)
22	.303 (7.70)
24	.303 (7.70)
28	.343 (8.70)
32	.309 (7.85)
36	.309 (7.85)
40	.309 (7.85)

All dimensions in inches (millimeters in parenthesis)

MS3057-A CABLE CLAMP

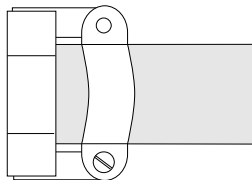

Standard MS3057 cable clamps have dual-clamping action to provide a balanced, positive hold on the wires and greatly reduce moisture transmission. This cable clamp accepts MS3420 bushings. MS3420 bushings can be nested to reduce the inside diameter to more closely match the diameter of the cable or wire bundle.

SHELL SIZE	THREAD CLASS 2B	STANDARD CLAMP				STANDARD CLAMP AND TELESCOPIC BUSHING		
		LOW-COST CAST ZINC	ALUMINUM W/ BRASS SCREWS	ALUMINUM W/ STAINLESS STEEL SCREWS	MAXIMUM CABLE DIAMETER INCH (MM)	ZINC WITH BUSHING	LOW-COST BUSHING INCLUDED	BUSHING ID INCH (MM)
10SL	5/8-24UNEF	97-3057-1004**	MS3057-4A	M85049/41-4A	0.312 (7.92)	97-3057-1004-1	MS3420-4	0.220 (5.6)
14S	3/4-20UNEF	97-3057-1007**	MS3057-6A	M85049/41-6A	0.438 (11.10)	97-3057-1007-1	MS3420-6	0.312 (7.9)
16/16S	7/8-20UNEF	97-3057-1008**	MS3057-8A	M85049/41-8A	0.562 (14.27)	97-3057-1008-1	MS3420-8	0.437 (11.1)
18	1-20UNEF	97-3057-1010**	MS3057-10A	M85049/41-10A	0.625 (15.88)	97-3057-1010-1	MS3420-10	0.562 (14.3)
20/22	1 3/16-18UNEF	97-3057-1012**	MS3057-12A	M85049/41-12A	0.750 (19.05)	97-3057-1012-1	MS3420-12	0.625 (15.9)
24/28	1 7/16-18UNEF	97-3057-1016**	MS3057-16A	M85049/41-16A	0.938 (23.80)	97-3057-1016-1	MS3420-16, -12	0.625 (15.9)
32	1 3/4-18UNS	97-3057-1020**	MS3057-20A	M85049/41-20A	1.250 (31.75)	97-3057-1020-1	MS3420-20, -16	0.750 (19.1)
36	2-18UNS	97-3057-1024**	MS3057-24A	M85049/41-24A	1.375 (34.92)	97-3057-1024-1	MS3420-24, -20	0.937 (23.8)
40	2 1/4-16UNS	-	MS3057-28A	M85049/41-28A	1.625 (41.28)	-	-	-

** Other platings are available. → See page 17 for alternate platings.

MS3057-C WATERPROOF CABLE CLAMP

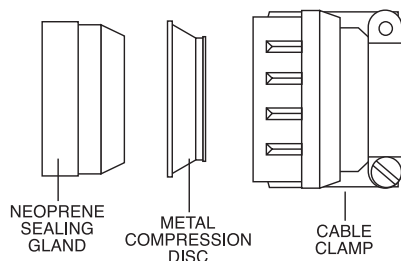

Standard MS3057-C waterproof cable clamp with mechanical strain relief for use with styles F, L and T endbells. Internal neoprene gland and compression ring will seal a broad range of round cable diameters as listed below. For reduction of cable diameters, order the appropriate MS3420A bushing in table.

SHELL SIZE	PART NUMBER	WIRE DIAMETER INCHES (MM)		OPTIONAL BUSHINGS	
		MAX.	MIN.	PART NUMBER	MAX. WIRE DIA. (MM)
10SL	MS3057-4C	0.312 (7.93)	0.188 (4.80)	MS3420-4A	0.219 (5.56)
14S	MS3057-6C	0.438 (11.12)	0.281 (7.10)	MS3420-6A	0.312 (7.93)
16/16S	MS3057-8C	0.530 (13.48)	0.312 (7.90)	MS3420-4A	0.219 (5.56)
				MS3420-8A	0.438 (11.10)
				MS3420-6A	0.312 (7.93)
18	MS3057-10C	0.625 (15.87)	0.375 (9.50)	MS3420-10A	0.438 (11.10)
				MS3420-6A	0.312 (7.93)
20/22	MS3057-12C	0.750 (19.00)	0.500 (12.70)	MS3420-12A	0.540 (13.74)
				MS3420-8A	0.438 (11.10)
24/28	MS3057-16C	0.940 (23.8)	0.625 (15.90)	MS3420-16A	0.750 (19.00)
				MS3420-12A	0.540 (13.74)
				MS3420-8A	0.438 (11.10)
32	MS3057-20C	1.25 (31.75)	0.921 (23.40)	MS3420-20A	0.938 (23.80)
				MS3420-16A	0.750 (19.00)
				MS3420-12A	0.540 (13.74)
36	MS3057-24C	1.38 (35.00)	1.00 (25.40)	MS3420-24A	1.12 (28.5)
				MS3420-18A	0.938 (23.80)
				MS3420-16A	0.750 (19.00)
40	MS3057-28C	1.62 (41.25)	1.25 (31.80)	MS3420-28A	1.25 (31.75)
				MS3420-20A	0.940 (23.80)
				MS3420-16A	0.750 (19.00)

All dimensions in inches (millimeters in parenthesis)

MS3420 TELESCOPING BUSHINGS

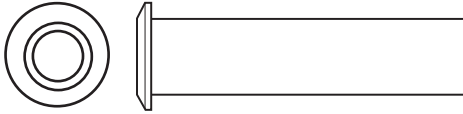

For use with style-A cable clamps and AIT/MS style-E/F endbells to resist dust, dirt and oil. Bushings can be nested, one inside the other, to reduce the inside diameter and form a better seal against the cable jacket. Each bushing will accept the next smallest bushing.

SIZE	1ST BUSHING PART NUMBER	INSIDE DIAMETER	2ND NESTED BUSHING	INSIDE DIAMETER	FITS IN CABLE CLAMP
10SL	MS3420-4	.220 (5.59)	NONE	-	MS3057-4A
14S	MS3420-6	.312 (7.92)	NONE	-	MS3057-6A
16S	MS3420-8	.437 (11.10)	NONE	-	MS3057-8A
16	MS3420-8	.437 (11.10)	NONE	-	MS3057-8A
18	MS3420-10	.562 (14.30)	NONE	-	MS3057-10A
20	MS3420-12	.625 (15.90)	NONE	-	MS3057-12A
22	MS3420-12	.625 (15.90)	NONE	-	MS3057-12A
24	MS3420-16	.750 (19.05)	MS3420-12	.625 (15.90)	MS3057-16A
28	MS3420-16	.750 (19.05)	MS3420-12	.625 (15.90)	MS3057-16A
32	MS3420-20	.937 (23.80)	MS3420-16	.750 (19.05)	MS3057-20A
36	MS3420-24	1.250 (31.75)	MS3420-20	.937 (23.80)	MS3057-24A
40	MS3420-28	1.375 (34.92)	MS3420-24	1.250 (31.75)	SE96-28A4

MS3420-A REDUCTION BUSHINGS



For use with MS3057-C cable clamps (style-C) to reduce the wire sealing diameter. Bushings can be nested, one inside the other, to progressively reduce the inside diameter of the cable clamp. The column labeled “reduction bushings” shows the acceptable nesting options for each clamp.



9767 CABLE CLAMPS

9767 waterproof cable clamp with mechanical strain relief. An internal neoprene gland seal bushing and compression washer will seal a broad range of round cable diameters, as listed below.

SHELL SIZE	CABLE CLAMP PART NUMBER	MAX. CABLE OD		MIN. CABLE OD		THREAD CLASS 2B
		INCHES	(mm)	INCHES	(mm)	
10SL	9767-12-4	0.219	(5.55)	0.020	(0.51)	5/8-24 UNEF
14S	9767-14-4	0.219	(5.55)	0.020	(0.51)	3/4-20 UNEF
14S	9767-14-6	0.344	(8.73)	0.176	(4.47)	3/4-20 UNEF
16S/16	9767-16-4	0.219	(5.55)	0.020	(0.51)	7/8-20 UNEF
16S/16	9767-16-6	0.344	(8.73)	0.176	(4.47)	7/8-20 UNEF
16S/16	9767-16-8	0.438	(11.12)	0.177	(4.50)	7/8-20 UNEF
18	9767-18-6	0.344	(8.73)	0.176	(4.47)	1-20 UNEF
18	9767-18-8	0.438	(11.12)	0.177	(4.50)	1-20 UNEF
18	9767-18-10	0.563	(14.29)	0.292	(7.42)	1-20 UNEF
20/22	9767-22-8	0.438	(11.12)	0.177	(4.50)	1-3/16-18 UNEF
20/22	9767-22-10	0.563	(14.29)	0.292	(7.42)	1-3/16-18 UNEF
20/22	9767-22-12	0.688	(17.46)	0.370	(9.40)	1-3/16-18 UNEF
24/28	9767-28-10	0.563	(14.29)	0.292	(7.42)	1-7/16-18 UNEF
24/28	9767-28-12	0.688	(17.46)	0.370	(9.40)	1-7/16-18 UNEF
24/28	9767-28-16	0.844	(21.43)	0.536	(13.61)	1-7/16-18 UNEF
32	9767-32-20	1.031	(26.19)	0.590	(14.99)	1-3/4-18 UNS
36	9767-36-16	0.844	(21.43)	0.536	(13.61)	2-18 UNS

All dimensions in inches (millimeters in parenthesis)

GASKETS

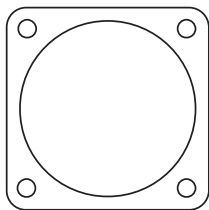



Synthetic rubber gaskets are used to ensure a moisture-tight seal between a receptacle and the panel. Gaskets are available for front or rear-panel mounting of styles 0, 2, 20, 30 and TB connectors. Gasket thickness is approximately .031 inches (1 mm), for nonconductive and low-temperature types.

Conductive shielding gaskets contain an embedded metal screen for EMI/RFI shielding in addition to moisture sealing. Gaskets are available for front or rear-panel mounting of styles 30 and TB connectors. Gasket thickness is .020 inches (.5 mm).

SHELL SIZE	FRONT MOUNT			REAR MOUNT
	NON-CONDUCTIVE	CONDUCTIVE	LOW-TEMPERATURE	NON-CONDUCTIVE
10SL	10-040450-010	10-040450-10S	10-036675-010	10-580649-011
14S	10-040450-014	10-040450-14S	10-036675-014	10-580649-014
16S	10-040450-016	10-040450-16S	10-036675-016	10-580649-016
16	10-040450-016	10-040450-16S	10-036675-016	10-580649-016
18	10-040450-018	10-040450-18S	10-036675-018	10-580649-018
20	10-040450-020	10-040450-20S	10-036675-020	10-580649-020
22	10-040450-022	10-040450-22S	10-036675-022	10-580649-022
24	10-040450-024	10-040450-24S	10-036675-024	10-580649-024
28	10-040450-028	10-040450-28S	10-036675-028	10-580649-028
32	10-040450-032	10-040450-32S	10-036675-032	10-580649-032
36	10-040450-036	10-040450-36S	10-036675-036	10-580649-036
40	10-040450-040	10-040450-40S	10-036675-040	10-580649-040

METAL DUST CAPS WITH SASH CHAIN

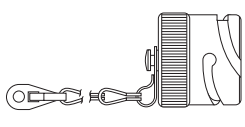
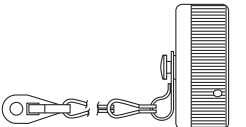
Metal dust caps are used to protect the contacts when the connectors are left unmated. Dust caps come with metal chain lanyards. Dummy Receptacles are for front or rear-panel mounting. AIB/GT Series connectors have bayonet ramps. The center of the connector is closed. Dummy receptacles mount on the same centers and have the same outside dimensions as a STYLE 2 receptacle. A version with a clearance hole through the middle of the connector is also available. Contact us for ordering information.

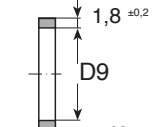
SHELL SIZE	DUST CAPS			
	PLUG CAP	RECEPTACLE	DUMMY RECEPTACLES	PLUG SEAL RING
				
10SL	10-580903-11*	10-580902-11*	10-580595-11*	10-564843-101
14S	10-580903-14*	10-580902-14*	10-580595-14*	10-564843-141
16S	10-580903-16*	10-580902-16*	10-580595-16*	10-564843-161
16	10-580903-17*	10-580902-17*	10-580595-17*	10-564843-161
18	10-580903-18*	10-580902-18*	10-580595-18*	10-564843-181
20	10-580903-20*	10-580902-20*	10-580595-20*	10-564843-201
22	10-580903-22*	10-580902-22*	10-580595-22*	10-564843-221
24	10-580903-24*	10-580902-24*	10-580595-24*	10-564843-241
28	10-580903-28*	10-580902-28*	10-580595-28*	10-564843-281
32	10-580903-32*	10-580902-32*	10-580595-32*	10-564843-321
36	10-580903-36*	10-580902-36*	10-580595-36*	10-564843-161
40	10-580903-40*	10-580902-40*	10-580595-40*	10-564843-401

*Select code for plating:

Z = Black anodize

3 = Olive drab cadmium plate

9 = Olive drab cadmium nickel base

G = Electroless nickel

U = Green zinc

Y = Black alloy

SOLDER CONTACTS

STEP 1: Slide the rear accessories over the wire bundle in the proper sequence for re-assembly: cable clamp and/or endbell first, then ferrule and (if used) coupling nut.

STEP 2: Insert individual wires through the proper holes in the grommet. Use isopropyl alcohol as a lubricant.

STEP 3: Solder wires to appropriate contacts on the rear of the connector. Information on standard soldering practices is available upon request. Please contact us.

STEP 4: Fixture the connector for reassembly using the endbell assembly tools on [page 122](#)

STEP 5: Slide the grommet down the wires (lubricating the grommet with isopropyl alcohol will help).

STEP 6: Fill all unused grommet cavities with a wire hole filler to maintain the sealing integrity of the connector.

STEP 7: Slide coupling nut, ferrule, and endbell accessories over rear of the connector and tighten. For tooling, [see page 122](#).

CRIMP TOOL OPERATION

NOTE: Hand-crimp tools can be used with size 16S, 16 & 12 contacts. Size 8, 4 and 0 contacts require the use of air-powered crimp tools. Contact us for assistance in the use of these tools.

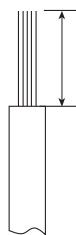

STEP 1: Strip the wires to the appropriate length. See strip lengths on the Contact Selection Guide, [see page 94](#).

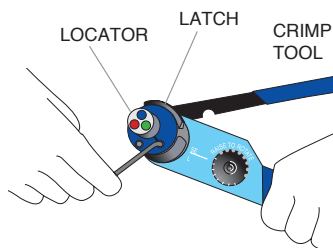

STEP 2: Open the crimp tool by squeezing the handles. Push the latch on the turret to pop up the locator. Attach the turret to the crimp tool using the two captive hex bolts in the turret.

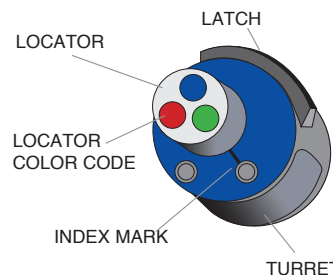

STEP 3: Select the proper locator position for your contact by rotating the locator until the proper color is aligned with the index mark. Push locator back down until it snaps into position.

CONTACT SIZE	PIN LOCATOR COLOR	SOCKET LOCATOR COLOR
16S	Red	Red
16	Blue	Green
12	Green	Green

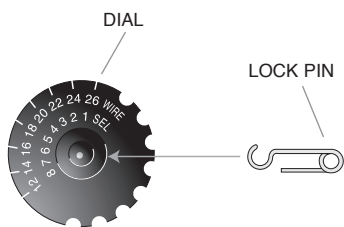

STEP 4: Adjust dial for proper wire gauge. To change the dial setting, remove the lock pin and lift center of dial. Turn to the desired wire gauge. Replace lock pin on dial.

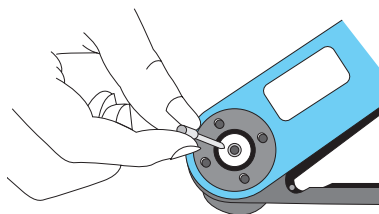

STEP 5: Cycle the tool before inserting the contact to be sure the tool is in the open position. Drop the contact, mating end first, into the crimp cavity of the tool. Squeeze the tool handle just enough to grip the contact without actually crimping it.

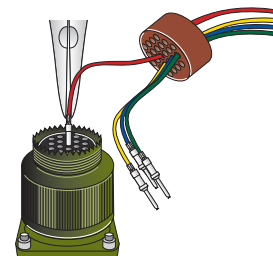

STEP 6: Insert the stripped wire into the contact with a slight twisting motion. Be sure all wire strands are inside the contact. Squeeze the handle to cycle the tool. The handle will not release until the contact is completely crimped.

CRIMP TOOL OPERATION (CONTINUED)

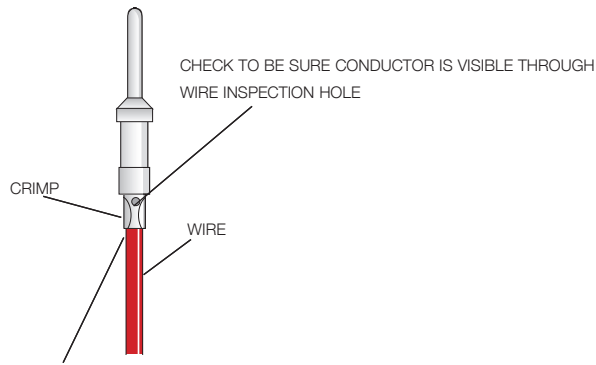

STEP 7: Remove the crimped contact. Pull on the wire slightly to be sure it is properly crimped. Be sure the contact is not bent or damaged in any way. Visually inspect the crimp.

MICRO-SECTIONS: Enlargement of micro-section permits a final inspection of crimp quality. This test is recommended whenever new tools or new types of wire or contacts are used.

CRIMP TENSILE STRENGTH

Initial minimum pullout force in lbs. (before conditioning)

SIZE	WIRE GAUGE	LB.
16	20	20
	18	40
	16	50
12	14	70
	12	110
8	8	185
4	4	450
0	0	800

INSERTION OF CONTACTS

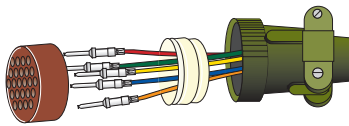

STEP 1: Slide the rear accessories over the wire bundle in the proper sequence for re-assembly: cable clamp and/or endbell first, then ferrule, and coupling nut.

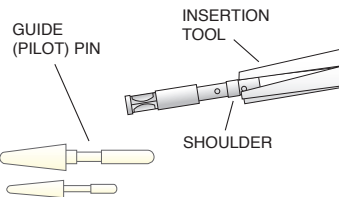

STEP 2: Use the proper insertion tool from the Contact Selection Chart on [page 94](#). Place the contact in the tool. The tool should press against the shoulder of the contact. Contact sizes 16S, 16, and 12 use a pliers-style tool. Contact sizes 8, 4 and 0 use a tool with a C-shaped shaft.

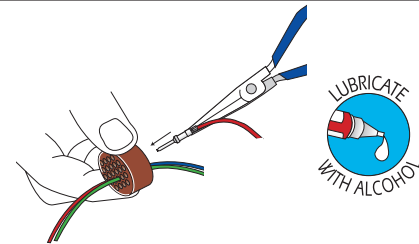

STEP 3: Lubricate the grommet with isopropyl alcohol (do not use any lubricant other than isopropyl alcohol). Insert the contact through the appropriate cavity in the grommet. Sizes 16S, 16 and 12 socket contacts must be installed using guide (pilot) pins. See the Contact Selection Guide on [page 94](#) for Insertion Guide (Pilot) Pin part numbers.

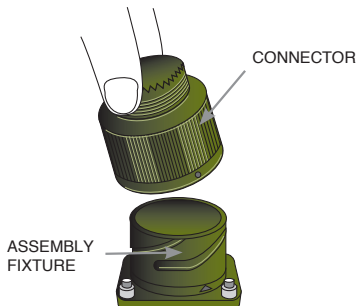

STEP 4: Place the connector into an assembly fixture (fixtures are available for production use, contact us.) If you are not using a fixture, be sure to allow clearance on the mating face of the connector for the guide pins to come through the connector during insertion.



STEP 5: Lubricate the contact cavities of the connector insulator with isopropyl alcohol (do not use any other type of lubricant).

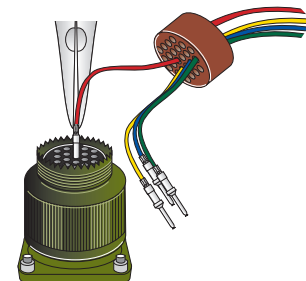

STEP 6: Using guide pins where necessary, push straight down with a firm even pressure until the contact snaps into position in the proper cavity. Start at the center of the pattern and work toward the outer edges.

INSERTION OF CONTACTS (CONTINUED)

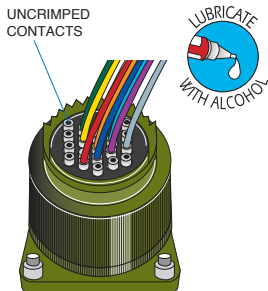

STEP 7: Fill any unused cavities with contacts.

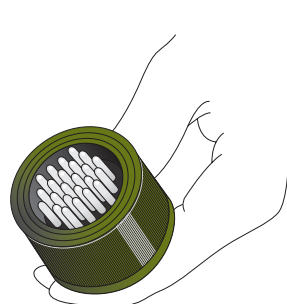

STEP 8: Check the mating face of the connector to ensure that all the same size contacts are on the same plane (fully inserted). If not, the contact is not fully inserted. Remove the contact using the proper extraction tool and procedure and reinsert. Do not attempt to reinsert the insertion tool to correct the problem.

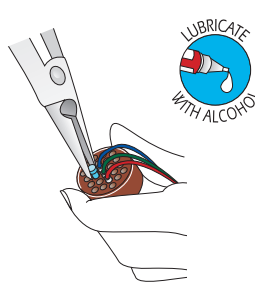

STEP 9: A wire hole filler must be inserted into the grommet behind the unused contacts to maintain the sealing integrity of the connector. See the Contact Selection Chart on [page 94](#) for wire hole fillers.

STEP 10: Place the connector back in the fixture for re-assembly. Slide the connector accessories back down the cable over the rear of the connector and tighten. Use the appropriate endbell tools as shown on [page 122](#).

EXTRACTION OF CONTACTS

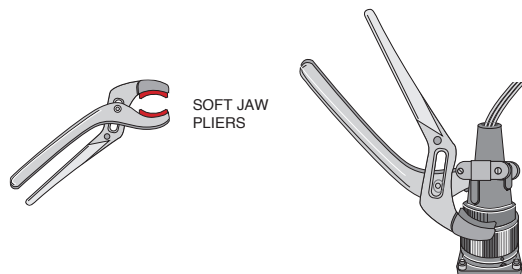

STEP 1: Remove the endbell accessories and slide them back over the wires. Use the appropriate endbell tools as shown on [page 122](#).

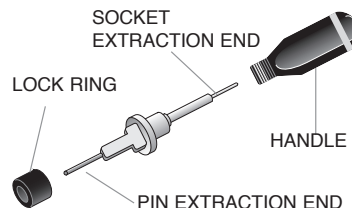

STEP 2: Use the proper extraction tool from the Contact Selection Chart on [page 94](#). The extraction tool can be used for both pin and socket contacts by removing the shaft from the handle and reversing it for pin or socket extraction.

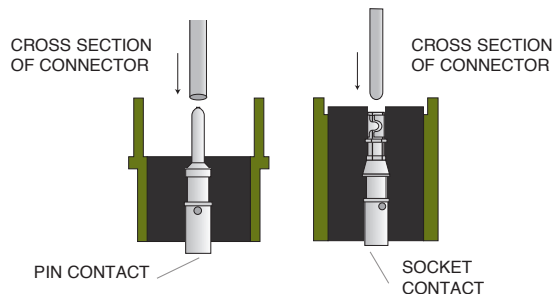

STEP 3: On the mating face of the connector, insert the tool over the pin contact or into the socket contact until the tool bottoms. Apply a slow continuous pressure to push the contact out the rear of the connector. When the shoulder of the tool “thunks” against the insulator, the contact is extracted.

STEP 4: Carefully remove the extraction tool from the connector to avoid damage to the insulator.

AIB/GT SERIES CONNECTORS

GT C 00 A 36-5 P W- (002)

SERIES

GT Circular connectors with bayonet coupling

CONTACT STYLE/INSERT

C = Crimp
S = Solder
CY = Crimp with Viton®
SY = Solder with Viton®
CL = Crimp with low-smoke/flame-retardant inserts
SL = Solder with low-smoke/flame-retardant inserts

SHELL STYLE

00 Wall-mount receptacle
01 Inline receptacle
02 Box-mount receptacle
020 Box-mount receptacle with accessory threads
030 Square flange receptacle - rear panel mount
(most popular)
05 Dummy receptacle
06 Straight plug (most popular)
062 Straight plug with deep-serrated coupling nut
064 Panel-mounted plug with heavy-duty coupling nut
065 Straight plug with long heavy-duty coupling nut
07 Jam nut receptacle - rear panel mount
070 Jam nut receptacle with accessory threads
08 90° angle plug
TB Thru-bulkhead

MATEABILITY WITH IDENTICAL CONTACT ARRANGEMENTS

CONNECTOR STYLE	MATEABLE WITH STYLE
GT00	GT06/062/064/065/08
GT01	GT06/062/064/065/08
GT02	GT06/062/064/065/08
GT020	GT06/062/064/065/08
GT030	GT06/062/064/065/08
GT06/062/064/065	GT00/01/02/020/03/030/05/070/TB
GT07/070	GT06/062/064/065/08
GT08	GT00/01/02/020/03/030/05/070/TB
GTTB	GT06/062/064/065/08

*Viton® is a registered trademark of DuPont DOW Elastomers

CONNECTOR SHELL VARIATIONS

Omit for standard olive drab with silver plated contacts
G96 Black anodized
014 Olive drab cadmium plate, nickel base
A24 Gold/nickel-plated contacts
023 Electroless nickel (RoHS with crimp only)
025 Black alloy (RoHS with crimp only)
027 Conductive black alloy (RoHS with crimp only)
024 Green zinc
B30 Gold
RDS Radsok power contacts 8, 4 & 0 socket contact only
116 Less pre-tinned solder cups
472 116 & 025 mod codes (RoHS)
548 116 & 023 mod codes (RoHS)
553 116 & 027 mod codes (RoHS)

ALTERNATE INSERT ROTATION

W, X, Y, and Z designate that the insert is rotated in its shell from a normal position. No letter required for normal (no rotation) position.

See → pages 83-93.

CONTACT STYLE

P pin contacts
S socket contacts

SHELL SIZE & LAYOUT

See → pages 72-82.

CONNECTOR CLASS

A General-duty, threaded backshell, no cable clamp, no grommet
AF General-duty, threaded backshell, cable clamp, no grommet
F General-duty, threaded backshell, cable clamp, with grommet
CF General-duty, threaded endbell, gland-seal cable clamp, no grommet
CFZ General-duty, threaded endbell, gland-seal cable clamp, with grommet
G One-piece, heat shrink endbell adaptor, with grommet (use with heat shrink boot – see Accessories).
→ pages 440-441
G2 Two-piece, heat shrink endbell adaptor, with grommet (use with heat shrink boot – see Accessories).
→ pages 440-441
LC Long-threaded backshell, gland-seal cable clamp, with grommet, and basket-weave cord grip (please call with cable O.D.)
LCF Long-threaded endbell, gland-seal cable clamp, no grommet
LCFZ Long-threaded endbell, gland-seal cable clamp, with grommet
R General-duty, threaded backshell, no cable clamp, with grommet
RV General-duty, short backshell, with grommet (may be used with heat shrink boot – see Accessories).
→ pages 440-441
CFGG General-duty, threaded endbell, gland-seal cable clamp, no grommet, rubber-covered coupling nut (shell styles 06 and 08 only)
PP Panel plug, only for shell styles 06 and 064
LT Long back shell for metal core conduit, with grommet (please call with conduit O.D.)
PFC For plastic, flexible conduit (please call with conduit O.D.) → see pages 445
SL Long backshell for use with PG gland-seal style cord grip (please call with cable O.D.)

AIBC/ACA-B SERIES CONNECTORS

To more easily illustrate ordering procedure, part number ACA3106E181SXB-F80 is shown as follows:

ACA 3106 E 18 1 S X B - F80

SERIES

ACA Circular Connector Family

SHELL STYLES

- 3100 - Wall-mount receptacle with rear accessory threads for front mounting through holes in flange
- 3101 - Cable-connecting receptacle with rear accessory threads
- 3102 - Front-mount box receptacle no rear accessory threads through holes in flange
- 3103 - Rear-mount box receptacle with rear accessory threads through holes in flange
- 3106 - Plug straight
- 3107A - Jam nut receptacle rear mount, no rear accessory threads
- 3108 - Plug with 90 degree endbell

CONNECTOR CLASS

- E Environmental with resilient insulator and endbell with clamp and bushing
- F Environmental with resilient insulator and endbell with rear accessory threads
- G Two-piece backshell for heat shrink boots
- R Environmental with resilient insulator and shortened lightweight endbell without cable clamp

SHELL SIZE

10SL, 14S, 16S, 16, 18, 20, 22, 24, 28, 32, and 36

CONNECTOR MODIFICATION

- 01 - Metric crimp contacts
 - 116 - Less solder filled contacts
 - F80 - AWG crimp contacts
 - A176- Gold-plated contacts
 - A23 - Electroless nickel plating shells
 - A232- Black zinc cobalt-plated shells
 - F42 - Less grommet, endbell & sleeve (*ferrule*)
 - F0 - Less contacts (*ordered separately*)
 - RFI - Grounding spring on barrel (*3106 & 3108*)
 - T00 - Metric threaded holes in flange (*3100, 3102, 3103 only*)
- Contact us for other modifications

REVERSE BAYONET COUPLING

ALTERNATE ROTATION

W, X, Y, and Z
 No suffix required for normal position
 ⇨ See pages 83-93 for valid alternate insert position (*rotation*)

CONTACTTYPE

- P - Pin
- S - Socket

CONNECTOR ARRANGEMENT

⇨ See pages 72-82 for layouts by number of contacts

MATEABILITY WITH IDENTICAL CONTACT ARRANGEMENTS

CONNECTOR STYLE	MATEABLE WITH STYLE
ACA 3100	ACA3106/ ACA3108
ACA 3101	ACA3106/ ACA3108
ACA 3102	ACA3106/ ACA3108
ACA 3103	ACA3106/ ACA3108
ACA 3105	ACA3106/ ACA3108
ACA 3106	ACA3101/ ACA3102/ ACA3103
ACA 3108	ACA3101/ ACA3102/ ACA3103

Use the AIB/GT Series part numbering system on ⇨ pages 70-71 whenever possible.

VG95234 NATO SPECIFICATIONS

VG95234- A 20-29 P 1 N

VG SPEC PREFIX _____

SHELLSTYLE _____

See chart below

SHELL SIZE - LAYOUT _____

⇒ See pages 72-82.

CONTACT STYLE _____

P = Pin contacts
S = Socket contacts

TERMINATION _____

1 = AWG crimp
Blank = metric crimp

POLARIZATION _____

⇒ See pages 83-93.

SHELLSTYLE

Mates with	PLUGS
	<ul style="list-style-type: none"> D Straight plug with cable clamp E Right angle plug with cable clamp E1 Right angle plug for conduit termination G Straight plug with heat shrink endbell H Straight plug for conduit termination K Right angle plug for conduit termination with grounding fingers L Straight plug for conduit termination with grounding fingers M Straight plug with shielded heat shrink endbell and grounding fingers R1 Straight plug with shielded heat shrink endbell and grounding fingers T Straight plug with heat shrink endbell and grounding fingers
	RECEPTACLES
	<ul style="list-style-type: none"> A Front panel mount box receptacle B1 Rear panel mount box receptacle, metric mounting holes B2 Rear panel mount box receptacle, through mounting holes F In-line receptacle with cable clamp J1 Rear panel mount wall receptacle with cable clamp, metric mounting holes J2 Rear panel mount wall receptacle with cable clamp, through mounting holes N1 Rear panel mount wall receptacle with shielded heat shrink endbell, metric mounting holes N2 Rear panel mount wall receptacle with shielded heat shrink endbell, through mounting holes S1 Rear panel mount wall receptacle with heat shrink endbell, metric mounting holes S2 Rear panel mount wall receptacle with heat shrink endbell, through mounting holes U1 Rear panel mount wall receptacle with heat shrink endbell, metric mounting holes U2 Rear panel mount wall receptacle with heat shrink endbell, through mounting holes V In-Line receptacle with conduit termination

VG95234 SHELL STYLES

<p>VG95234 STYLE A</p>	<p>VG95234 STYLE B1/B2</p>	<p>VG95234 STYLE D</p>	<p>VG95234 STYLE E</p>
			
<p>VG95234 STYLE F</p>	<p>VG95234 STYLE G</p>	<p>VG95234 STYLE H</p>	<p>VG95234 STYLE J1/J2</p>
			
<p>VG95234 STYLE K</p>	<p>VG95234 STYLE L</p>	<p>VG95234 STYLE M</p>	<p>VG95234 STYLE N1/N2</p>
			
<p>VG95234 STYLE R1</p>	<p>VG95234 STYLE S1/S2</p>	<p>VG95234 STYLE T</p>	<p>VG95234 STYLE U1/U2</p>
			

TG70 STRAP WRENCH

The strap wrench is used to connect or disconnect coupling nuts in a confined space, or to tighten or loosen endbells without damaging the connector plating. A strap wrench also increases torque, allowing you to more easily mate or unmate a connector pair. Substitute tools, such as a pipe wrench or pliers, should never be used because of the high probability of severe damage to the connector plating or the coupling mechanism.



TG69P NON-MARRING ADJUSTABLE ENDBELL PLIERS FOR FIELD SERVICE

The TG69P pliers have resilient jaws and are used to tighten or remove endbells without damaging the connector plating. The pliers are adjustable and will accommodate all of the connector sizes in this catalog. Substitute tools, such as a pipe wrench or metal jaw pliers, should never be used due to the high probability of severe damage to the connector plating. Replacement jaws, Part No. G77015, are available.



The 600 Series is a complete system for the proper assembly and torquing of connector endbells. The system includes a bench-mounted or hand-held torque wrench, plug and receptacle holders, and a range of endbell tightening tools. When used together, these tools provide the user with consistent endbell installations. Each item is shipped with detailed assembly instructions.

Plug and Receptacle Holders

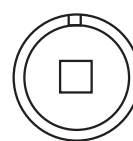

600B005-R

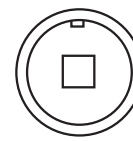

600B005-P



600-007
Bench-mounted
torque wrench



600-004
Hand-held
torque wrench

SIZE	MIL-DTL-5015	
	FOR AIT/MS & AIB/GT	
	RECEPTACLES	PLUGS
8/8S	600B005-8R	600B005-8P
10S/SL	600B005-10R	600B005-10P
12/12S	600B005-12R	600B005-12P
14/14S	600B005-14R	600B005-14P
16/16S	600B005-16R	600B005-16P
18	600B005-18R	600B005-18P
20	600B005-20R	600B005-20P
22	600B005-22R	600B005-22P
24	600B005-24R	600B005-24P
28	600B005-28R	600B005-28P
32	600B005-32R	600B005-32P
36	600B005-36R	600B005-36P

TORQUE VALUES

IMPORTANT NOTE:

If barrel/shell has three threads or less, torque to 30 to 35 inch/Lbs (3.4 to 4.0 NM) per L-725-2.

SIZE	IN./LB. MAX.
10SL	26
14S	44
16	50
16S	50
18	55
20	65
22	85
24	90
28	114
32	120
36	153
40	170

ROTATIONS	
PIN	SOCKET
W = G	W = H
X = I	X = J
Y = K	Y = L
Z = M	Z = N