

Typical Applications

The HMC263 is ideal for:

- Millimeterwave Point-to-Point Radios
- LMDS
- VSAT
- SATCOM

Functional Diagram

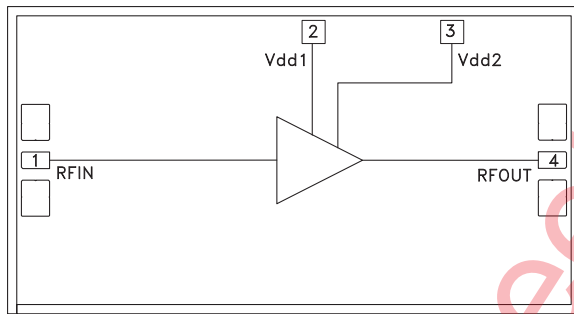

Features

- Excellent Noise Figure: 2 dB
- Gain: 22 dB
- Single Supply: +3V @ 58 mA
- Small Size: 2.48 x 1.33 x 0.1 mm

General Description

The HMC263 chip is a GaAs MMIC Low Noise Amplifier (LNA) which covers the frequency range of 24 to 36 GHz. The chip can easily be integrated into Multi-Chip Modules (MCMs) due to its small (3.29 mm²) size. The chip utilizes a GaAs PHEMT process offering 22 dB gain from a single bias supply of + 3V @ 58 mA with a noise figure of 2.0 dB. All data is with the chip in a 50 ohm test fixture connected via 0.076 mm (3 mil) diameter ribbon bonds of minimal length 0.31 mm (<12 mils). The HMC263 may be used in conjunction with HMC264 or HMC265 mixers to realize a millimeterwave system receiver.

Electrical Specifications, $T_A = +25^\circ C$, $V_{dd} = +3V$

| Parameter | Min. | Typ. | Max. | Min. | Typ. | Max. | Min. | Typ. | Max. | Units |
|---|---------|------|------|---------|------|------|---------|------|------|-------|
| Frequency Range | 24 - 27 | | | 27 - 32 | | | 32 - 36 | | | GHz |
| Gain | 20 | 23 | 26 | 18 | 22 | 26 | 17 | 20 | 23 | dB |
| Gain Variation Over Temperature | | 0.03 | 0.04 | | 0.03 | 0.04 | | 0.03 | 0.04 | dB/°C |
| Noise Figure | | 2.5 | 3.3 | | 2.0 | 2.5 | | 2.1 | 2.6 | dB |
| Input Return Loss | 7 | 10 | | 7 | 10 | | 7 | 10 | | dB |
| Output Return Loss | 7 | 10 | | 9 | 12 | | 8 | 11 | | dB |
| Output Power for 1 dB Compression (P1dB) | -1 | 3 | | 1 | 5 | | 4 | 8 | | dBm |
| Saturated Output Power (P _{sat}) | 1 | 5 | | 3 | 7 | | 6 | 10 | | dBm |
| Output Third Order Intercept (IP3) | 5 | 10 | | 7 | 13 | | 11 | 17 | | dBm |
| Supply Current (I _{dd}) (@ V _{dd} = +3.0V) | | 58 | 77 | | 58 | 77 | | 58 | 77 | mA |

GaAs MMIC LOW NOISE AMPLIFIER, 24 - 36 GHz

Gain vs. Temperature @ Vdd = +3V

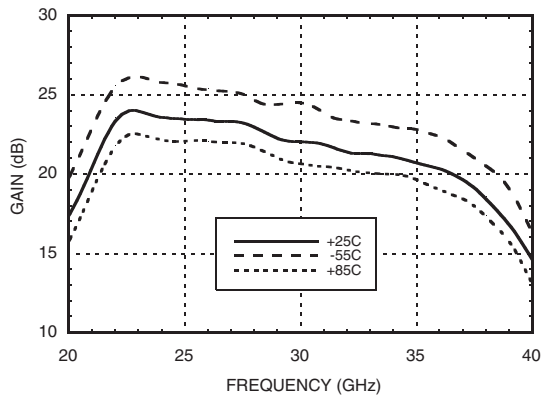

Gain vs. Temperature @ Vdd = +5V

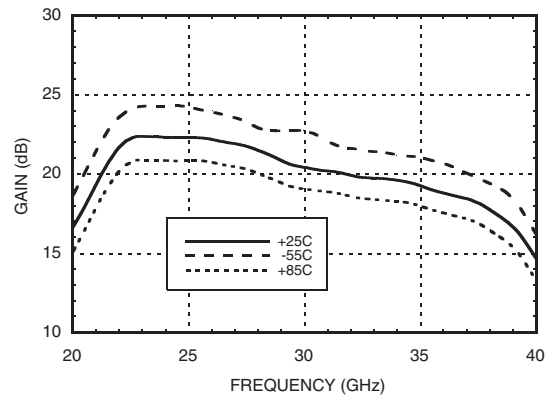

Return Loss @ Vdd = +3V

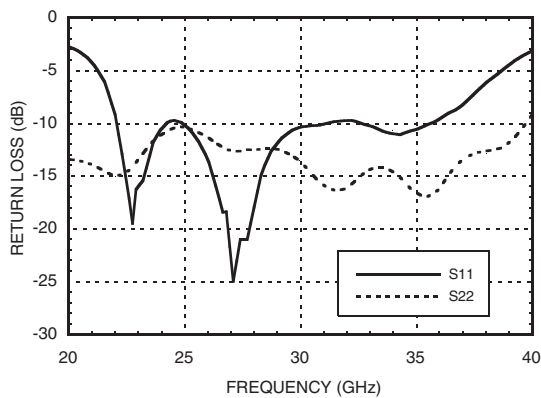

Return Loss @ Vdd = +5V

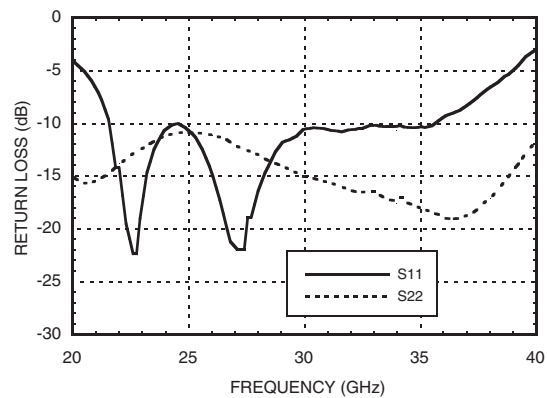

Noise Figure vs. Temperature @ Vdd = +3V

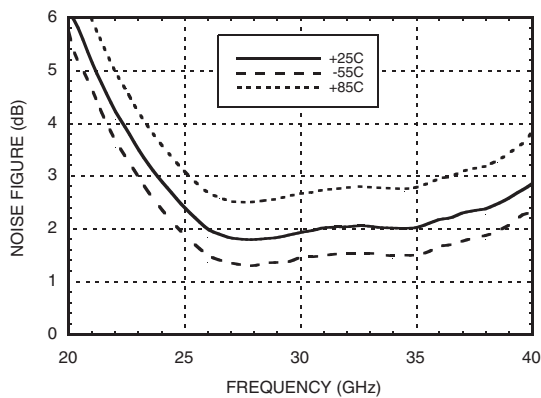

Noise Figure vs. Temperature @ Vdd = +5V

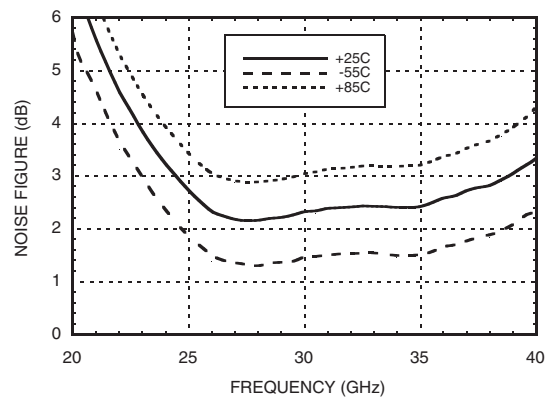

GaAs MMIC LOW NOISE AMPLIFIER, 24 - 36 GHz

1

AMPLIFIERS - LOW NOISE - CHIP

Gain & Noise Figure vs. Supply Voltage @ 30 GHz

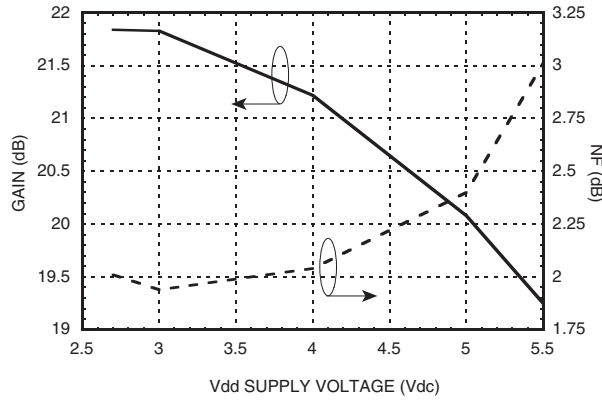

Isolation

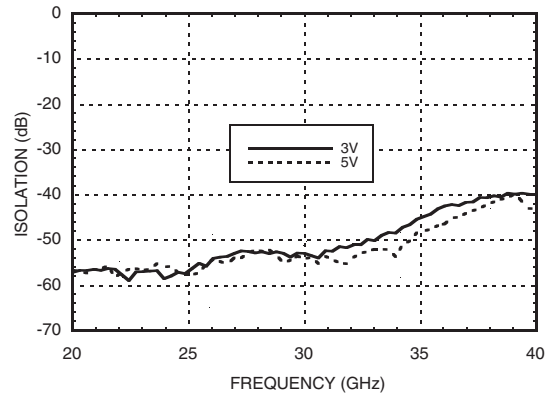

Output P1dB @ Vdd = +3V

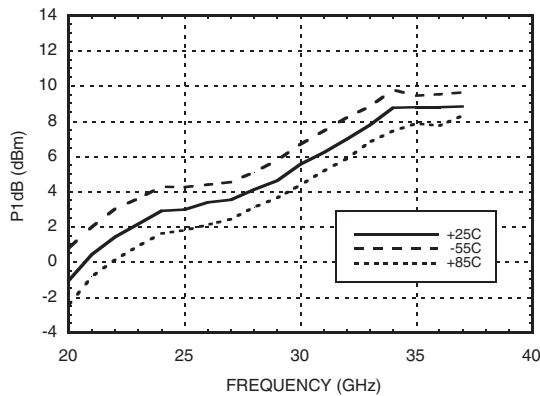

Output P1dB @ Vdd = +5V

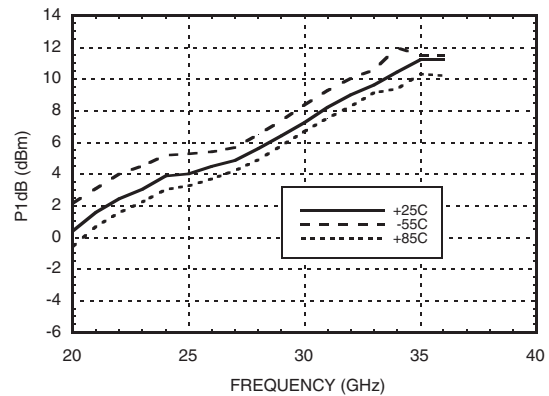

Output IP3 @ Vdd = +3V

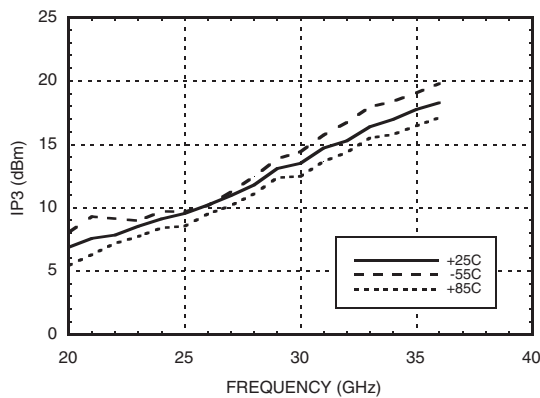

Output IP3 @ Vdd = +5V

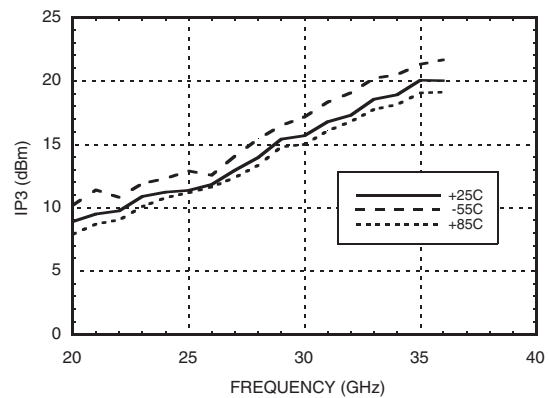

Absolute Maximum Ratings

| | |
|---|----------------|
| Drain Bias Voltage (Vdd1, Vdd2) | +5.5 Vdc |
| RF Input Power (RFIN)(Vdd = +3 Vdc) | -5 dBm |
| Channel Temperature | 175 °C |
| Continuous P _{diss} (T = 85 °C) (derate 7.69 mW/°C above 85 °C) | 0.692 W |
| Thermal Resistance (channel to die bottom) | 130 °C/W |
| Storage Temperature | -65 to +150 °C |
| Operating Temperature | -55 to +85 °C |



ELECTROSTATIC SENSITIVE DEVICE
OBSERVE HANDLING PRECAUTIONS

Outline Drawing

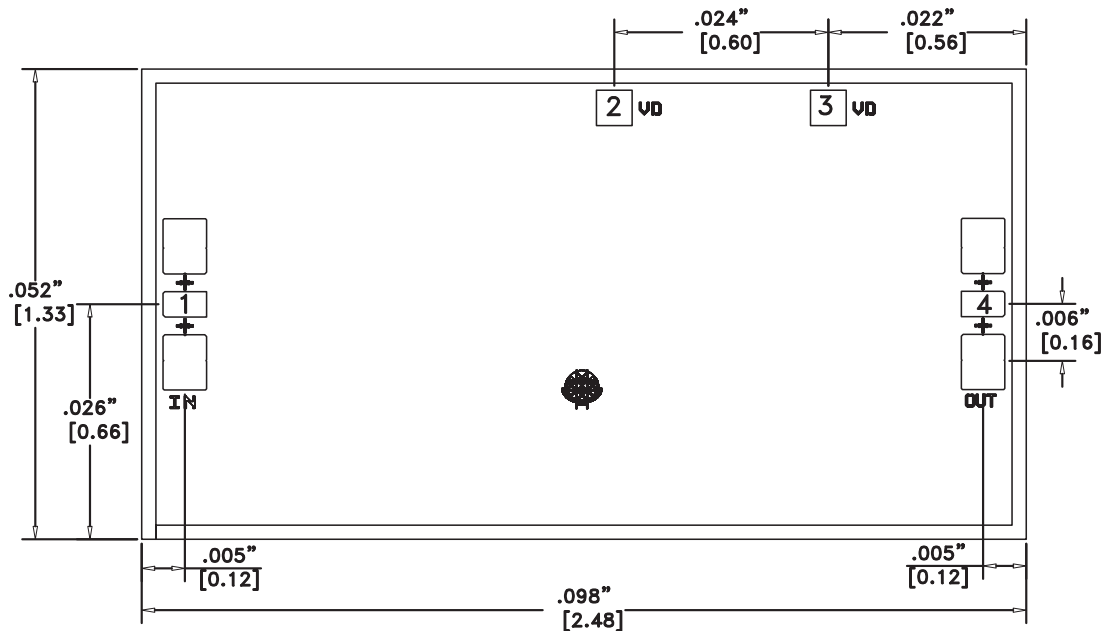

Die Packaging Information [1]

| Standard | Alternate |
|-----------------|-----------|
| GP-2 (Gel Pack) | [2] |

[1] Refer to the "Packaging Information" section for die packaging dimensions.

[2] For alternate packaging information contact Hittite Microwave Corporation.

NOTES:

1. ALL DIMENSIONS IN INCHES (MILLIMETERS)
2. ALL TOLERANCES ARE ±0.001 (0.025)
3. DIE THICKNESS IS 0.004 (0.100) BACKSIDE IS GROUND
4. BOND PADS ARE 0.004 (0.100) SQUARE
5. BOND PAD SPACING, CTR-CTR: 0.006 (0.150)
6. BACKSIDE METALLIZATION: GOLD
7. BOND PAD METALLIZATION: GOLD

Pad Description

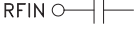
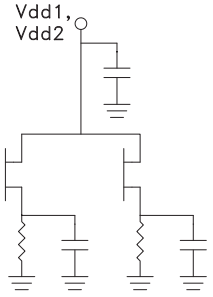
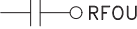
| Pad Number | Function | Description | Interface Schematic |
|------------|------------|---|--|
| 1 | RFIN | This pad is AC coupled and matched to 50 Ohm. | RFIN  |
| 2, 3 | Vdd1, Vdd2 | Power supply for the 4-stage amplifier. An external RF bypass capacitor of 100 - 300 pF is required. The bond length to the capacitor should be as short as possible. The ground side of the capacitor should be connected to the housing ground. |  |
| 4 | RFOUT | This pad is AC coupled and matched to 50 Ohm. |  |

Assembly Diagrams

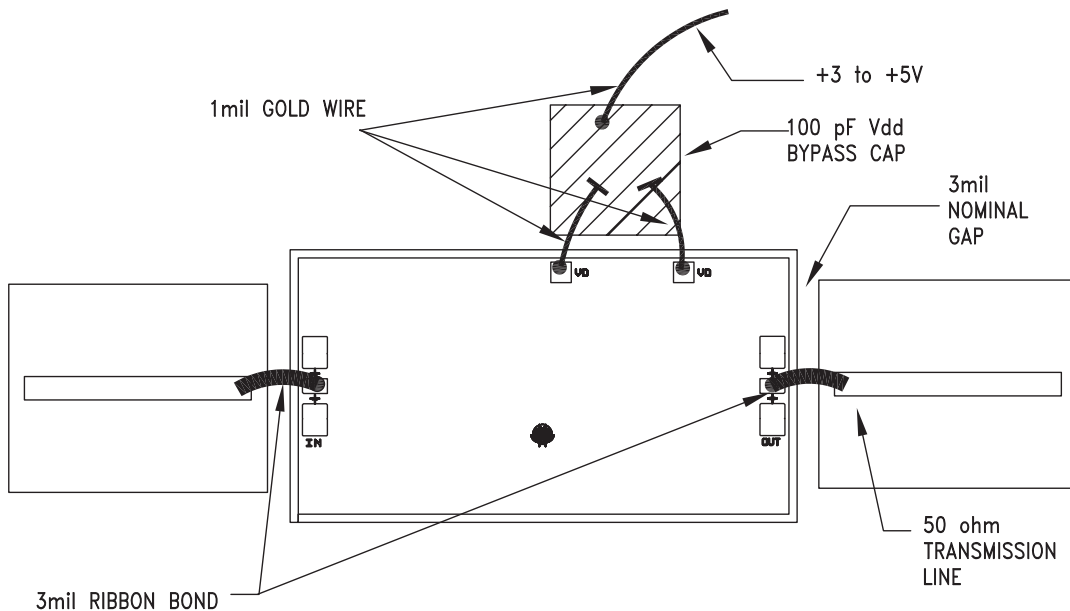

GaAs MMIC LOW NOISE AMPLIFIER, 24 - 36 GHz

Mounting & Bonding Techniques for Millimeterwave GaAs MMICs

The die should be attached directly to the ground plane eutectically or with conductive epoxy (see HMC general Handling, Mounting, Bonding Note).

50 Ohm Microstrip transmission lines on 0.127mm (5 mil) thick alumina thin film substrates are recommended for bringing RF to and from the chip (Figure 1). If 0.254mm (10 mil) thick alumina thin film substrates must be used, the die should be raised 0.150mm (6 mils) so that the surface of the die is coplanar with the surface of the substrate. One way to accomplish this is to attach the 0.102mm (4 mil) thick die to a 0.150mm (6 mil) thick molybdenum heat spreader (moly-tab) which is then attached to the ground plane (Figure 2).

Microstrip substrates should be brought as close to the die as possible in order to minimize bond wire length. Typical die-to-substrate spacing is 0.076mm to 0.152 mm (3 to 6 mils).

An RF bypass capacitor should be used on the Vdd input. A 100pF single layer capacitor (mounted eutectically or by conductive epoxy) placed no further than 0.762mm (30 Mils) from the chip is recommended.

Handling Precautions

Follow these precautions to avoid permanent damage.

Storage: All bare die are placed in either Waffle or Gel based ESD protective containers, and then sealed in an ESD protective bag for shipment. Once the sealed ESD protective bag has been opened, all die should be stored in a dry nitrogen environment.

Cleanliness: Handle the chips in a clean environment. DO NOT attempt to clean the chip using liquid cleaning systems.

Static Sensitivity: Follow ESD precautions to protect against ESD strikes.

Transients: Suppress instrument and bias supply transients while bias is applied. Use shielded signal and bias cables to minimize inductive pick-up.

General Handling: Handle the chip along the edges with a vacuum collet or with a sharp pair of bent tweezers. The surface of the chip has fragile air bridges and should not be touched with vacuum collet, tweezers, or fingers.

Mounting

The chip is back-metallized and can be die mounted with AuSn eutectic preforms or with electrically conductive epoxy. The mounting surface should be clean and flat.

Eutectic Die Attach: A 80/20 gold tin preform is recommended with a work surface temperature of 255 °C and a tool temperature of 265 °C. When hot 90/10 nitrogen/hydrogen gas is applied, tool tip temperature should be 290 °C. DO NOT expose the chip to a temperature greater than 320 °C for more than 20 seconds. No more than 3 seconds of scrubbing should be required for attachment.

Epoxy Die Attach: Apply a minimum amount of epoxy to the mounting surface so that a thin epoxy fillet is observed around the perimeter of the chip once it is placed into position. Cure epoxy per the manufacturer's schedule.

Wire Bonding

Ball or wedge bond with 0.025mm (1 mil) diameter pure gold wire (DC Bias) or ribbon bond (RF ports) 0.076mm x 0.013mm (3 mil x 0.5 mil) size is recommended. Thermosonic wirebonding with a nominal stage temperature of 150 °C and a ball bonding force of 40 to 50 grams or wedge bonding force of 18 to 22 grams is recommended. Use the minimum level of ultrasonic energy to achieve reliable wirebonds. Wirebonds should be started on the chip and terminated on the package or substrate. All bonds should be as short as possible <0.31mm (12 mils).

