

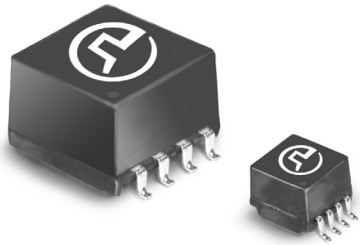

# SMT COMMON MODE CHOKES

for PoE+ Applications



-  RoHS peak reflow temperature rating 245°C
-  Meets IEEE 802.3 specification

Electrical Specifications @ 25°C - Operating Temperature -0°C to +70°C

Part Number <sup>1, 2, 3</sup>	SRF (TYP)	MAX Inter-winding Capacitance (pF)	Leakage Inductance (μH MAX)	OCL (±35%)	DC Resistance (Ω MAX)	Impedance Curves <sup>4</sup>
H6500NL	110 MHz	8	0.12	15 μH	0.15	1
H6501NL	60 MHz	15	0.15	30 μH	0.20	2
H6502NL	42 MHz	18	0.20	60 μH	0.25	3
H6503NL	26 MHz	25	0.25	100 μH	0.30	4
H6504NL	7.0 MHz	10	0.20	250 μH	0.18	5
H6505NL	5.5 MHz	18	0.25	500 μH	0.28	6
H6506NL	2.6 MHz	30	0.30	1 mH	0.35	7
H6507NL	300 MHz	120	1.0	20 mH	1.50	8

**Notes:**

1. Turns Ratio: (1 - 4) : (5 - 8) = 1:1 (±3%)
2. Between channel isolation: 500 VAC @ 60 seconds
3. Polarity: per schematic
4. **For Tape & Reel** packaging, add a "T" suffix to the end of the part number when ordering (i. e. H6500NL becomes H6500NLT).
5. See charts page 2

USA 858 674 8100

Germany 49 7032 7806 0

Singapore 65 6287 8998

Shanghai 86 21 62787060

China 86 755 33966678

Taiwan 886 3 4356768

# SMT COMMON MODE CHOKES

for PoE+ Applications



## Mechanicals

## Schematics

### H6500NL-H6506NL

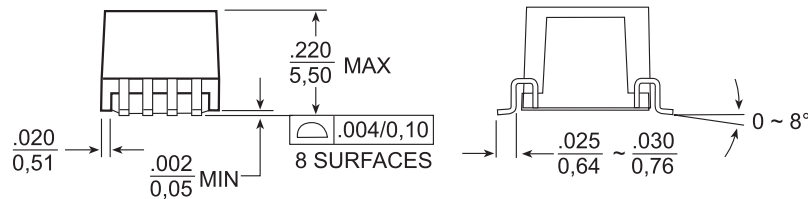
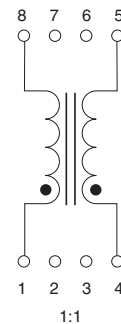
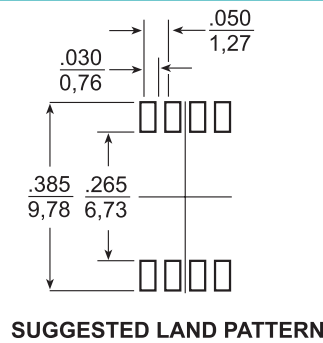
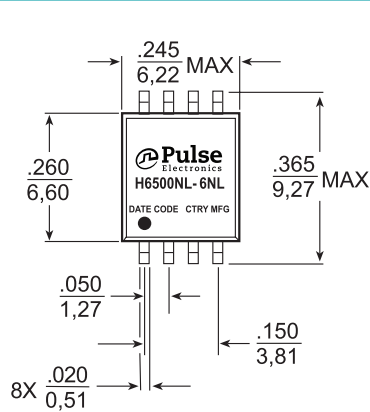

Weight .....0.4 grams      **Dimensions:**  $\frac{\text{Inches}}{\text{mm}}$   
 Tape & Reel .....750  
 Tube .....85      Unless otherwise specified, all tolerances are  $\pm \begin{matrix} .010 \\ 0.25 \end{matrix}$

## Mechanicals

## Schematics

### H6507NL

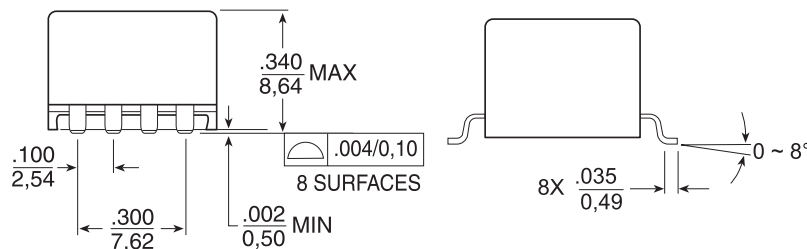
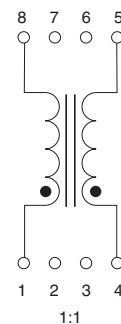
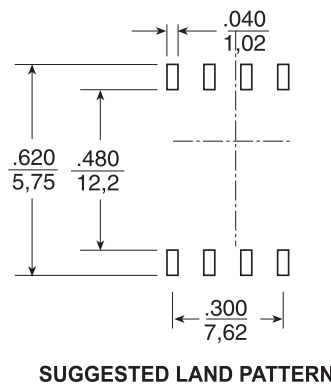
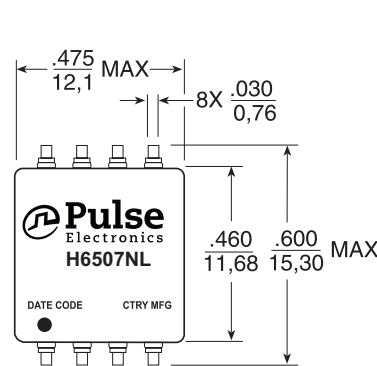

Weight .....1.8 grams  
 Tape & Reel .....250  
 Tube .....40

# SMT COMMON MODE CHOKES

for PoE+ Applications

## Impedance Curves

H6500NL-H6506NL

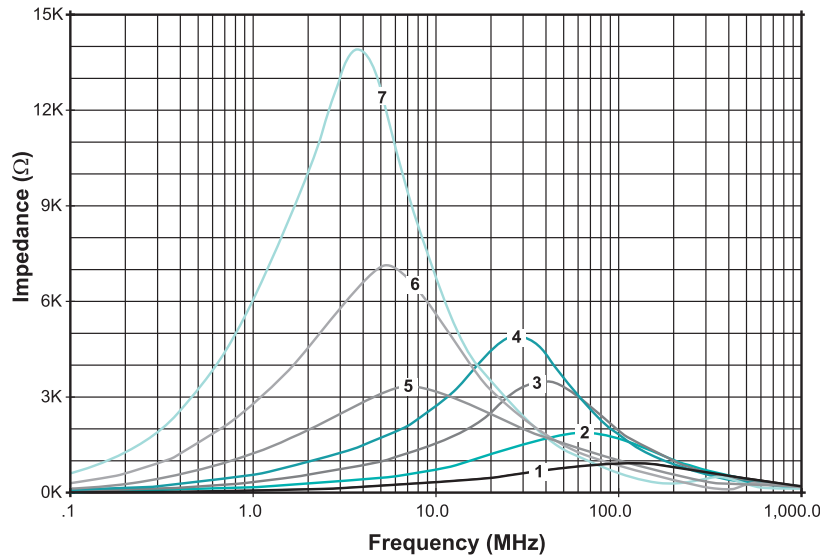

## Impedance Curves

H6507NL

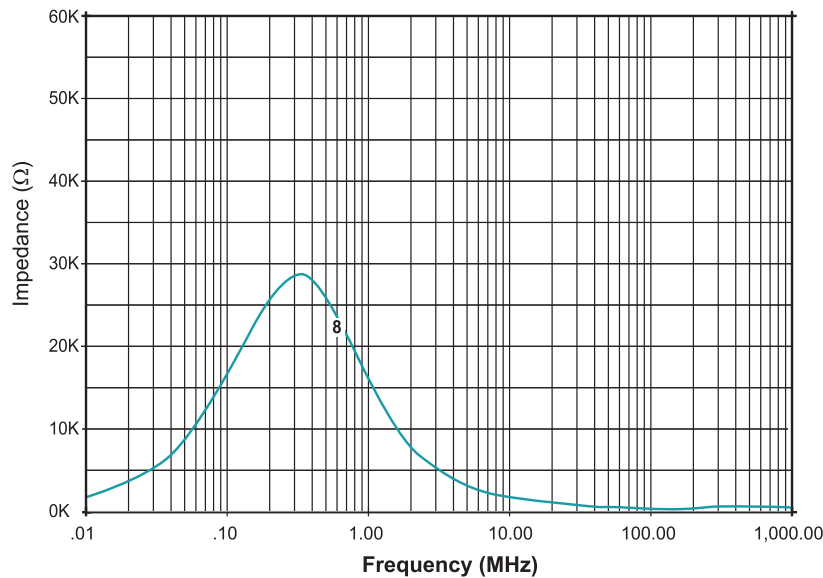

## For More Information

**Pulse Worldwide Headquarters**  
12220 World Trade Drive  
San Diego, CA  
92128  
U.S.A.

Tel: 858 674 8100

**Pulse Europe**  
Einsteinstrasse 1  
D-71083 Herrenberg  
Germany

Tel: 49 7032 7806

**Pulse China Headquarters**  
B402, Shenzhen Academy of  
Aerospace Technol-  
ogy Bldg.  
10th Kejinan Road  
High-Tech Zone  
Nanshan District  
Shenzen, PR China  
518057

**Pulse North China**  
Room 2704/2705  
Super Ocean Finance  
Ctr.  
2067 Yan An Road  
West  
Shanghai 200336  
China

**Pulse South Asia**  
135 Joo Seng Road  
#03-02  
PM Industrial Bldg.  
Singapore 368363

Tel: 65 6287 8998  
Fax: 65 6287 8998

**Pulse North Asia**  
3F, No. 198  
Zhongyuan Road  
Zhongli City  
Taoyuan County 320  
Taiwan R. O. C.  
Tel: 886 3 4356768  
Fax: 886 3 4356823  
(Pulse)

Performance warranty of products offered on this data sheet is limited to the parameters specified. Data is subject to change without notice. Other brand and product names mentioned herein may be trademarks or registered trademarks of their respective owners. © Copyright, 2012. Pulse Electronics, Inc. All rights reserved.